

Last Time:

- Finished discussion of the Khovanov $\rightarrow \widehat{HF}(\mathcal{Z}(L))$ spectral sequence, mentioned its natural generalization to arbitrary surgery diagrams.
- Open Exercises
- Heegaard diagram for manifolds w/ d.

Def: A sutured Heegaard diagram is $(\Sigma, \vec{\alpha}, \vec{\beta})$

- Σ compact surface with $\partial\Sigma \neq \emptyset$ (Σ may be disconnected, but each component Σ_i satisfying $\partial\Sigma_i \neq \emptyset$)
- $\vec{\alpha} = \{\alpha_1, \dots, \alpha_k\}$ is a collection of k curves, lin. ind. in $H_1(\Sigma; \mathbb{R})$
- $\vec{\beta} = \{\beta_1, \dots, \beta_l\}$

Lemma. A sutured H.D. gives rise to a 3-manifold w/ boundary, unique up to homeomorphism.

$$\begin{array}{ccc}
 \text{PF. } \Sigma \times I & \overset{k}{\cup} & D_{\alpha_i}^2 \times I \\
 & \uparrow & \uparrow \\
 & \text{Attached to} & \text{Attached to} \\
 & \Sigma \times \{1\} & \Sigma \times \{1\}
 \end{array}$$

Ex:

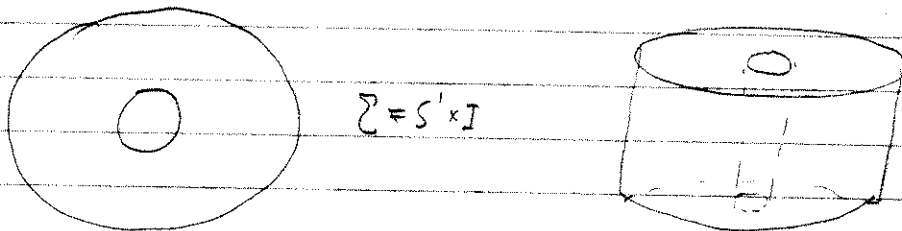

Note: $(\Sigma, \emptyset, \emptyset) \rightarrow \Sigma \times I$.

Ex:

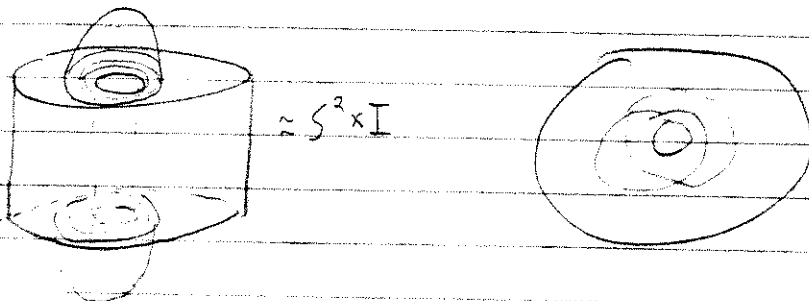

Note: The boundary of the manifolds constructed from a sutured H.D. are naturally divided into 3 pieces.

- (1) $\partial \Sigma \times I$ =: sutures
- (2) $\Sigma \times \{-1\}$, surgered along α =: R_-
- (3) $\Sigma \times \{1\}$, surgered along β =: R_+

Note: Sutures are just annuli. Often, we will conflate an annulus with its core.

Def: We call a 3-manifold w/ boundary, partitioned in this way, a sutured manifold.

We'll denote it (M, δ) , where δ is the sutures.

$$\partial M = R_+ \cup R_-$$

Observe: We orient ∂M in a non-standard way.

Typically, we'd orient ∂M by outward normal first convention.

Here, we're orienting ∂M s.t. R_+ and R_- inherit the orientation from $\Sigma \times I$.

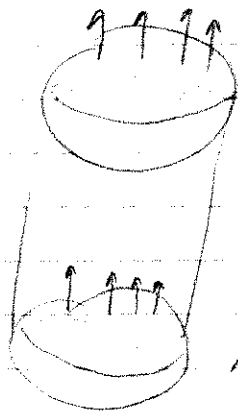

i.e. orientation along R_- (R_+) is such that oriented normal points into M along R_- (out of) (R_+).

Gabai defined sutured manifolds more generally (so ∂M might contain some tori w/ no sutures)

- His motivation was to construct foliations on such manifolds so as to detect

genera of homology classes.

- His technique was to cut (M, δ) along a properly embedded surface $(S, \partial S) \in (M, \partial M)$,

+ construct new sutured decomposition of $(M, \partial M) - (S, \partial S)$

(M', δ') ,

then iterate the construction until obtaining a product sutured manifold,

i.e.

Def: A product sutured manifold is $(\Sigma \times I, \partial \Sigma)$

"

(M, δ)

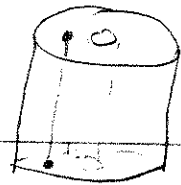

Note: A product sutured manifold has a taut foliation,
 i.e. a foliation w/ a properly embedded arc that transversely intersects every leaf.

Gabai is able to glue back product sutured manifold (w/ taut foliations) together while simultaneously gluing the leaves of the foliation.

If you have a taut foliation on a manifold with $(S, \partial S) \hookrightarrow (M, \partial M)$
 a compact leaf, then

$$-X(S) = \max_{S'} \left\{ -X(S') \mid \begin{array}{l} S' \subset M \\ [S, \partial S'] = [S, \partial S] \end{array} \right\}$$

Lemma: Given (Σ, α, β) a sutured H.D., and the associated sutured manifold (M, γ) .
 Then $X(R_+) = X(R_-)$.

Pf: $X(R_-) = X(\Sigma) + 2 \sum_{\alpha_i \in \alpha} k_i = X(R_+)$,
 because each surgery increases X by 2.

Question: Suppose (Σ, α, β) is a sutured diagram, (not possibly different # of curves in α, β).

$$\begin{array}{l} \text{Sym}^k(\Sigma) \quad \forall k \in \min\{|\alpha|, |\beta|\} \\ \cup \quad \cup \\ \Pi_A \quad \Pi_B \end{array} \quad \begin{array}{l} A \in \{\alpha_1, \dots, \alpha_n\} \\ B \in \{\beta_1, \dots, \beta_m\} \end{array} \quad |A| = |B| = k$$

What, if anything, is $H\mathbb{F}_+(\text{Sym}^k(\Sigma), \Pi_A \cap \Pi_B)$ telling us?
 e.g. For knot complements or Seifert surface complements,
 do these groups contain information about the Alexander module
 outside of its order (the Alexander polynomial)?

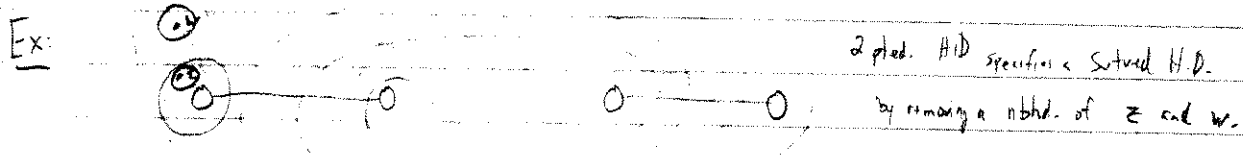

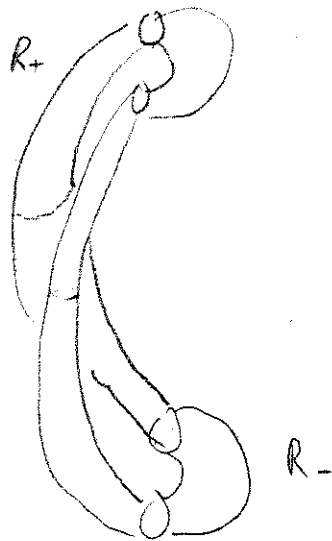
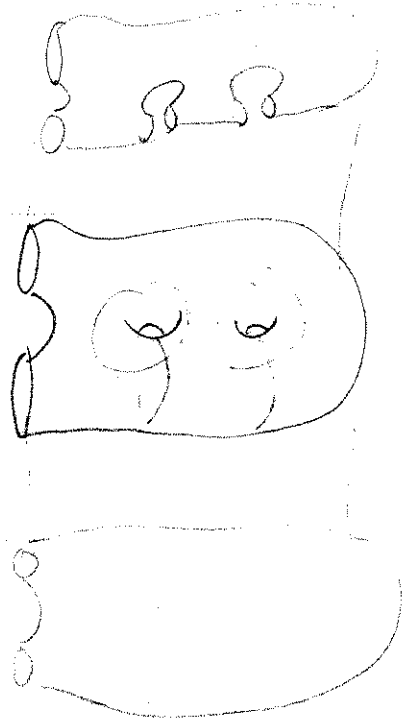

So, doubly pted H.D. gives a sutured manifold w/ torus boundary & 2 parallel sutures. Call it $(Y(K), Y_2)$
Exercise: Check that $(Y(K), Y_2) \cong (Y\text{-nbhd}(K), 2 \text{ meridional sutures})$

Ex: Let $F \in Y\text{-nbhd}(K)$ be a Seifert surface.
 $(Y(K) - \text{nbhd}(F), \partial F)$

$((S^3 - \text{Torus}) \setminus \text{Seifert surface})$

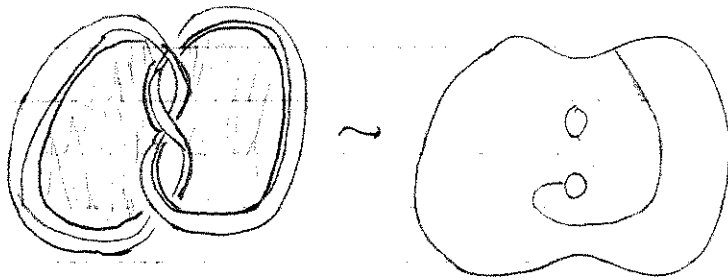

gives 2 handlebody w/ a curve (sutures) on it.

Ex: Y closed 3-manifold.

Consider $(M = Y - B^3, \gamma = \text{s.c.c. on } \partial B)$

Note: HD for $(Y - B^3, \gamma)$ is simply a pted HD for Y^3 in the sense of this class.

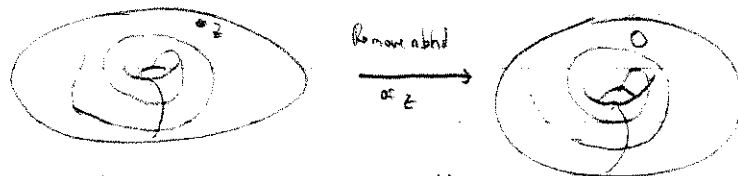

(See Andras Juhász' "Holo. disks + sutured manifolds.")

Given $(\Sigma, \vec{z}, \vec{\beta})$ sutured H.D.,

Def. $C(\Sigma, \vec{z}, \vec{\beta}) = \bigoplus_{\vec{k} \in \mathbb{T}_\omega \cap \mathbb{T}_\beta \in \text{Sym}^k(\Sigma)} \mathbb{F}\langle \vec{k} \rangle$

$$\partial \vec{\Psi} = \sum_{\phi \in \pi_2(\vec{k}, \vec{y})} \# \widehat{M}(\phi) \cdot \vec{y}$$

$M(\phi) = 1$
 $\vec{y} \in \mathbb{T}_\omega \cap \mathbb{T}_\beta$.

Thm. (Johász)

- $\partial^2 = 0$
- Any (balanced, i.e. $X(R_+) = X(R_-)$) sutured manifold has a sutured H.D., and if two sutured H.D. $(\Sigma, \vec{z}, \vec{\beta}) ; (\Sigma', \vec{z}', \vec{\beta}')$

class of sutured manifolds on which Reidemeister torsion is defined.

specify equivalent (diffeomorphic) sutured manifolds, then

$$H_* (C(\Sigma, \vec{z}, \vec{\beta})) \cong H_* (C(\Sigma', \vec{z}', \vec{\beta}'))$$

Def. $SFH(M, \sigma) := H_* (C(\Sigma, \vec{z}, \vec{\beta}), d)$ for some $(\Sigma, \vec{z}, \vec{\beta})$ specifying (M, σ) .

Pf. $\partial^2 = 0$ is easy. (Just like before, but easier because we're counting fewer hyper-surfaces.)

Uses Gromov compactness like:

In \widehat{HF} or \widehat{SFH} , avoiding $V_z = z \times \text{Sym}^{k-1}(\Sigma)$ for any z endpoint

⇒ No J -holomorphic sphere bubbling.

Badness happens when $\pi_2(\text{Sym}^k(\Sigma)) \neq 0$

$$\pi_2(\text{Sym}^k(\Sigma), \mathbb{T}_\omega) \neq 0$$

$$\pi_2(\text{Sym}^k(\Sigma), \mathbb{T}_\beta) \neq 0$$

Here, $\pi_2(\text{Sym}^k(\Sigma)) \cong \mathbb{Z}\langle S \rangle$ sat.

$$S \cap V_z = \pm 1 \quad \forall z \in \Sigma$$

$$\pi_2(\text{Sym}^k(\Sigma), \mathbb{T}_\omega) = \mathbb{Z}\langle S' \rangle$$

$$\pi_2(\text{Sym}^k(\Sigma), \mathbb{T}_\beta) = \mathbb{Z}\langle S'' \rangle$$

Invariance Pf.

We already proved this.

Sketch: Any two diagrams for (M, δ) can be connected by

- isotopies
- handle slides
- stabilizations

} Cost Theory

Verified that these moves don't change $SFH(Y^3-B, \chi)$

||
 $\widehat{HF}(Y)$

Matt Hedden HFH 4/12/11

Last Time:

Defined $SFH = H_*(C(\Sigma, \vec{\alpha}, \vec{\beta}), \partial)$, where
 $(\Sigma, \vec{\alpha}, \vec{\beta})$ is a Heegaard diagram adapted to a balanced sutured manifold.
 (i.e. $\chi(R_+) = \chi(R_-)$)
 $(C(\Sigma, \vec{\alpha}, \vec{\beta})$ comes from $\vec{\alpha} \in \Pi_\alpha \cap \Pi_\beta \subseteq \text{Sym}^{|\vec{\alpha}|=|\vec{\beta}|} \Sigma$.)

Note, again, our sutured manifolds satisfy $\pi_0(X) \rightarrow \pi_0(\partial M)$

Concretely, this restriction means that all components of
 $(\Sigma \setminus \vec{\alpha})$ or $(\Sigma \setminus \vec{\beta})$ contain $\partial \Sigma$.

Ex:

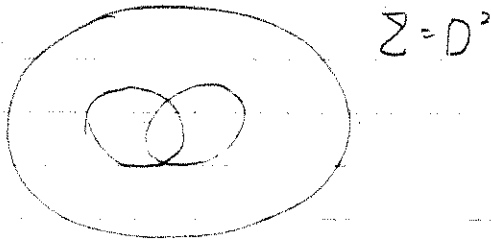

This condition is not met.

So, we get

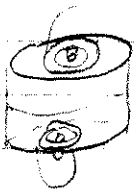

which has sphere boundary components with no sutures.

We don't allow this.

Ex:

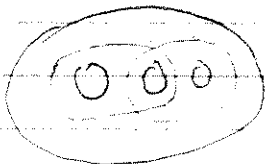

Σ - three punctured disk

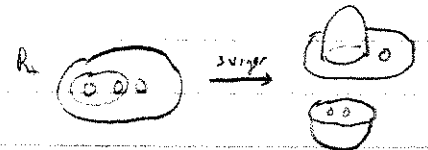

\sim

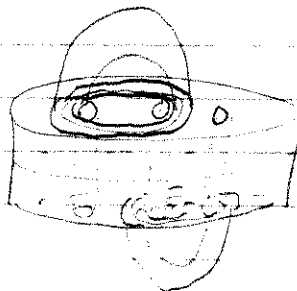

\approx

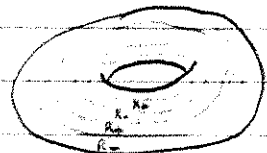

Note: $(M, \gamma) \cong (M', \gamma')$

if \exists diffeomorphism of M to M'

↗ sending γ to γ'

orientation-preserving

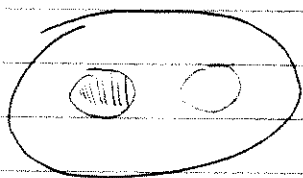

$$\rightsquigarrow \text{Sym}^2(D^2)$$

$$\cup \cup$$

$$\alpha \quad \beta$$

$$\pi_2(D) \cong 0$$

But $\pi_2(D, \alpha) \cong \pi_2(D, \beta) = \mathbb{Z}$

Having $\pi_2(M^{2n}, \text{Lagrangian}) \neq 0$ is bad for Floer homology due to "bubbling"

This is why it's important that every boundary component contains sutures.

Observation: A link complement can be equipped w/ a sutured manifold structure by taking 2 parallel meridional sutures on each boundary.

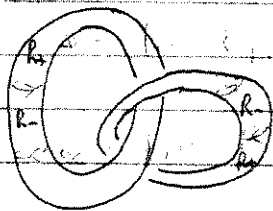

Drawing a H.D. for a link complement in this way,

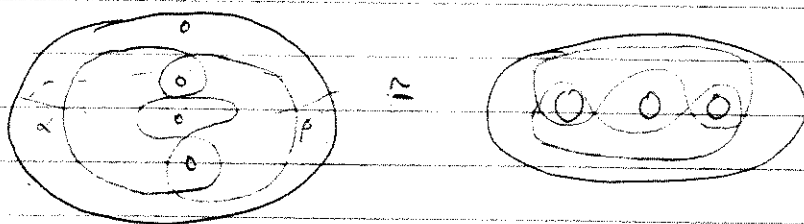

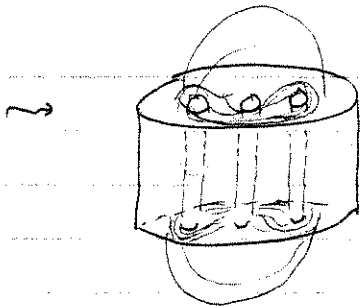

One can see the Hopf link by tracking a longitude for each torus boundary component intersecting each suture once.

Note that they link once.

∂ :



~~modular form~~

Define: $\widehat{HFL}(L) = SFH(Y-n(L), \gamma)$

↑
two parallel meridional sutures
on each component.

Thm. $\chi(\widehat{HFL}(L))$

$$= \prod_{i=1}^{|L|} (T_i^{\frac{1}{2}} - T_i^{-\frac{1}{2}}) \cdot \Delta_L(T_1, \dots, T_{|L|})$$

For $|L| > 1$

$$\pi_1(S^3 - n(L)) \xrightarrow{\phi} H_1(S^3 - L) \cong \mathbb{Z}^{|L|} \leftarrow \begin{array}{l} \text{generated by} \\ \text{meridians} \end{array}$$

$$\Delta_L = \det \left(\text{presentation matrix for } H_1(X_\infty^L; \mathbb{Z}[T_1, T_1^{-1}, \dots, T_{|L|}, T_{|L|}^{-1}]) \right)$$

Ex: (Hopf Link, cont'd.)

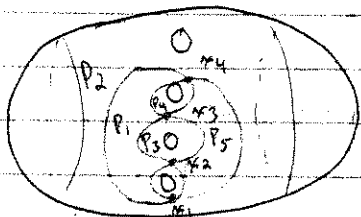

$$\pi_2(K_i, K_j) \cong \begin{cases} \emptyset & \mathcal{E}(K_i, K_j) \neq 0 \\ \mathbb{Z} & \mathcal{E}(K_i, K_j) = 0 \end{cases}$$

If $\pi_2(K_i, K_j) \neq \emptyset \Rightarrow$

\vec{x}

$$\left\{ \begin{array}{c} F^2 \xrightarrow{\pi} \Sigma \\ \downarrow \pi \\ \mathbb{D}^2 \end{array} \right\} \rightsquigarrow D(\gamma) = \sum n_i(\gamma) \cdot D_i$$

$$\partial D(\gamma) = \gamma_\alpha \cup \gamma_\beta =: \gamma$$

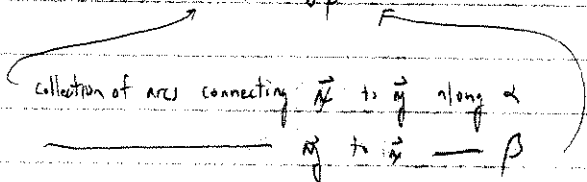

collection of arcs connecting \vec{x} to \vec{y} along α

\vec{y} to \vec{x} — β

$\gamma = \partial D(\gamma)$, i.e. ∂ null-homologous.

In the case at hand, $D(\gamma)$ has $n_{P_i}(D(\gamma)) = 0$ in all

P_i regions adjacent to $\partial \Sigma$.

(Think of $\partial \Sigma$ as basepoints.)

$$\mathcal{E}(\vec{x}, \vec{y}) = [\gamma] \in H_1(\Sigma) / \text{Span } \alpha + \text{Span } \beta$$

Can this be the boundary of a domain of a Whitney disk?

~~$$H_1(\Sigma, \partial \Sigma) / \text{Span } \alpha + \text{Span } \beta$$~~

$\therefore \mathcal{E}(K_i, K_j) \in H_1(M)$.

What if $\mathcal{E}(\vec{x}, \vec{y}) = 0 \in H_1(M)$?

Then we can find $D(\gamma)$ s.t. $\partial D(\gamma) = \gamma + \sum n_i \alpha_i + \sum m_j \beta_j$

$\rightarrow D(\gamma)$ is domain of Whitney disk.

How many Whitney disks are there?

Suppose $\gamma, \gamma' \in \pi_2(\bar{x}, \bar{y})$.

Then $\gamma' * \gamma^{-1} \in \pi_2(\bar{y}, \bar{y}) = \{ \text{null-homologies between } \alpha + \beta \text{ curves in } H_1(\Sigma) \}$

i.e. $\text{Ker}(\text{Span } \alpha + \text{Span } \beta \rightarrow H_1(\Sigma))$

i.e. Periodic domains.

($M=Y$)

Payer-Vietoris $\cong H_2(M)$.

Lemma. $\pi_2(\bar{x}, \bar{y}) = \begin{cases} \phi & \Sigma(\bar{x}, \bar{y}) \neq 0 \in H_1(M) \\ H_2(M) & \Sigma(\bar{x}, \bar{y}) = 0 \end{cases}$

↑ No extra \mathbb{Z} , because

the characteristic class of the surface

∂ in $H_2(\Sigma, \partial\Sigma)$, not $H_2(\Sigma)$

||

$\mathbb{Z}\langle [\Sigma, \partial\Sigma] \rangle$.

$\pi_1([\Sigma, \partial\Sigma]) \neq 0$ for

P_i adjacent to $\partial\Sigma$.

$$H_1(M) \cong H_1(\Sigma) / \text{Span } \alpha + \text{Span } \beta \cong \mathbb{Z}\langle A \rangle \oplus \mathbb{Z}\langle B \rangle \oplus \mathbb{Z}\langle C \rangle / \langle A+C=0 \rangle \langle A-C=0 \rangle$$

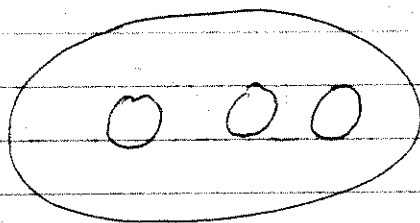

$$\cong \mathbb{Z}\langle A=-C \rangle \oplus \mathbb{Z}\langle B \rangle$$

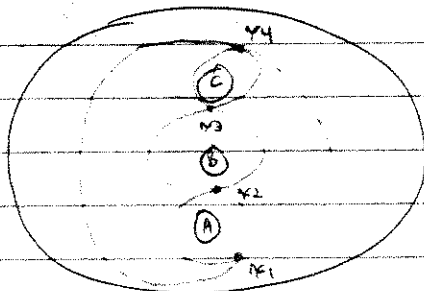

$$\Sigma(x_1, x_2) = \left[\begin{array}{c} x_2 \\ \circlearrowleft \in \delta \\ x_1 \end{array} \right] \in H_1(M)$$

$$\llbracket A \rrbracket \neq 0$$

$$\Sigma(K_2, K_3) = \left[\begin{array}{c} \text{Diagram of link } K_2 \text{ and } K_3 \end{array} \right] = [B] \neq 0.$$

$$\Sigma(K_3, K_4) = \left[\begin{array}{c} \text{Diagram of link } K_3 \text{ and } K_4 \end{array} \right] = [C] \neq 0$$

~~So, linking disks are transitive~~

If $\Sigma(\vec{x}, \vec{y}) \neq 0$ and $\Sigma(\vec{y}, \vec{z}) \neq 0 \not\Rightarrow \Sigma(\vec{x}, \vec{z}) \neq 0$.

Ex: $\Sigma(\vec{x}, \vec{y}) \neq 0$, $\Sigma(\vec{y}, \vec{z}) \neq 0$, but $\Sigma(\vec{x}, \vec{z}) = 0$.

But Σ -class is additive, so we can conclude that there are no Whitney disks at all!

$$SFH(S^3 - n(\text{Hopf Link}), \gamma) \cong \mathbb{F} \oplus \mathbb{F} \oplus \mathbb{F} \oplus \mathbb{F}.$$

Observe: $SFH(M, \gamma) \cong \bigoplus_{\Sigma\text{-classes}} SFH(M, \gamma; \epsilon)$

$\Sigma\text{-classes}$

$\updownarrow \pm 1$

$$H_1(M) \cong H^2(M, \partial M)$$

$\cong \mathbb{R}$

$$\mathbb{Z}\langle A, -C \rangle \oplus \mathbb{Z}\langle B \rangle$$

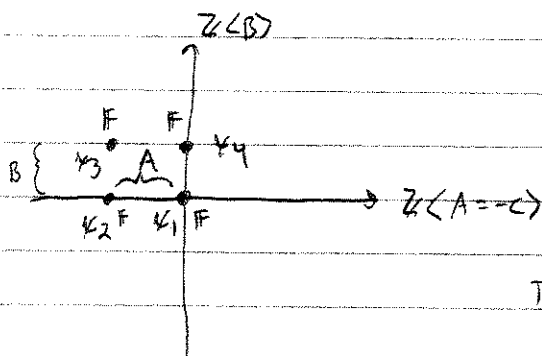

The choice of placing K_1 was arbitrary, but the differences determined the relative placements of the rest of the generators.

Thus, the picture is unique up to overall translation.

Regard $\chi(SFH(M, \gamma)) \in \mathbb{Z}[H_1(M)]$.

In this example, $\mathbb{Z}[H_1(M)] \cong \mathbb{Z}[\mathbb{Z}\langle A \rangle \oplus \mathbb{Z}\langle B \rangle]$

well-defined up to mult.

by units, i.e.

$$\pm T_A^n T_B^m.$$

$$\mathbb{Z}[T_A, T_A^{-1}, T_B, T_B^{-1}]$$

$$\chi(SFH(\text{Hopf})) = \pm T_B^1 T_A^0 \pm T_B^0 T_A^0 \pm T_B^0 T_A^{-1} \pm T_B^0 T_A^{-1}$$

Last time: Defined $\widehat{HFL}(L)$ as $SFH(Y-n(L), 2 \text{ meridional sutures on each component})$

Computed $\widehat{HFL}(\text{Hopf Link})$

Discussed $E(\vec{x}, \vec{y}) = [\gamma] \in H_1(M) \cong H^2(M, \partial)$
 $\gamma_a \cup \gamma_b$

Lemma $E(\vec{x}, \vec{y}) = 0 \Leftrightarrow \pi_2(\vec{x}, \vec{y}) \neq \emptyset$

Lemma $E(\vec{x}, \vec{y}) = 0 \Rightarrow \pi_2(\vec{x}, \vec{y}) \cong H_2(M)$

Note: For $\widehat{HFL}(L \subseteq S^3)$, $H_2(S^3 - L) = 0$.

This fact gives a (non-canonical) splitting
 $SFH(M, \gamma) \cong \bigoplus_{\alpha \in H_1(M)} SFH(M, \gamma; \alpha)$

Given $Y^3 \xrightarrow{\text{remove } B^3} (Y - B^3, \gamma)$

$SFH(Y - B^3, \gamma) \cong \widehat{HF}(Y)$

$\hookrightarrow H_1(Y - B^3) \cong H_1(Y)$

(No new information.)

One has basepoint, one has boundary component
 otherwise, some H.D.)

$Y^3 \xrightarrow[\text{B}^3\text{'s}]{\text{remove two}} (Y^3(2), \gamma)$

HD for $(Y(2), \gamma)$

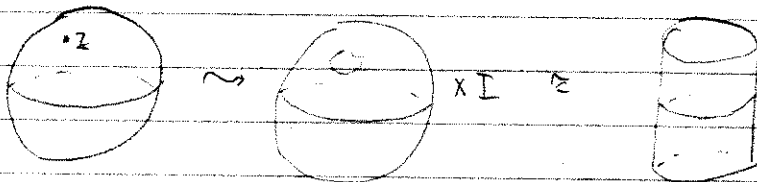

$\text{pt.} = \text{Sym}^0(\mathbb{Z}) \cong \text{Sym}^0(\phi_\alpha) \cong \text{Sym}^0(\phi_\rho)$

$SFH(S^3(1), \gamma) \cong \mathbb{Z} \langle \text{pt.} \rangle$

$\hookrightarrow (M, \partial) \text{ be } (\mathbb{Z} \times I, \partial \mathbb{Z} \times \{0\})$ a sutured manifold. $\Rightarrow SFH(M, \gamma) \cong \mathbb{Z}$.

This fact will, ultimately, prove that $\widehat{HFK}(K, g(K)) \cong \mathbb{Z}$ for a fibred knot.

Exercise: Show this.

(Recall: $HF^+(Y|_P, 2g-2) \cong \mathbb{Z}$)

Hint: Construct HD from the fibration $F^2 \times I \cup F^2 \times I$

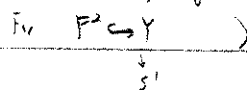

Thm. $SFH(Y-K, 2 \text{ meridians}) \cong \widehat{HFK}(Y, K)$

Pf. We did it!

$$\begin{aligned} \widehat{CFK}(Y, K) &= (C(\Sigma, \vec{z}, \vec{\beta}, \mathbb{Z}, W), \hat{\partial}) \\ &= (C(\Sigma - n(E, W), \vec{z}, \vec{\beta}), \partial^{SFH}) \\ &= SFH(Y-K, M) \end{aligned}$$

$$(Y-n(K), M) \xrightarrow[\text{Seifert surface}]{\text{decompose along}} ((Y-n(K)) - F, \partial F)$$

\mathbb{R}
 $Y-n(F)$
 Spin^c or Alexander grading
 ↓
 grading

Thm $SFH(Y-n(F), \partial F) \cong SFH(Y-n(K), M; g(F))$

AD for $(S^3(2), Y_2)$?

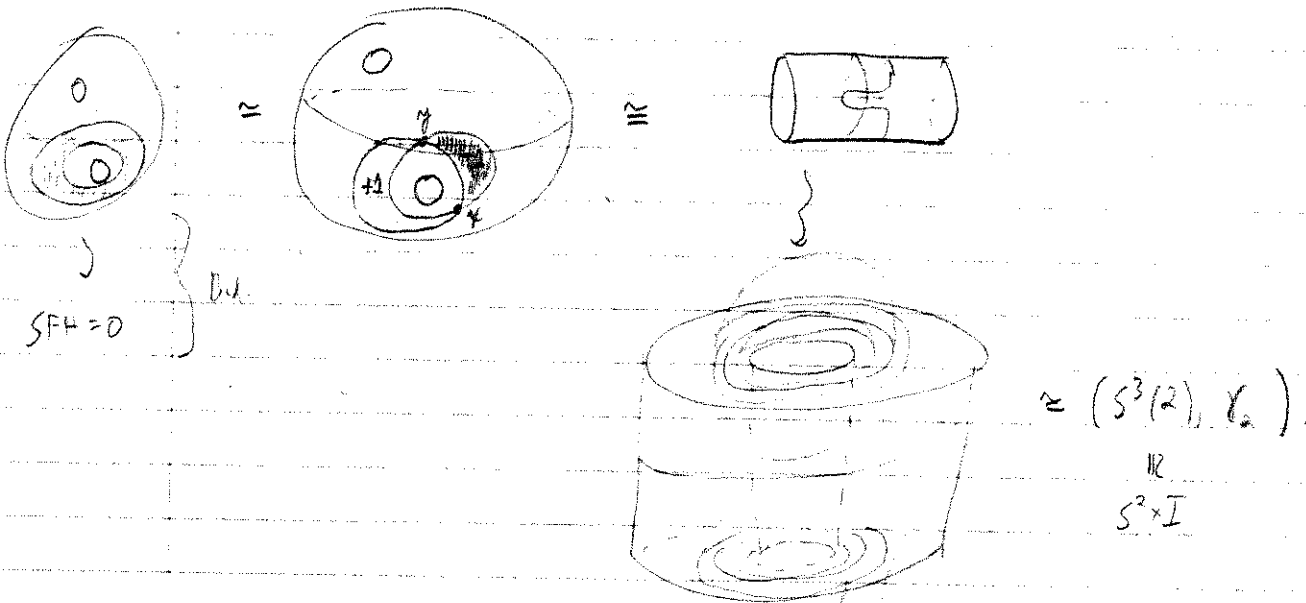

$$C(\Sigma, \alpha, \beta) \cong \mathbb{F}\langle x \rangle \oplus \mathbb{F}\langle y \rangle$$

$$E(x, y) = 0$$

$$H_2(S^3(2), Y_2) \cong \mathbb{Z}$$

\exists 2 unitary disks from y to x , each with unique J-holomorphic reps. (by RMT)

$$\partial y = 2x = 0 \in \mathbb{F}$$

$$gr(\vec{y}) - gr(\vec{x}) = \mu(\phi)$$

$$\Rightarrow SFH(S^3(2), Y_2) \cong V = \mathbb{F} \oplus \mathbb{F}_{i=1}^{i=2}$$

works for some V as in Casson's talk

Note: If $H_2(M) \neq 0$, we need an admissibility hypothesis

We need weak admissibility, i.e.

Every periodic domain has both positive and negative coefficients.

Ex: $(Y^3(n), \gamma_n)$

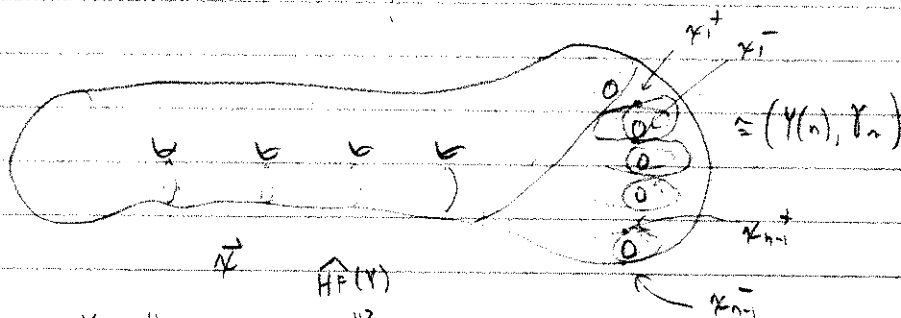
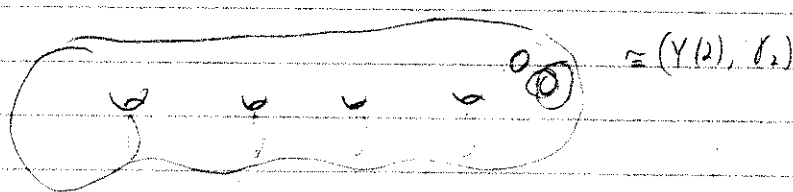
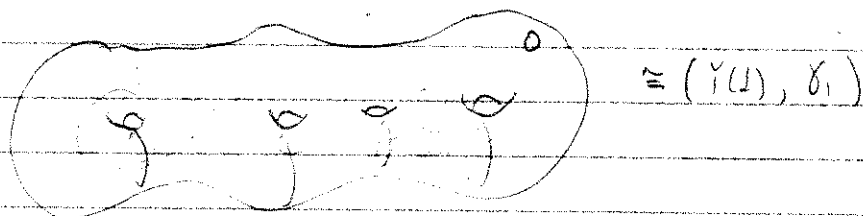

Kunnet
Formula

$$\widehat{HF}(Y) \cong SFH(Y(n), \gamma_n) \cong SFH(Y(1), \gamma_1) \otimes V^{n-1}$$

$$\mathbb{Z} \otimes \gamma_1^+ \otimes \dots \otimes \gamma_{n-1}^+$$

Def. An n-pled. H.D. for $Y \parallel (\Sigma_g, \{\alpha_1, \dots, \alpha_{g(n-1)}\}, \{\beta_1, \dots, \beta_{g(n-1)}\}, w_1, \dots, w_n)$

s.t. (1) Σ closed, oriented surface.

(2) $\vec{\alpha}$ disjoint, s.c.c. spanning $\mathbb{R}^g \subseteq H_1(\Sigma_g, \mathbb{R}) \cong \mathbb{R}^{2g}$

(3) $\vec{\beta}$

(4) Every component of $\Sigma \cdot \vec{\alpha}$ contains a w_i , and

$$\Sigma \cdot \vec{\beta} = \dots$$

Observe: These HD's can be interpreted / constructed by Morse theory through Morse functions s.t. \exists $g+n-1$ index 1 critical pts. self-indexing

$g+n-1$	-	2	_____
n	-	0	_____
n	-	3	_____

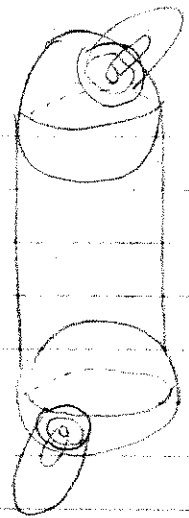
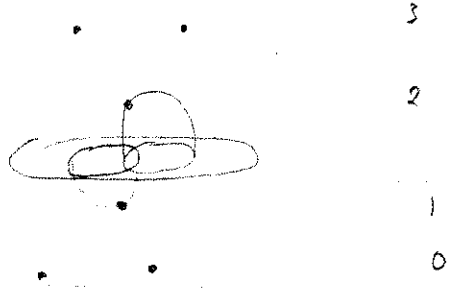
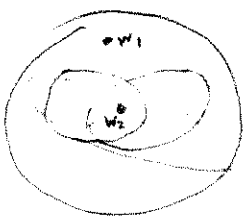

$\cup 2 B^3$'s

From such an n-plet HD, we can define Floer complexes

$$\tilde{C}(\Sigma, \vec{\alpha}, \vec{\beta}, \vec{w}) = \bigoplus_{\vec{k} \in \mathbb{N}^n} F\langle \vec{k} \rangle$$

$$\tilde{\partial} \vec{k} = \sum_{\phi} \sum_{\substack{\# M(\phi) \\ n w_i(\phi) = 0 \quad \forall i=1, \dots, n}} \# M(\phi) \cdot \vec{m}$$

SFH($Y(n), \vec{w}_n$)

\uparrow $H_*(\tilde{C}, \tilde{\partial})$ is an invariant of Y - it is isomorphic to $\widehat{HF}(Y) \otimes V^{n-1}$

which is an invariant of $(Y(n), \vec{w}_n)$

$$C^-(\Sigma, \vec{\alpha}, \vec{\beta}, \vec{w}) = \bigoplus_{\vec{x} \in \text{TP}} \mathbb{F}[U_1, \dots, U_n] \langle \vec{x} \rangle, \quad \partial^-(x) = \sum_{\phi} \sum_{\phi} \# M(\phi) \cdot U_1^{m_1(\phi)} \dots U_n^{m_n(\phi)}$$

etc.

Thm $\partial^- \circ \partial^- = 0$.

and $H_x(C^-, \partial^-) \cong HF^-(Y)$

$$\begin{array}{ccc} \uparrow & & \uparrow \\ \mathbb{F}[U_1, \dots, U_n] & & \mathbb{F}[U] \end{array}$$

\uparrow
 $\mathbb{F}[U]$, where
 U acts as U_i .

$$(U_i)_* \cong (U_j)_* \quad \forall i, j$$

$$\begin{array}{ccc} H_x(C^-, \partial^-) & \xrightarrow{\cong} & H_x(C^-, \partial^-) \\ \downarrow (U_i)_* & & \downarrow (U_i)_* \end{array}$$

$$H_x(C^-, \partial^-) \xrightarrow{\cong} H_{x-2}(C^-, \partial^-)$$

Exercise:

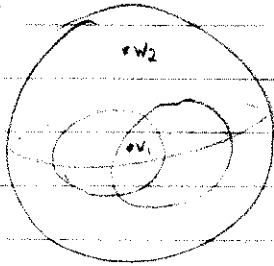

compute (C^-, ∂^-) .

LATE



$$\pi_2(\kappa, \kappa) \cong \mathbb{Z}\langle \Sigma \rangle \oplus H_2(Y)$$

$$C^- = \mathbb{F}[U, V_2] \langle \kappa_1 \rangle \oplus \mathbb{F}[U, V_2] \langle \kappa_2 \rangle$$

$$\partial^- \kappa_1 = 1 \cdot \kappa_2 + 1 \cdot \kappa_2 = 0$$

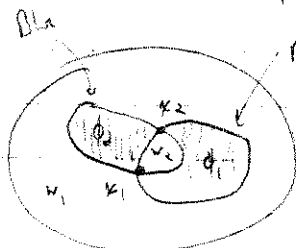

$$\pi_2(\kappa, \kappa) \cong \pi_2(\text{Sym}^2(\Sigma)) \oplus \text{Periodic Domains} \cong \mathbb{Z} \left(\begin{array}{l} \text{if } g \geq 2 \\ H_2(Y) \end{array} \right) \cup \mathbb{K}_2 \{ \text{Span } \vec{\alpha} + \text{Span } \vec{\beta} \rightarrow H_1(\Sigma) \}$$

$$\bar{I} \text{- Ex. } \{ \text{Parallel Domains} \} \cong \mathbb{Z}\langle A \rangle \oplus \mathbb{Z}\langle B \rangle \oplus \mathbb{Z}\langle S^2 \rangle \subset \pi_2(\text{Sym}^2(S^2))$$

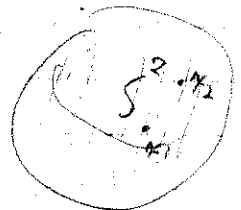
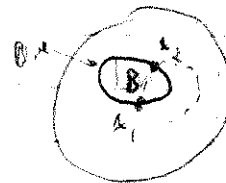
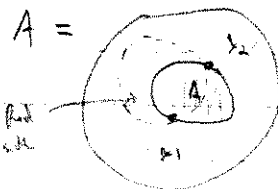

So any $\phi \in \pi_2(\kappa, \kappa_2)$ differs from ϕ_1 by adding $nA + mB + rS^2$, $n, m, r \in \mathbb{Z}$.

$$\text{Nbk: } \mu(nA + mB + rS^2) = n\mu(A) + m\mu(B) + r\mu(S^2)$$

$$\text{Suppose } \phi' = \phi_1 + (nA + mB + rS^2) \quad \mu(\phi') = 1$$

$$\Rightarrow 2n + 2m + 4r = 0$$

$$\text{We also need } n_{p_i}(\phi') \geq 0 \quad \forall p_i \in S^2 \setminus \{x, y\}$$

$$n_{p_i}(\phi') = 0 + 0 + 0 + r n_{p_i}(S^2)$$

||
r

$$\text{So } r \geq 0$$

$$\begin{aligned}
 n_{p_2} &= 0 + m + 0 + r \stackrel{!}{=} 0 \\
 n_{p_3} &= 0 + n + m + r \geq 0 \\
 n_{p_4} &= 1 + 0 + n + r \geq 0
 \end{aligned}$$

Lemma. If $\mu(\phi') = 1$ & $n_{p_i} \geq 0 \forall i=1, \dots, 4$,
 Then $\phi' = \phi_2$ or $\phi' = \phi_1$.

Pf. $r \geq 0 + r \geq -n - m$
 hence

$$\begin{aligned}
 4r + 2(n+m) &= 0 \Rightarrow 2r = -n - m \Rightarrow r \geq 2n \Rightarrow r \leq 0. \\
 &\Rightarrow r = 0.
 \end{aligned}$$

positively forces $n = -m$.

This now verifies that $\partial^- \kappa_1 = \mathbb{1} \cdot \kappa_2 + \mathbb{1} \cdot \kappa_2 = 0$.

$$\partial^- \kappa_2 = ?$$

Def

Lemma. $\partial^- \kappa_2 =$

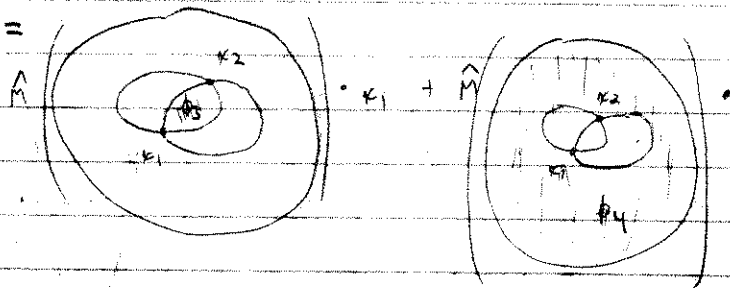

$$\partial^- \kappa_2 = \widehat{m} \left(\begin{matrix} \cdot \\ \cdot \\ \cdot \end{matrix} \right) \cdot U_1 \cdot U_2 \cdot \kappa_1 + \mathbb{1} \cdot U_1 \cdot U_2 \cdot \kappa_1$$

$$= U_1 \cdot U_2 \cdot \kappa_1 + U_1 \cdot \kappa_1$$

$$\partial^- \kappa_2 = (U_2 + U_1) \kappa_1$$

PI Symmetry of the previous argument which ~~rather~~ ruled out all other holomorphic disks
 by (Maslov index + positivity)

the homology

$$\begin{aligned}
 & \begin{array}{c} \partial^- \\ \parallel \\ U_1 + U_2 \end{array} \\
 & \mathbb{F}[U_1, U_2] \langle \kappa_2 \rangle \xrightarrow{\partial^-} \mathbb{F}[U_1, U_2] \langle \kappa_1 \rangle \xrightarrow{\partial^-} 0 \\
 & H_*(C^-) \cong \ker \frac{\partial^-}{\text{Ind}^-} \\
 & \cong \frac{\mathbb{F}[U_1, U_2] \langle \kappa_1 \rangle}{\langle U_1 + U_2 \rangle} \\
 & \stackrel{(\text{mod } 2)}{\cong} \mathbb{F}[U] \cong HF^-(S^3)
 \end{aligned}$$

This example is a model for the general case:

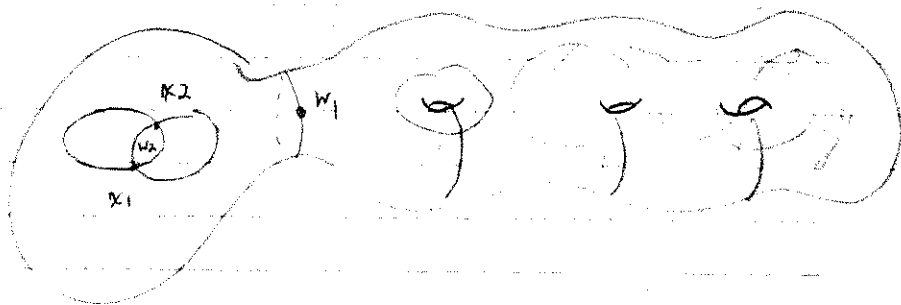

We've shown that 0-3 stabilizing the 1-ptcd. genus zero diagram of S^3 leaves $H_*(C^-)$ unchanged as an $\mathbb{F}[U]$ -module.

Algebraically, the proof of 0-3 stab. invariance is following.

C^- original H.D.'s complex

$$C_{03}^- \text{ stabilized H.D.'s complex} \cong C^-[U_1] \langle \kappa_1 \rangle \oplus C^-[U_2] \langle \kappa_2 \rangle$$

Claim: $(C_{03}^-, \partial^-) \cong (C^-[U_1] \langle \kappa_1 \rangle \oplus C^-[U_2] \langle \kappa_2 \rangle, \partial^-)$

Note: $H_*(\text{RHS}) \cong H_*(C^-[U_2] \langle \kappa_2 \rangle)$, via (U_1, U_2) .

Claim: $(C_{03}^-, \partial^-) \cong$
 $M(U_1 + U_2) \leftarrow \text{Mapping cone complex of } U_1 + U_2 : (C^-[U_2] \langle \kappa_2 \rangle, \partial^-) \rightarrow (C^-[U_2] \langle \kappa_2 \rangle, \partial^-)$
 $\cong H_*(M(U_1 + U_2)) \cong H_*(C^-) \oplus \mathbb{F}[U]$

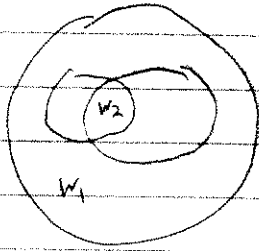

$$\vec{\sigma} \equiv 0$$

↑ counts only disks avoiding all basepoints.

$$H_* (\mathcal{C}, \vec{\sigma}) \cong HF_{(+)1} \oplus HF_{(-)1} \cong \widehat{HF}(S^3) \otimes V.$$

Exercise: (Algebraic)

Show that Claim \Rightarrow $\widehat{HF}(\mathcal{C}, \vec{\sigma}, \beta, \vec{v}) \cong \widehat{HF}(Y) \otimes V^{n-1}$

Application

Grid diagram calculation for HFK (or HFL)

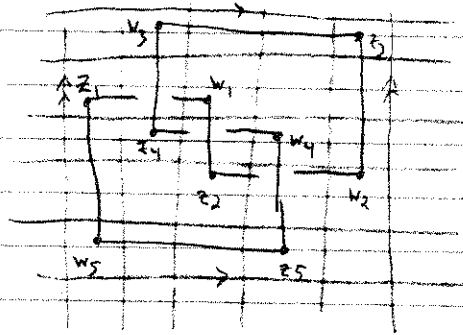

← Sutured Heegaard diagram for $(S^3 - K, \gamma_{10})$

↑
5 pairs of meridional sutures.

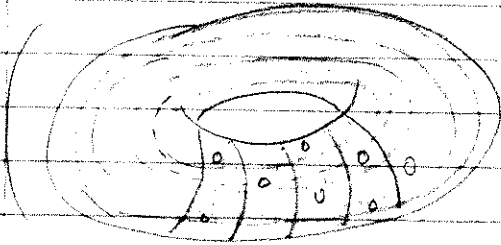

$$\times I \left(\bigcup_{i=1}^5 D_{\alpha_i} \cup \bigcup_{i=1}^5 D_{\beta_i} \right) \cong S^3 - \text{Trefoil}$$

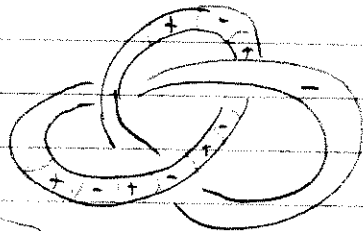

Don't miss all basepoints / sutures

Prop.

$$\widehat{CFK}(\text{Diagram}, \vec{\sigma}) = SFH(S^3 - K, \gamma_{10})$$

$\vec{\sigma} = \partial_{SFH}$ counts empty rectangles

!!! we know the differential

$$\widehat{CFK} = \bigoplus_{\sigma \in S_{\vec{\sigma}}} F\langle \sigma \rangle$$

← Symmetric group on $|\vec{\sigma}|$.

Pf. The only regions that in general homotopy are rectangles
(Recall: Discussion of nice diagrams from last semester.)

Back to SFH

Goal: Understand how SFH behaves under surface decompositions.

Roughly, A surface decomp. $(M, \gamma) \xrightarrow{S} (M', \gamma')$
 cuts (M, γ) along $\text{nbhd}(S)$ & obtains a new sutured mfd. (M', γ') .

More precisely, let S be a properly embedded ^{oriented} surface in (M, γ) $\partial \text{nbhd}(S) = \partial(S \times I)$
 $M' \cong M - \text{nbhd}(S)$, $\partial M' = (\partial M - \text{nbhd}(\partial S)) \cup \overbrace{S_+ \cup S_-}$

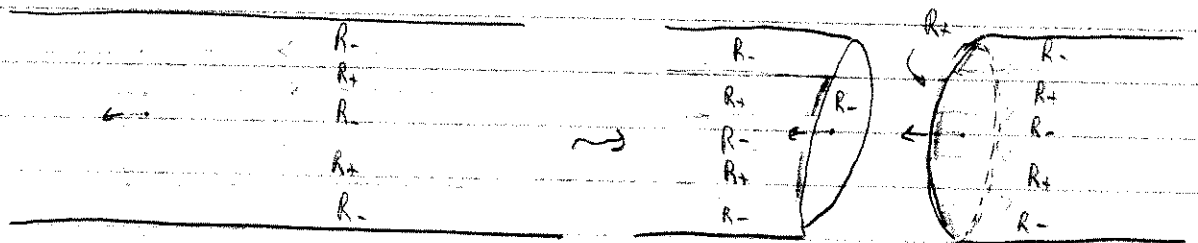

$\gamma' =$ Unique extension of $\gamma - \text{nbhd}(\partial S)$ to curves s.t.
 R_+' & R_-' don't meet.

Result: Product sutured manifolds are the simplest sutured manifolds.

Def. A sutured manifold hierarchy (for (M, γ)) is a finite sequence $(M_1, \gamma_1) \xrightarrow{S_1} (M_2, \gamma_2) \xrightarrow{S_2} (M_3, \gamma_3) \xrightarrow{S_3} \dots \xrightarrow{S_{n-1}} (M_n, \gamma_n)$
 s.t. (M_n, γ_n) is a product (i.e. $(R \times I, \partial R \times I)$).

Def. Given $(\overset{\text{connected}}{S}, \partial S) \hookrightarrow (M^3, \partial M)$, define $\chi_-(S) = \max \{0, -\chi(S)\}$.

Call this the complexity of S .

For S disconnected, $\chi_-(S) = \sum \chi_-(S_i)$ for $S = S_1 \cup S_2 \cup \dots \cup S_n$.

Def. Given $\alpha \in H_2(M, N)$, define $\Phi(\alpha) = \min \{ \chi_-(S) \mid (S, \partial) \hookrightarrow (M, N) \text{ s.t. } i_*(S, \partial) = \alpha \}$

Prop. (Thurston)

$\Phi: H_2(M, N) \rightarrow \mathbb{Z}^{\geq 0}$ extends in a unique way to

$\Phi: H_2(M, N; \mathbb{R}) \rightarrow \mathbb{R}^{\geq 0}$, a semi-norm.

(It is a norm if we don't have any $\alpha \in H_2(M, N)$ s.t. $\alpha \neq 0$
w/ $\Phi(\alpha) = 0$.)

e.g. if $N = \emptyset$, + $\alpha = [T^2] \neq 0 \in H_2(T^3 = M)$, then $\Phi(\alpha) = 0$.

Def. A balanced sutured manifold is taut if it is irreducible (i.e. every $S^2 \subset M$ bounds a ball) and R_+ (or R_-) are Thurston norm minimizing in $H_2(M, \partial)$.

i.e. $\Phi([R_+]) = \chi_-(R_+)$

Thm. If \exists a sutured manifold hierarchy for (M, γ) , then (M, γ) is taut.

Pf. (1) A product sutured manifold is taut.

~~Irreducibility implies $D^2 \cong \mathbb{R}^2$, so $\chi_-(D^2) = 0$.~~

~~Non-irreducible~~

~~$C \pm R \pm \text{ring disk arc } \times I$~~

(2) If $(M, \gamma) \xrightarrow{S} (M', \gamma') + (M', \gamma')$ is taut, then (M, γ) is taut.

Thm. (much harder) If (M, γ) is taut, then \exists a hierarchy.

Black-boxed.

Our goal, then, is to understand how $SFH(M, \gamma)$ changes under surface decomposition.

We should try to understand surface decomposition on the level of Heegaard diagrams.

"Products aren't interesting is the moral of Topology."

-Matt Hedden.

Recall: Proof of the Adjunction Inequality for HF^+ (closed 3-manifold).

Idea of that proof was (1) Given $\Sigma^2 \hookrightarrow Y$, we represent $\Sigma^2 - \{2 \text{ disks}\}$

as a periodic domain on a Heegaard surface representing Y .

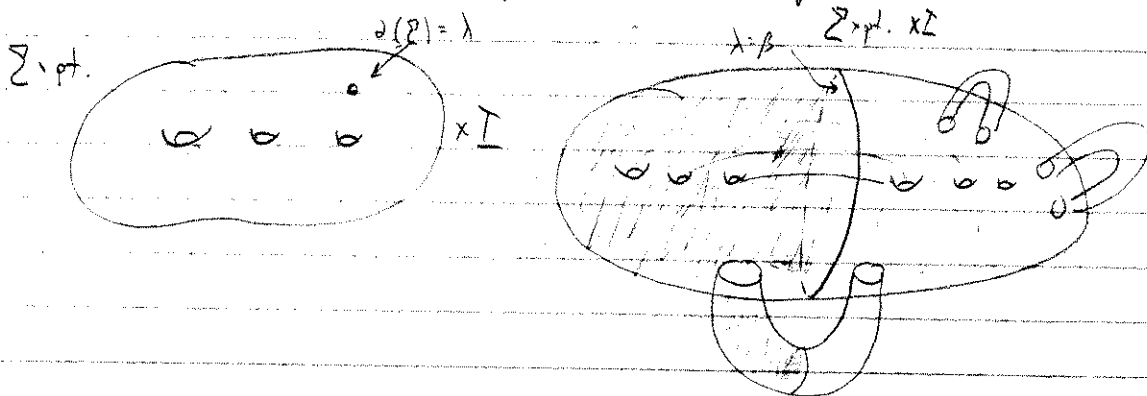

$$\langle c_1(s_w(\vec{x})), [P] \rangle = \chi(\Sigma - 2 \text{ pts.}) + 2n_{\vec{x}}(P)$$

$$\uparrow \qquad \qquad \qquad \parallel$$

$$[\Sigma] \qquad \qquad \qquad -2g(\Sigma)$$

In SFH, we want to see the decomposing surface on the Heegaard surface.

Def. A product disk is a properly embedded disk in (M, γ) intersecting γ in exactly two points.

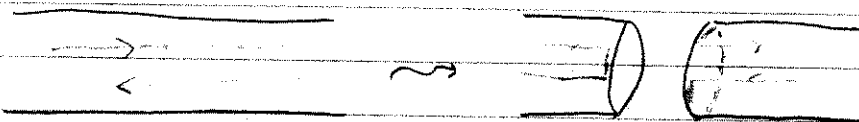

Lemma Let $(M, \gamma) \xrightarrow{S} (M', \gamma')$ be a product disk decomposition.

Then (M', γ') is a product $\Leftrightarrow (M, \gamma)$ is a product.

Thm. Let $(M, \gamma) \xrightarrow{S} (M', \gamma')$ be a product disk decomposition.

Then $SFH(M', \gamma') \cong SFH(M, \gamma)$.

Remark: If this weren't true, we'd be screwed if we wanted to show that SFH detects products.

Pf. Given $(D^2, \partial) \hookrightarrow (M, \mathcal{F})$, \exists a H.D. for (M, \mathcal{F}) st.

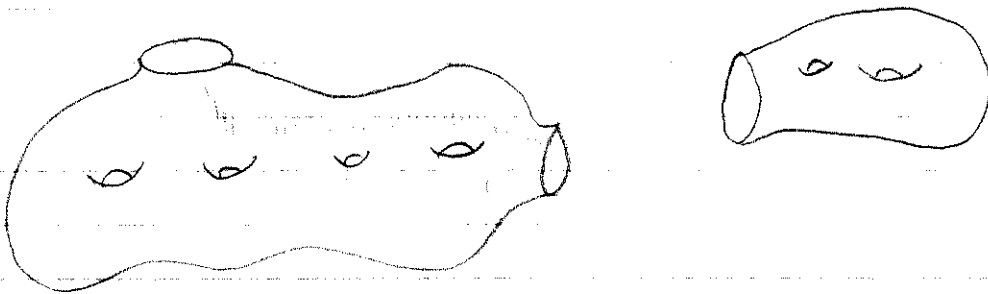

\exists bigon P with $\partial P = A \cup B$,
 $A \cap \vec{\beta} = \emptyset$
 $B \cap \vec{\alpha} = \emptyset$

and $D = P \cup (A \times [0, 1] \subseteq \Sigma \times I \cup D_\beta) \cup (B \times [-1, 0] \subseteq \Sigma \times I \cup D_\alpha)$

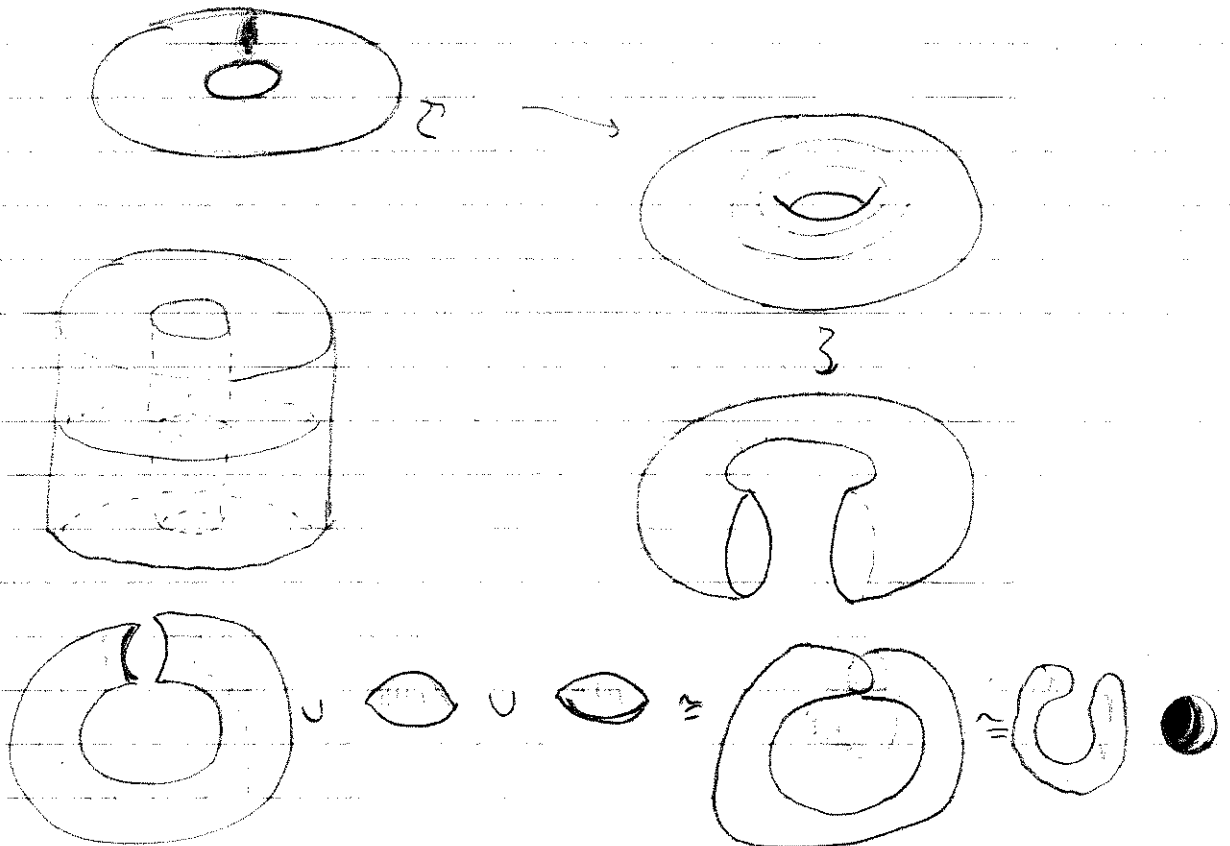

Now we prove:

Step 1. Given DSM, find H.D. where D arises as a diagonal in this way. \dagger

Step 2. Show that disk decomposition corresponds to H.D. decomposition.

Step 3. $\therefore \text{SFH}(\text{HD}^{\text{before}}) = \text{SFH}(\text{HD}^{\text{after}})$

$A + B$ are isotopic, so $A + B \cap (\bar{\alpha} \cup \bar{\beta}) = \emptyset$.

Thus, the generators of SFH are the same before and after.

Since the differential doesn't count any disks that are adjacent to the boundary, the differential doesn't change either.

Math Header H=H 4/26/11

Last time:

Def Sutured manifold (surface) decomp. $(M, \gamma) \xrightarrow{\Sigma} (M', \gamma')$.

Def Thurston seminorm on $H_2(M, \partial M)$

Def Taut sutured manifold. (M, γ) s.t. R_+ / R_- are Thurston norm-minimizing

Def Sutured manifold hierarchy
 $(M, \gamma) \xrightarrow{\Sigma_1} \dots \xrightarrow{\Sigma_n} (M_{n+1}, \gamma_{n+1})$

|||

$(R \times I, \partial R \times I)$

Thm. A If \exists sutured hierarchy for (M, γ) , then (M, γ) is taut

Thm. B If (M, γ) is taut, then \exists a hierarchy

Def. A product disk (PD) decomposition is



Lemmas. $(M, \gamma) \xrightarrow{P.D.} (M', \gamma')$

(M', γ') taut $\Leftrightarrow (M, \gamma)$ taut

product \Leftrightarrow product

See Juhász - Holomorphic disks + Sutured Mnflds. (AGT)

- Floer Homology + Surface Decomp. (GT)

Thm. (Juhász) $(M, \gamma) \xrightarrow{P.D.} (M', \gamma') \Rightarrow SFH(M, \gamma) = SFH(M', \gamma')$

PF. Adopted a H.D. for (M, γ) to the product disk

i.e. found a bigon in $(\Sigma, \tilde{\alpha}, \tilde{\beta})$ s.t.

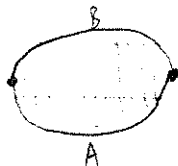

(1) Vertices $\subseteq \partial \Sigma$

(2) $A \cap \tilde{\beta} = \emptyset$

(3) $B \cap \tilde{\alpha} = \emptyset$

Argued that $(M, \gamma) \xrightarrow{P.D.} (M', \gamma')$

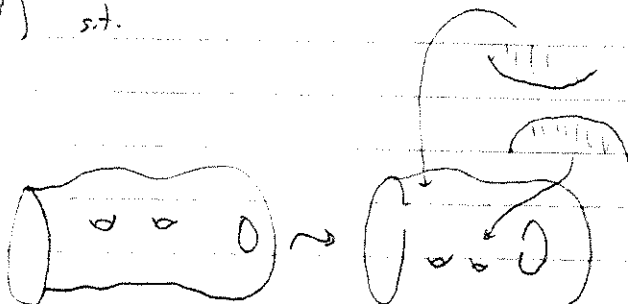

Def. A quasi-polygon is a surface P s.t. $\partial P = \text{union of circles}$.

decomposed into edges meeting along vertices.

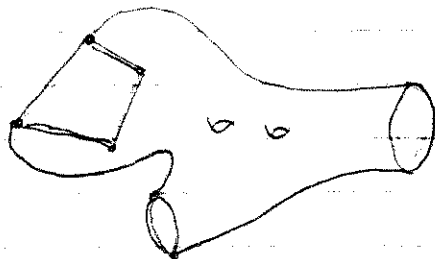

Lemma. Suppose (Σ, α, β) is a H.D. for (M, δ) + $P \subseteq \Sigma$ is a subsurface of Σ s.t.

- (1) P is a quasi-polygon with each component of ∂P having an even # of vertices alternatingly labeled $A + B$
- (2) Vertices of $\partial P = P \cap \partial \Sigma$.
- (3) $A \cap \beta = \emptyset$
- (4) $B \cap \alpha = \emptyset$.

Then, we can construct a decomposing surface $S(P) \subseteq (M, \delta)$ in a unique way (up to isotopy through decomposing surfaces)

Pf. (D₂ examples, essentially)

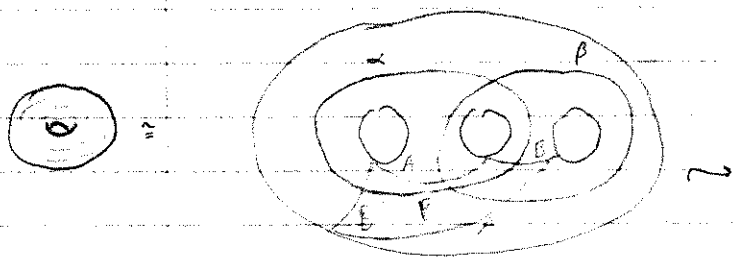

(Saddle surface)

The A -axis naturally flow down to the α -handle attachment side.

B -axis $\xrightarrow{\quad}$ up
 $\xrightarrow{\quad}$ β -handle $\xrightarrow{\quad}$

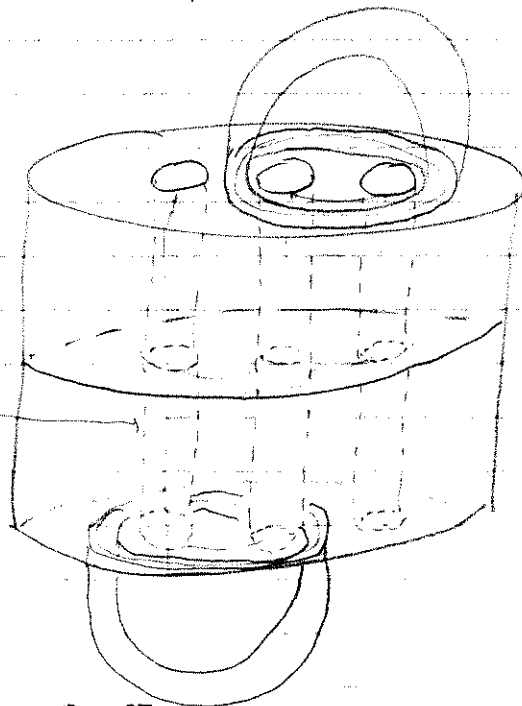

$$f: M \rightarrow [-1, 4]$$

$$f^{-1}(-1) = R_1$$

$$f^{-1}(4) = R_4$$

$$S(P) = P \cup_{A \times \{\frac{3}{2}\}} \left(A \times I \right) \cup_{B \times \{\frac{3}{2}\}} \left(B \times I \right)$$

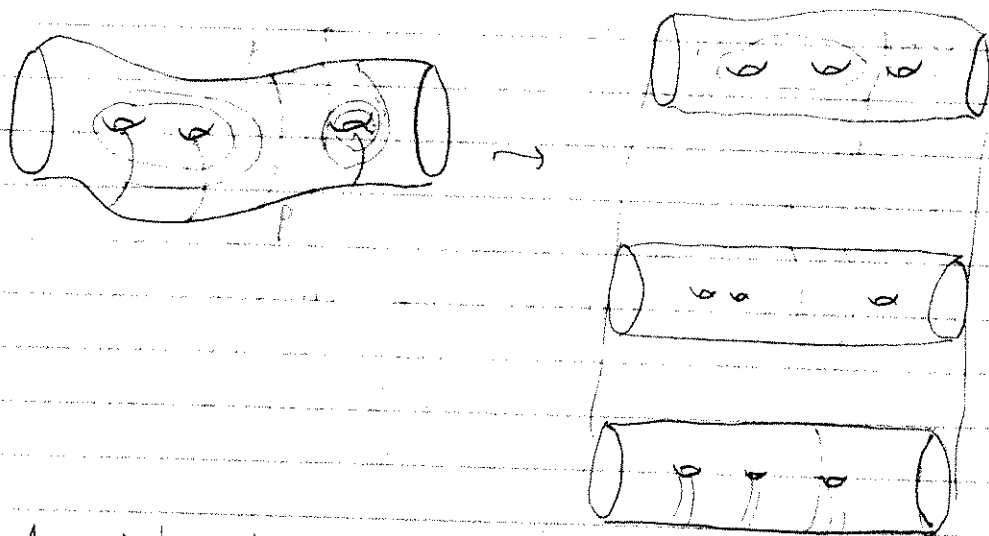

Def. A product annulus is a properly embedded annulus $A \subset (M, \mathcal{Y})$
 s.t. $S' \times \{-1\} \in \mathcal{R}_-$
 $S' \times \{1\} \in \mathcal{R}_+$.
 " $S' \times [-1, 1]$.

Note: The example above is a quasi-polygon whose associated surface $S(P)$ is a product annulus.

Thm. Let $(M, \mathcal{Y}) \xrightarrow{\text{Product Annulus}} (M', \mathcal{Y}')$ be a product annulus decomposition.
 Then $SFH(M, \mathcal{Y}) = SFH(M', \mathcal{Y}')$
 and (M, \mathcal{Y}) product $\Leftrightarrow (M', \mathcal{Y}')$ product.

PF. Exercise.

(Note: Product disks & annuli are special because in an annulus or a bigon in Σ , the two circles/arc of the boundary are isotopic.)

So $A \cap \beta = \emptyset \Rightarrow A \cap \tilde{\alpha} = \emptyset$ and $B \cap \tilde{\alpha} = \emptyset \Rightarrow B \cap \beta = \emptyset$
 \Rightarrow Chain complexes computing $SFH(M, \mathcal{Y})$ & $SFH(M', \mathcal{Y}')$ are identical.)

Def. A H.D. for (M, γ) is adapted to S if (M, γ) has a quasi-polygon P s.t. $S(P) \approx S$.

Lemma (A) "Any" decomposing surface has an adapted H.D.

(B) $(M, \gamma) \xrightarrow{S} (M', \gamma') \Rightarrow (M', \gamma')$ is associated to

$$\left(P_B \cup (\Sigma - P) \cup P_A =: \Sigma', \vec{\alpha}', \vec{\beta}' \right)$$

$\partial_B P \hookrightarrow \partial_B(\Sigma - P)$ $\partial_A P \hookrightarrow \partial_A(\Sigma - P)$

Not unrestrict conditions.

The surface should

intersect both R_0 & R_1 .

Probably one could

simply relax

the Def. of adapted H.D.

to allow any surface.

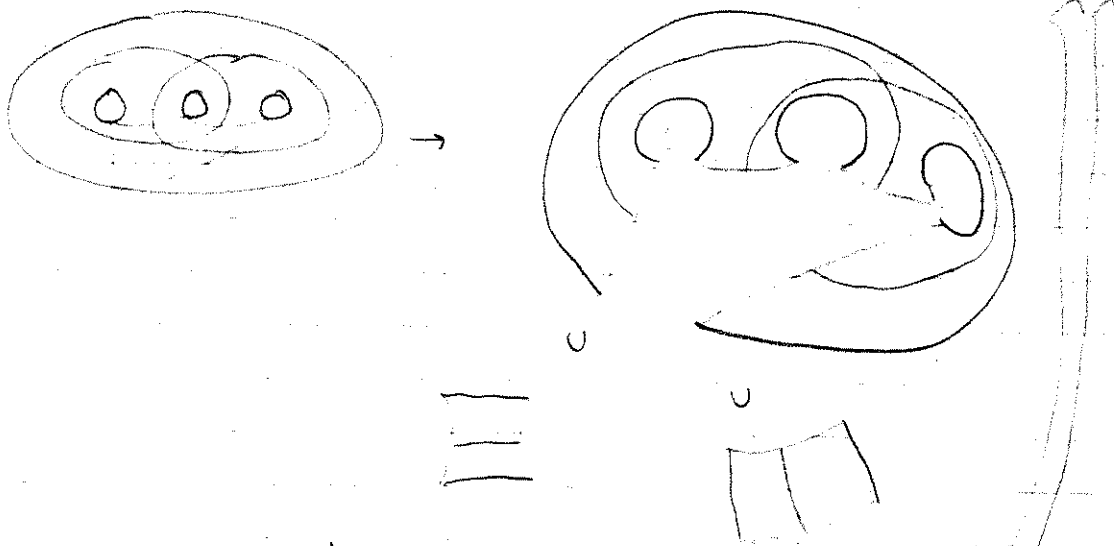

Where P has $\vec{\alpha} + \vec{\beta}$ arcs,

+ $\vec{\alpha}', \vec{\beta}'$ are forced (by desire) to form closed curves.

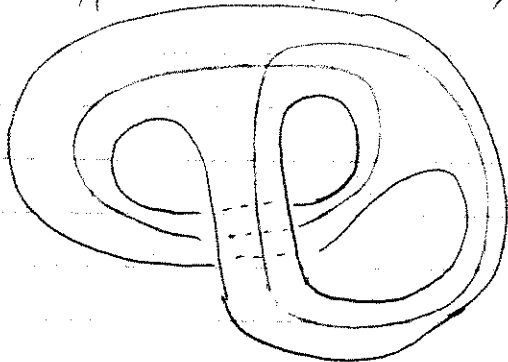

$$(\Sigma', \vec{\alpha}', \vec{\beta}')$$

Pf. (A) Construct function explicitly on $\partial M \cup \text{nbhd}(S)$ + extend to (M, γ) .

(B) Think about cut + paste def. of surface decomp. g and (M, γ) resp. (M', γ') .

Last Time:

Def. A H.D. adapted to a decomposing surface S
 "majority of S lies on Heegaard surface Σ , is a quasi-polygon, 'P'"

Def. $(\Sigma, \alpha, \beta; P) \xrightarrow{SEP} (\Sigma', \alpha', \beta')$ Decomposing H.D.

Lemma. Decomposed H.D. gives rise to $(M', \gamma') = (M, \gamma)$ decomposed along S .

Ex:

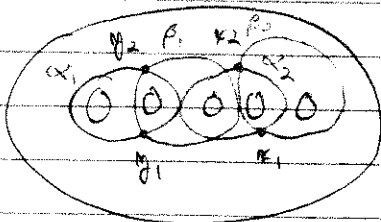
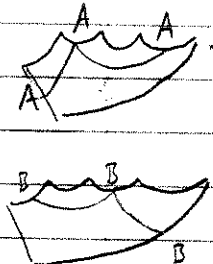
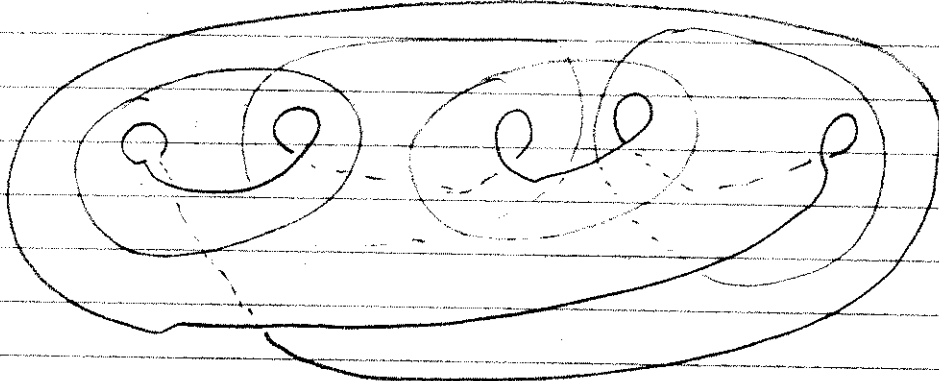
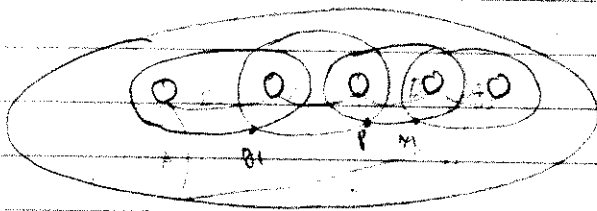

4 generators $\{\mu_i, \kappa_j\} \quad i, j \in \{1, 2\}$

Explicit computation shows

$$E(\{\mu_i, \kappa_j, \mu_l, \kappa_m\}) \neq 0 \text{ unless } i=l, j=m$$

Note: $H_1(M; \mathbb{Z}) \cong \mathbb{Z}^4$
 $E(\mathbb{F}, \mathbb{F})$

$$\Rightarrow SFH(M, \gamma) \cong \mathbb{F}^4$$

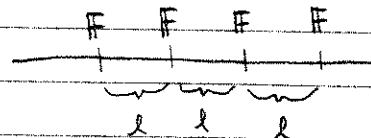

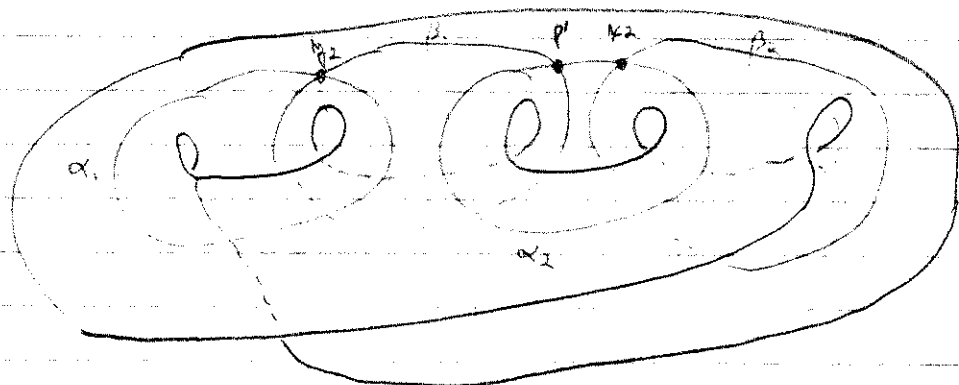

Note: When we decompose the H.D., we lose any $\vec{x} \in \Pi_0 \cap \Pi_P$ that has a component $\lambda_{x_i} \in \vec{x}$ lying in P .

In this example, $SFH(M', \gamma') = \langle \{ \alpha_1, \gamma_2 \} \rangle$

This example naturally generalizes to yield a map of groups

$$C(\Sigma', \alpha', \beta') \xrightarrow{i_P} C(\Sigma, \alpha, \beta, P)$$

Goal: See that the map i_P is a chain map, and moreover, is an inclusion on homology.

$$\text{i.e. } SFH(M', \gamma') \hookrightarrow SFH(M, \gamma)$$

We need a more intrinsic splitting of $SFH(M, \gamma)$ than simply \mathbb{Z} -classes. We will use relative Spin^c -structures.

Def. A relative Spin^c -structure on a sutured manifold is a homology

class of n.v.v.f. agreeing with v_{fix} on ∂M ,

where $v_{\text{fix}} := \begin{cases} \text{inward normal on } R_- \\ \frac{\partial}{\partial t} \text{ on annulus } \gamma \times [-1, 1], \text{ nbhd (sutures)} \\ \text{outward normal on } R_+ \end{cases}$

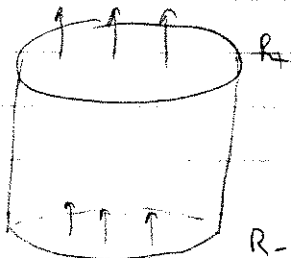

Lemma. Let $\underline{s}, \underline{t} \in \text{Spin}^c(M, \gamma)$. Then, \exists a well-defined difference

$$\underline{s} - \underline{t} \in H^2(M, dM; \mathbb{Z})$$

Further, given $\vec{x} \in \Pi_\alpha \cap \Pi_\beta$, \exists map $\vec{x} \mapsto \underline{s}(\vec{x}) \in \text{Spin}^c(M, \gamma)$.

(Pf. Modif. $-\nabla f$ for a Morse function, as usual.)

And, $\underline{s}(\vec{x}) - \underline{s}(\vec{y}) = \text{PD}[\Sigma(\vec{x}, \vec{y})]$.

Def. Call an $\vec{x} \in \Pi_\alpha \cap \Pi_\beta$ outer wrt P if $x_i \notin P \ \forall i=1, \dots, k=|K|=|\beta|$.

Generators for $(\Sigma', \vec{\alpha}', \vec{\beta}')$ \leftrightarrow outer generators for $(\Sigma, \vec{\alpha}, \vec{\beta}, P)$.

$$C(\text{outer}) = \bigoplus_{\vec{x} \in \text{outer}} \mathbb{F}\langle \vec{x} \rangle, d$$

Claim. Outer generators generate a direct summand of $C(\Sigma, \vec{\alpha}, \vec{\beta})$.

Pf. It suffices to show that $\forall c \in C(\text{outer})$,

$$dc \subseteq C(\text{outer}) \text{ and}$$

~~$$\forall c \in C(\Sigma, \vec{\alpha}, \vec{\beta}), \quad dc \subseteq C(\Sigma, \vec{\alpha}, \vec{\beta})$$~~

This

$$\forall c \in C(\text{inner}), \quad dc \subseteq C(\text{inner}).$$

It would be E.T.S.

$$\Sigma(\vec{x}, \vec{y}) \neq 0 \quad \forall \vec{x} \in \text{inner}, \vec{y} \in \text{outer}.$$

Pick $\vec{x}_{\text{inner}} \in \text{inner}, \vec{y}_{\text{outer}} \in \text{outer}$.

A representative for $\# \Sigma(\vec{x}_{\text{inner}}, \vec{y}_{\text{outer}}) \cap P \neq \emptyset$, which implies

$$\Sigma(\vec{x}_{\text{inner}}, \vec{y}_{\text{outer}}) \neq 0 \in H^2(M, \gamma).$$

To see this, we can construct a representative for $\Sigma(\vec{x}, \vec{y})$ by arcs

$$\left. \begin{array}{l} \tau_\alpha \vec{x} \xrightarrow{\text{along } \alpha} \vec{y} \\ \cup \tau_\beta \vec{y} \xrightarrow{\text{along } \beta} \vec{x} \end{array} \right\} \tau_\alpha, \tau_\beta \text{ are pushed slightly into their respective handlebodies.}$$

But $(\tau_\alpha \cup \tau_\beta) \cap P$ exactly at $x_i \in x_{\text{inner}}$ lying in P .

Now we're done, since the orientation of $\tau_\alpha \cup \tau_\beta$ at $x_i \in x_{\text{inner}}$ is always the same (either up or down)

$$\# \Sigma(\vec{x}_{\text{inner}}, \vec{y}_{\text{outer}}) \cap P \neq 0$$

We've shown that

$$C(\text{outer}) \cong C(\Sigma', \alpha', \beta')$$

$\cong \leftarrow \text{previous}$

Direct summand

$$\oplus (C(\text{outer}), \partial) \triangleleft C(\Sigma, \alpha, \beta)$$

Need to see that

$$\partial \Sigma = \partial \Sigma'$$

← Differential on $C(\Sigma', \alpha', \beta')$.
Differential on $C(\text{outer})$

Juhász' proof that $\partial \Sigma = \partial \Sigma'$

goes by way of "nice" diagrams
independent of $\partial \Sigma$

i.e. H.D. where all regions of $\Sigma - \{\alpha \cup \beta\}$ are bigons or rectangles.

When a H.D. is nice, the differential only counts $\phi \in \pi_2(\Sigma, \gamma)$ whose domains are embedded bigons or rectangles (which contribute ± 1 by RMT.)

Juhász refines the Sorkin-Wang algorithm to find a nice diagram so that

(A) $(\Sigma, \alpha, \beta, P)$ is nice

(B) $(\Sigma', \alpha', \beta')$ is nice

Then, observes that \exists bijection between domains $\phi \in \pi_2(\Sigma, \gamma)$ $\Sigma, \gamma \in \text{outer}$

and $\phi' \in \pi_2(\Sigma', \gamma')$ $\Sigma', \gamma' \in \Pi_{\Sigma'} \cap \Pi_P$

$$K \cong Y$$

Thm. $g(K) = \max \{i \mid \widehat{\text{HFK}}(K, i) \neq 0\}$

PF. Let F be a min. genus Seifert surface for K

$$(Y\text{-nbd.}(K), \gamma_2) \xrightarrow{\text{meridians}} (Y-F, \partial F) \xrightarrow{\text{Gibbs hierarchy}} (R \times I, \partial R \times I)$$

$$\oplus_{i \in \mathbb{Z}} \text{SFH}(i, S) = \widehat{\text{HFK}}(Y, K) \xrightarrow{\text{By previous Thm.}} \text{SFH}(Y-F, \partial F) \xleftrightarrow{\cong} \text{SFH}(R \times I, \partial R \times I)$$

$\cong \leftarrow \text{By previous Thm.}$

By previous Thm, the inclusion $(i_F)_*$ maps into $C(\text{outer}) \cong \widehat{\text{HFK}}(Y, K, \gamma(F))$

This non-vanishing + Adjunction Inequality yields the Thm. \square
(i.e. $\widehat{\text{HFK}}(Y, K, i) = 0$ if $i > g(K)$)

Alexander grading

$$\frac{1}{2} \langle C_i(\Sigma), [F, \partial] \rangle \in \mathbb{D}([K], [F, \partial])$$