

NEGATIVE DEFINITE PLUMBING GRAPHS FOR BRIESKORN SPHERES

ABSTRACT. We provide a list of negative definite plumbing graphs and show which Brieskorn homology spheres they represent.

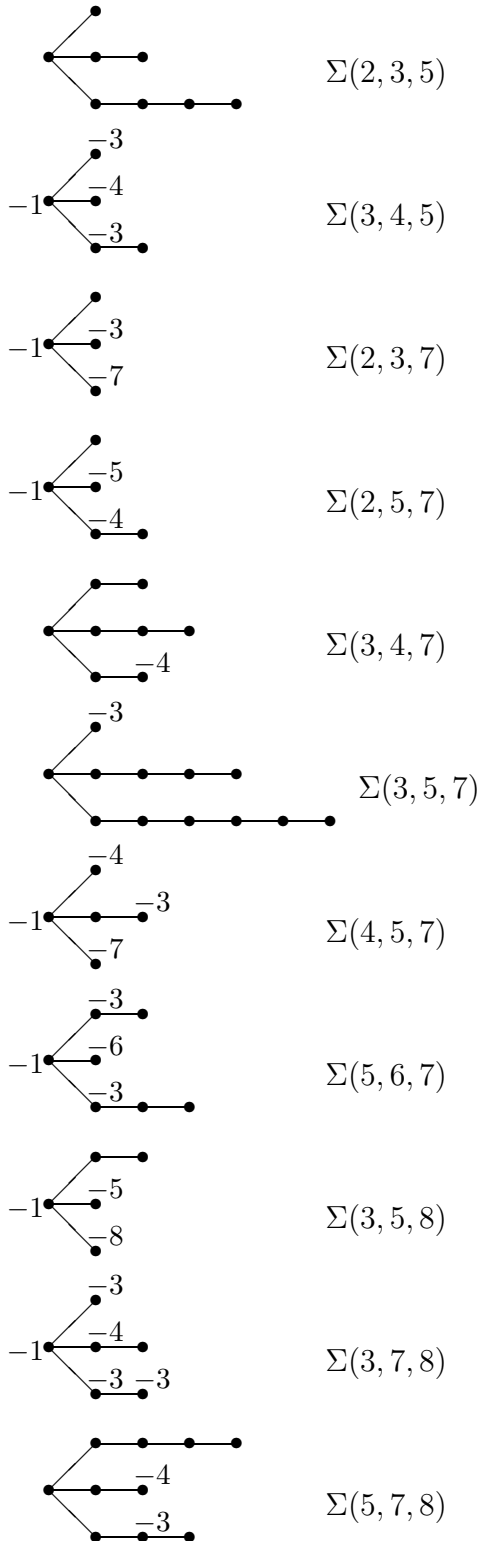

The algorithm stems from [vR] and stated in W.D. Neumann [NR], implementation by Selahi Durusoy, April 18, 2004.

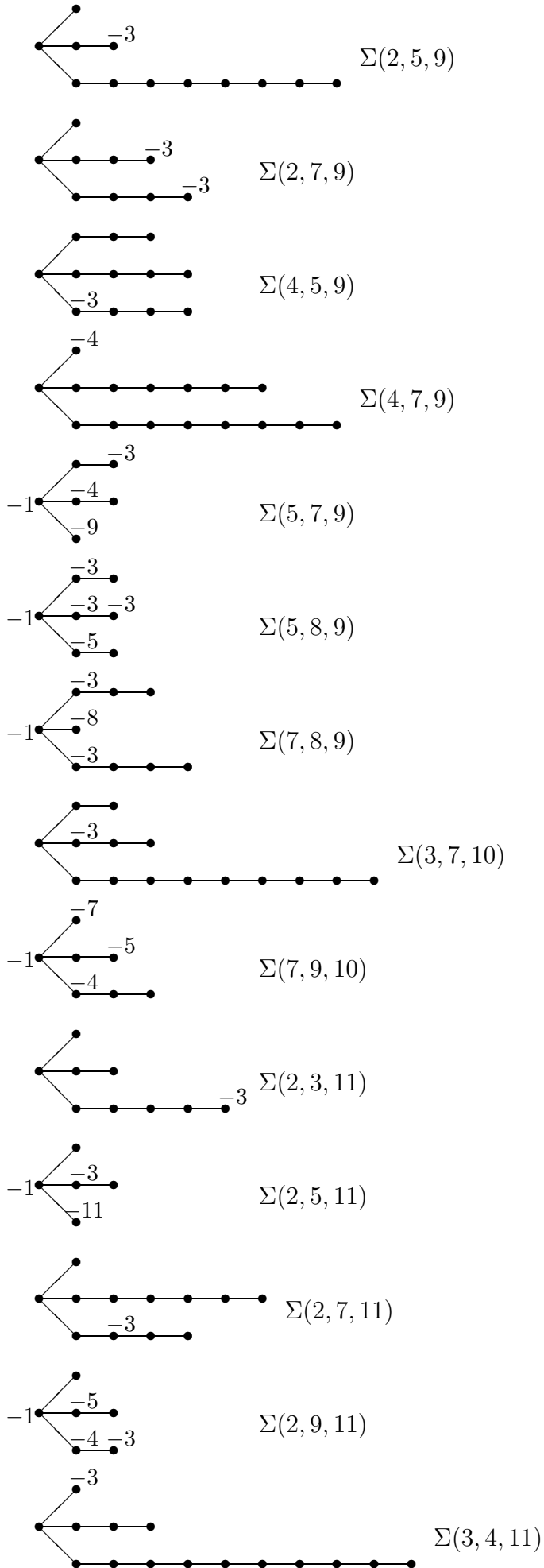

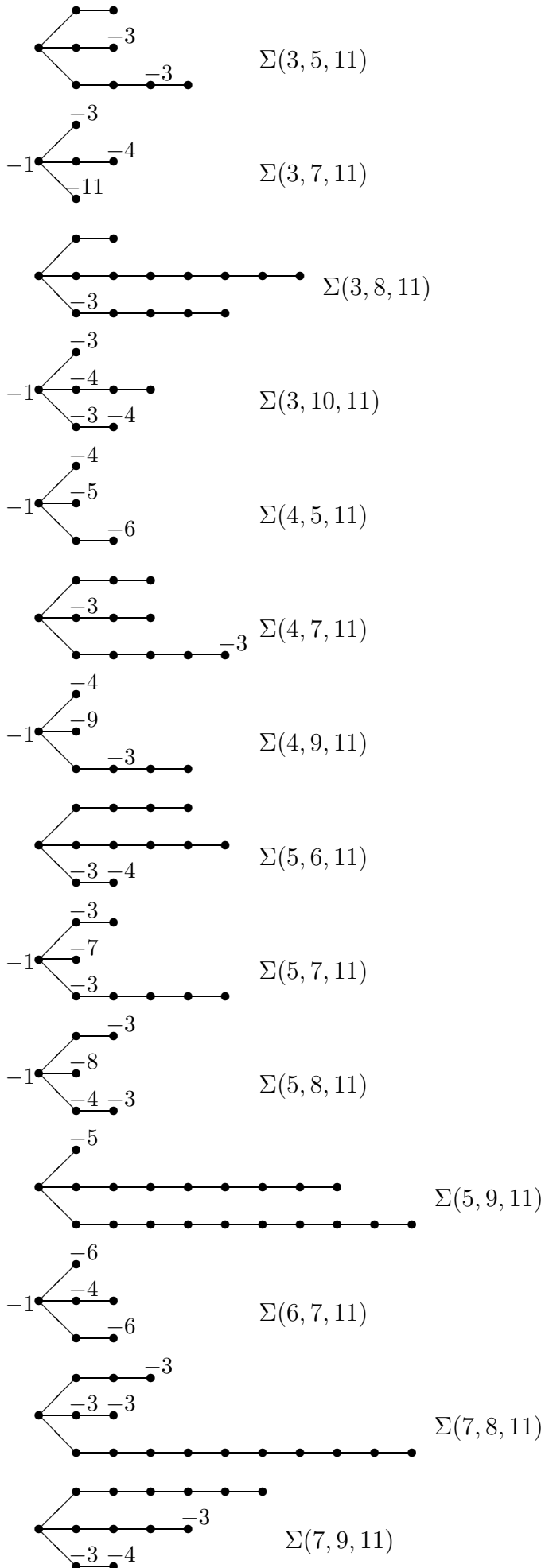

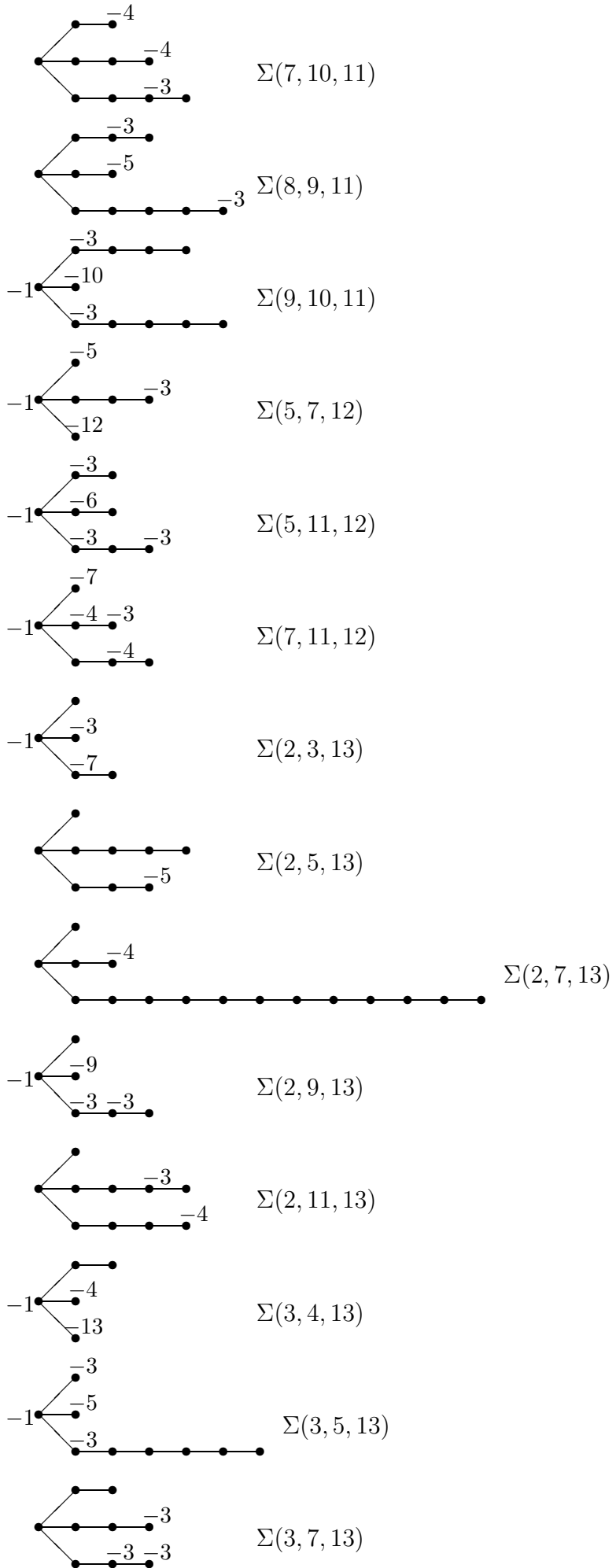

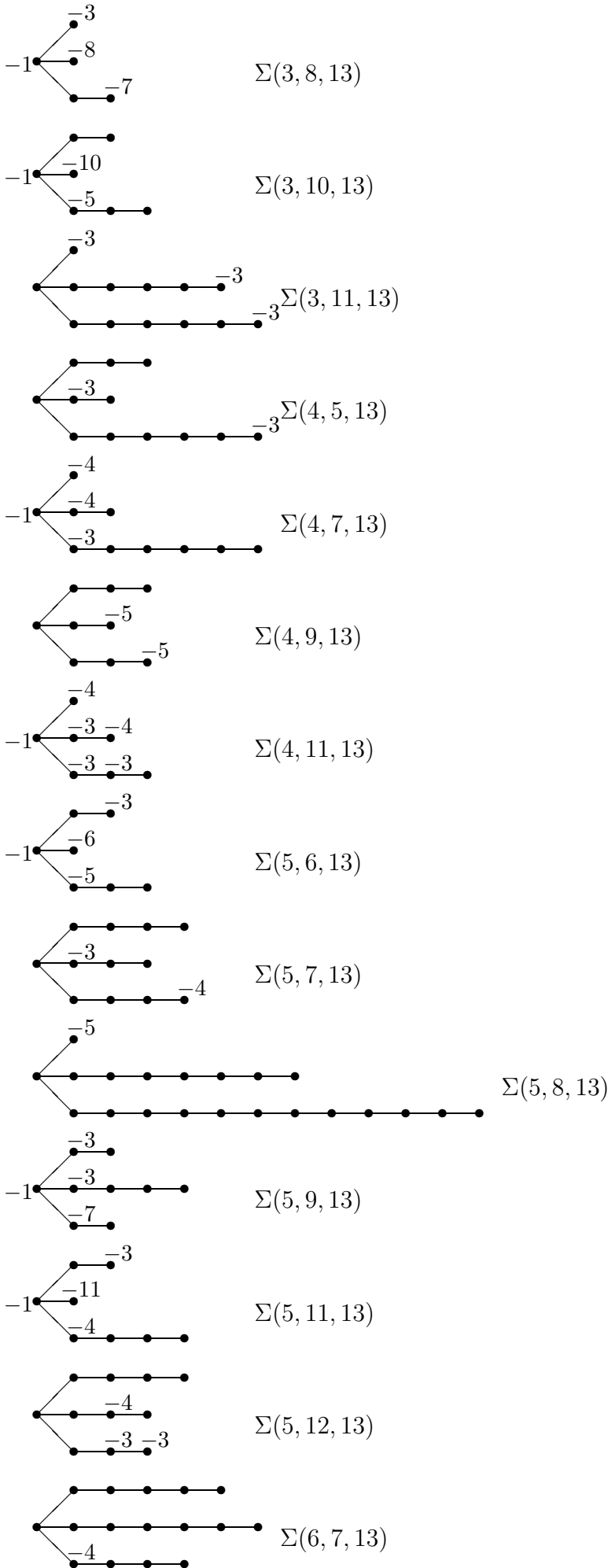

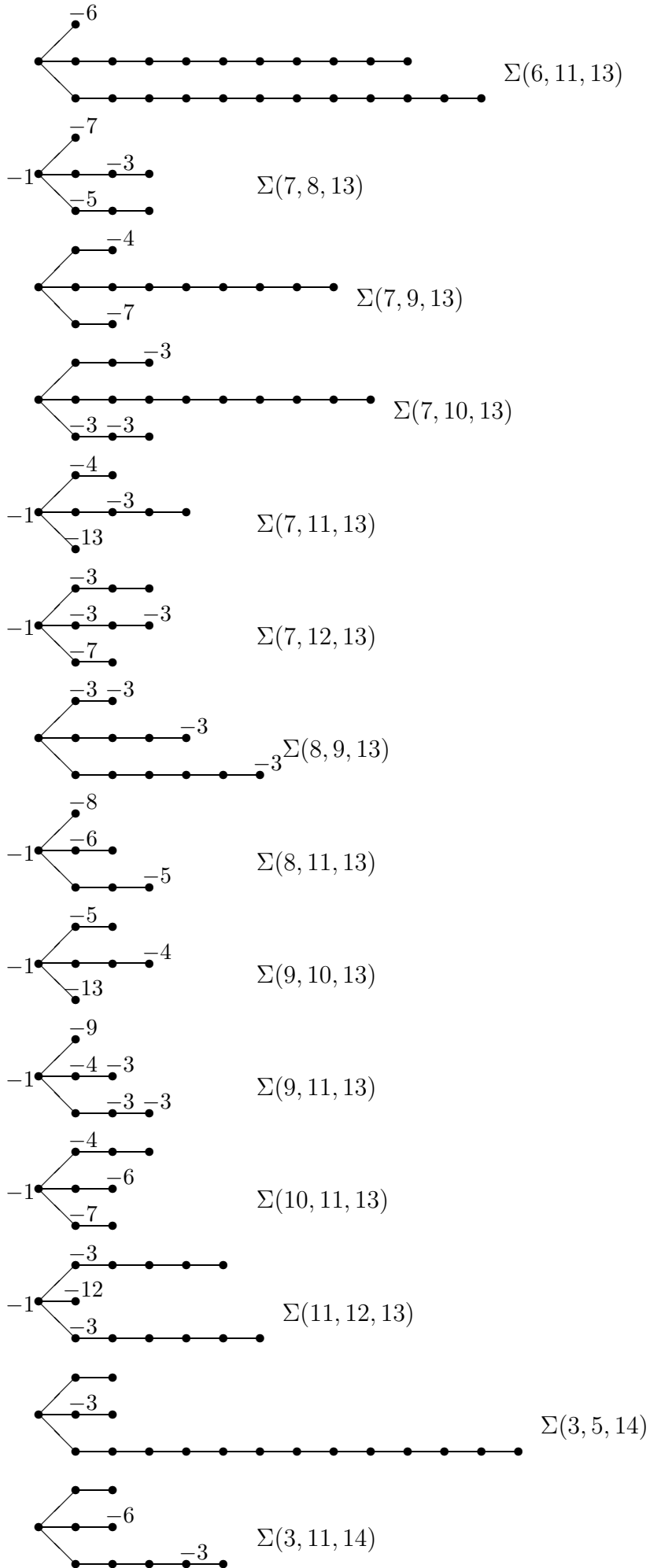

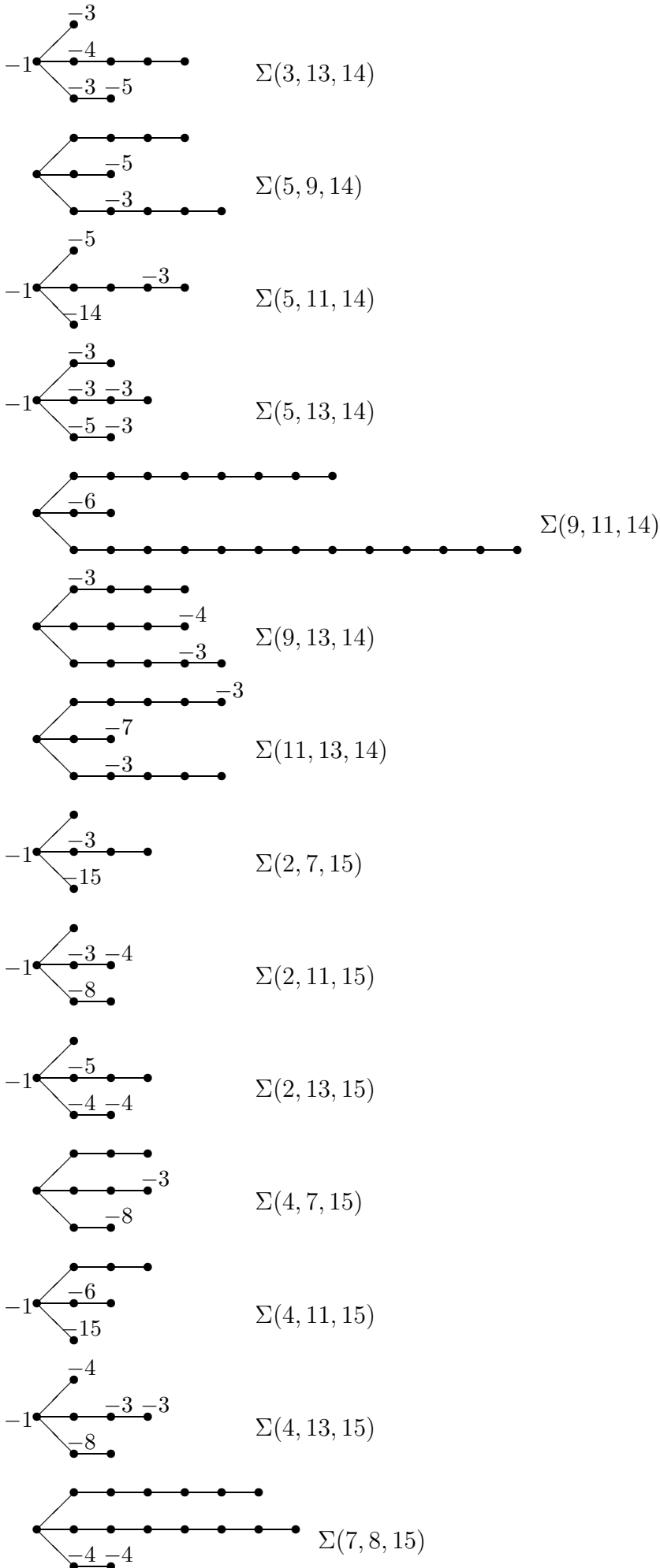

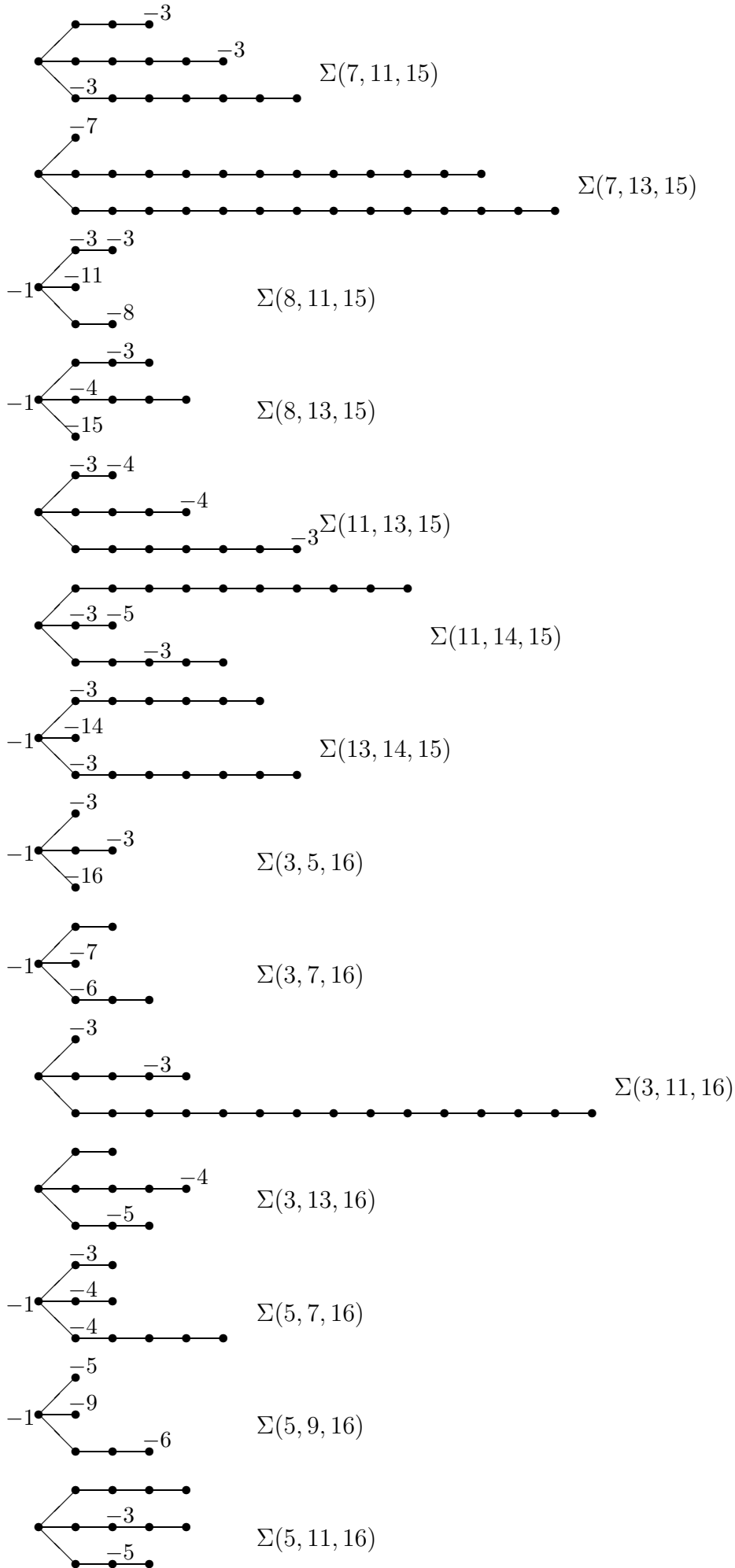

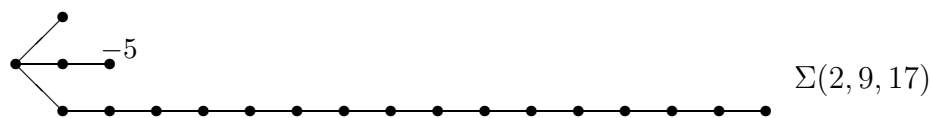
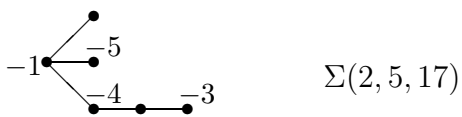
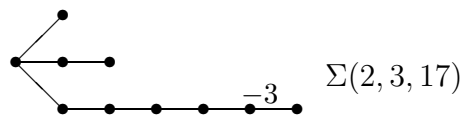
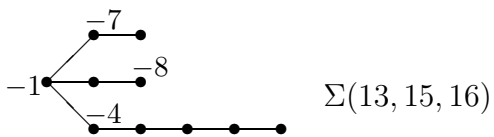
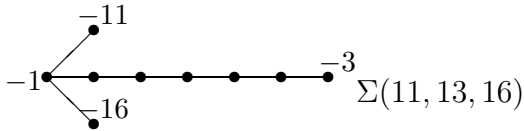
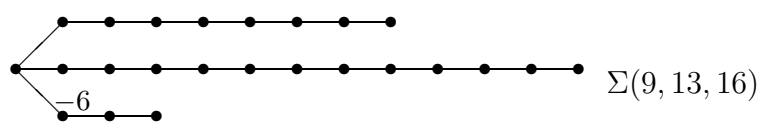
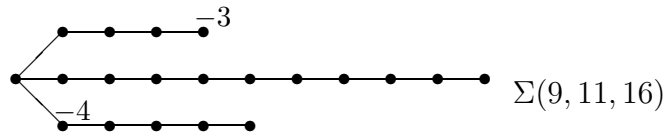
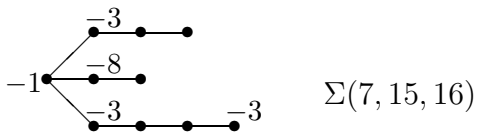
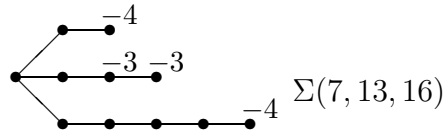
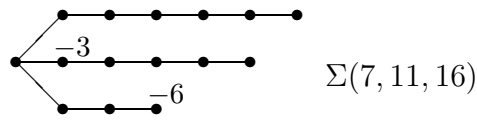
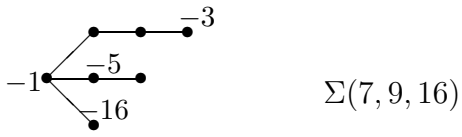
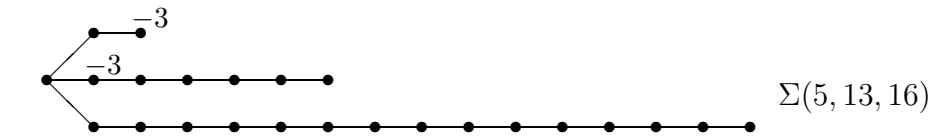

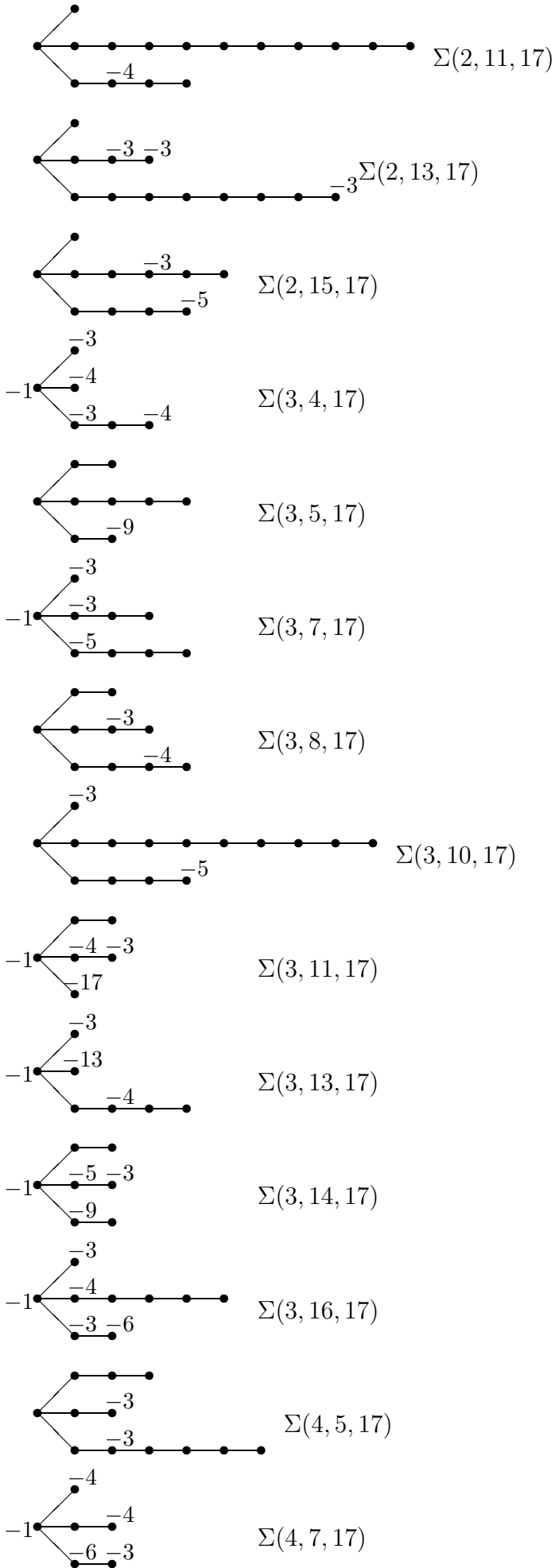

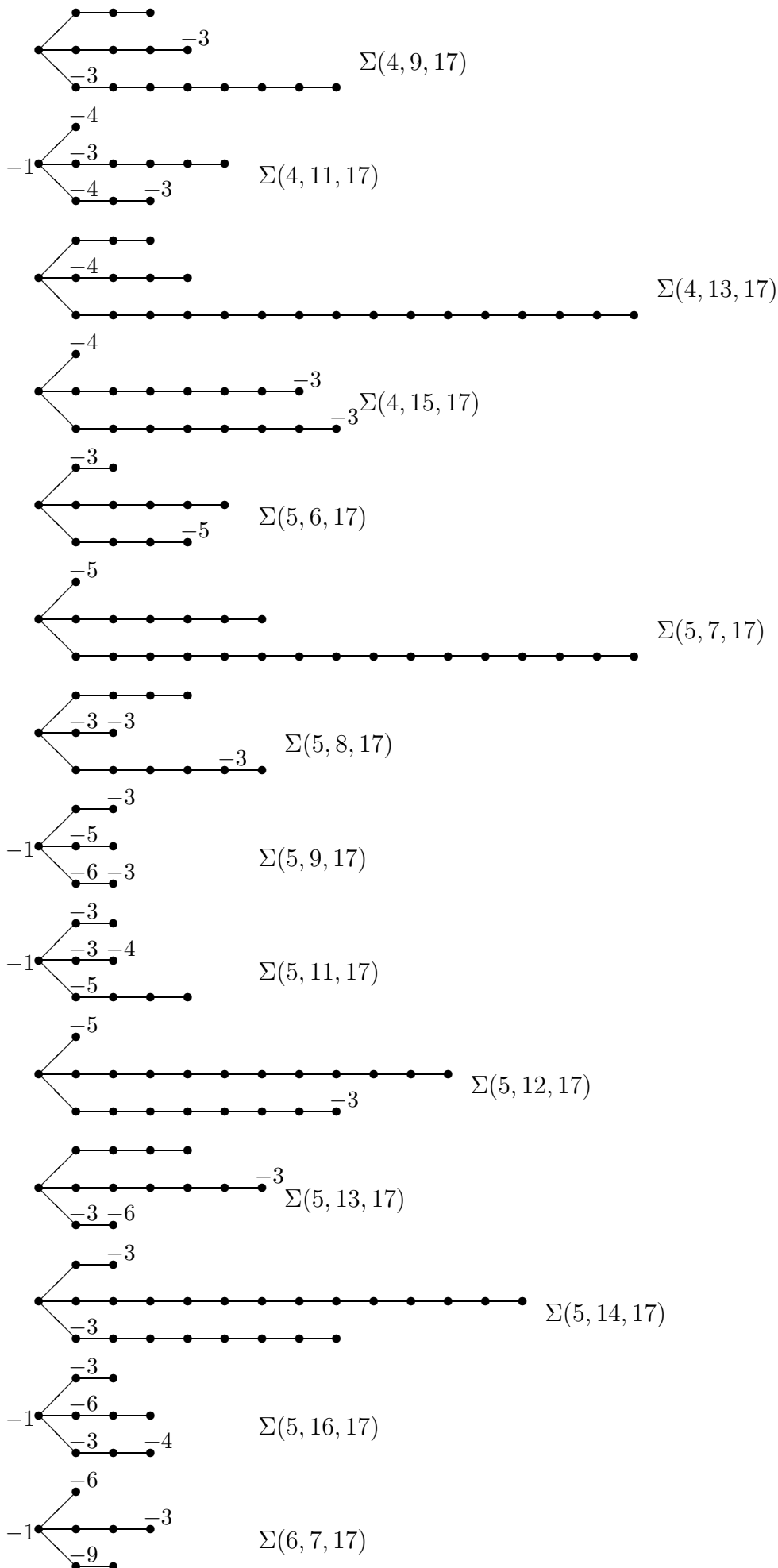

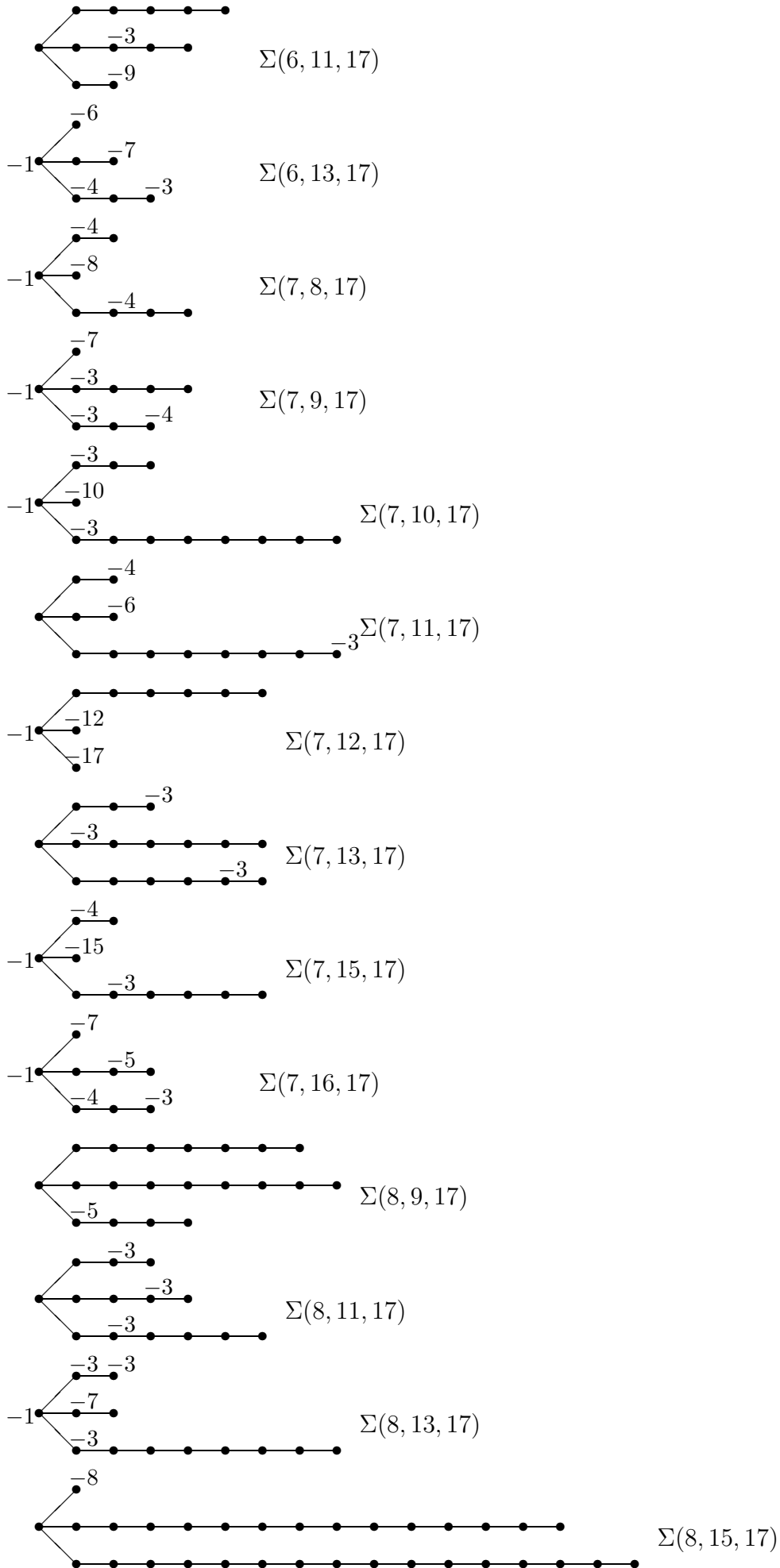

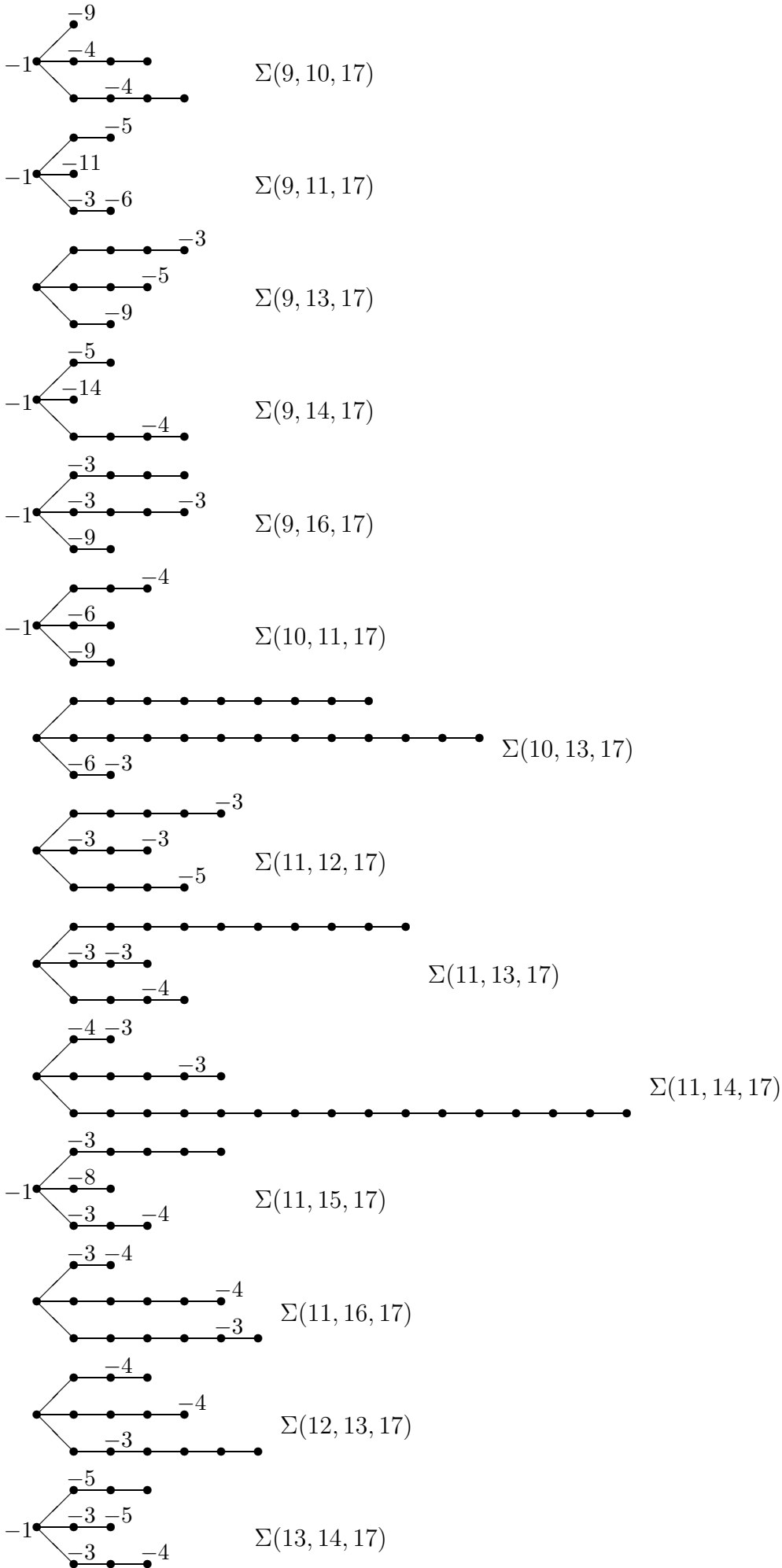

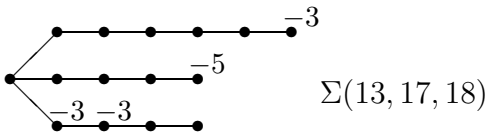
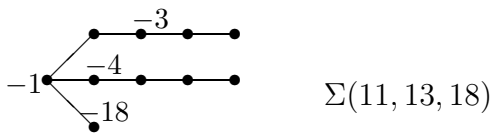
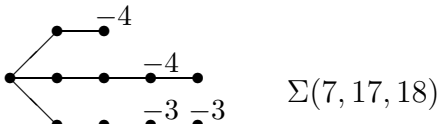
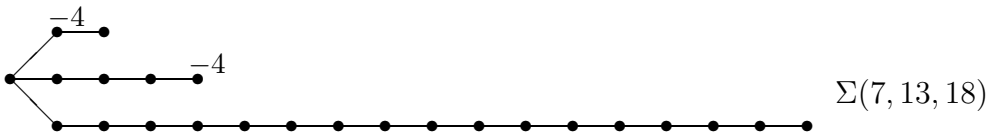
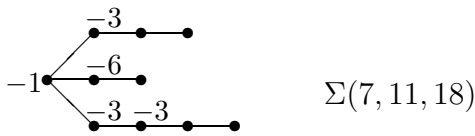
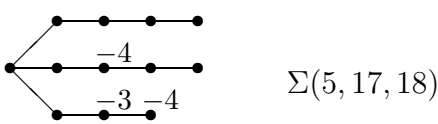
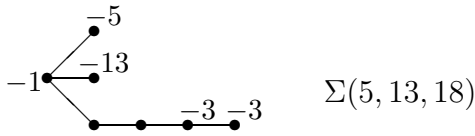
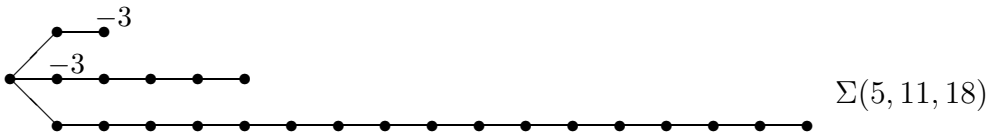
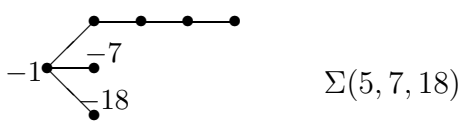
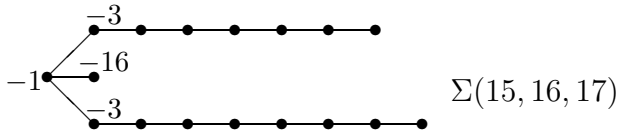
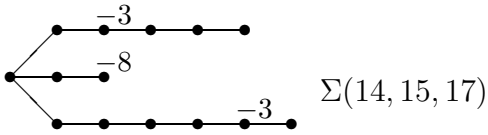
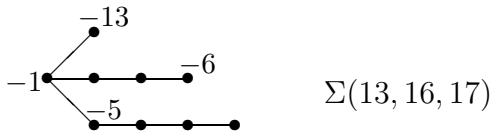
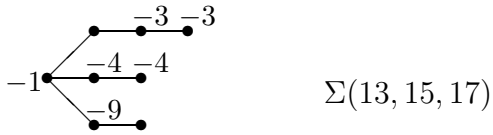

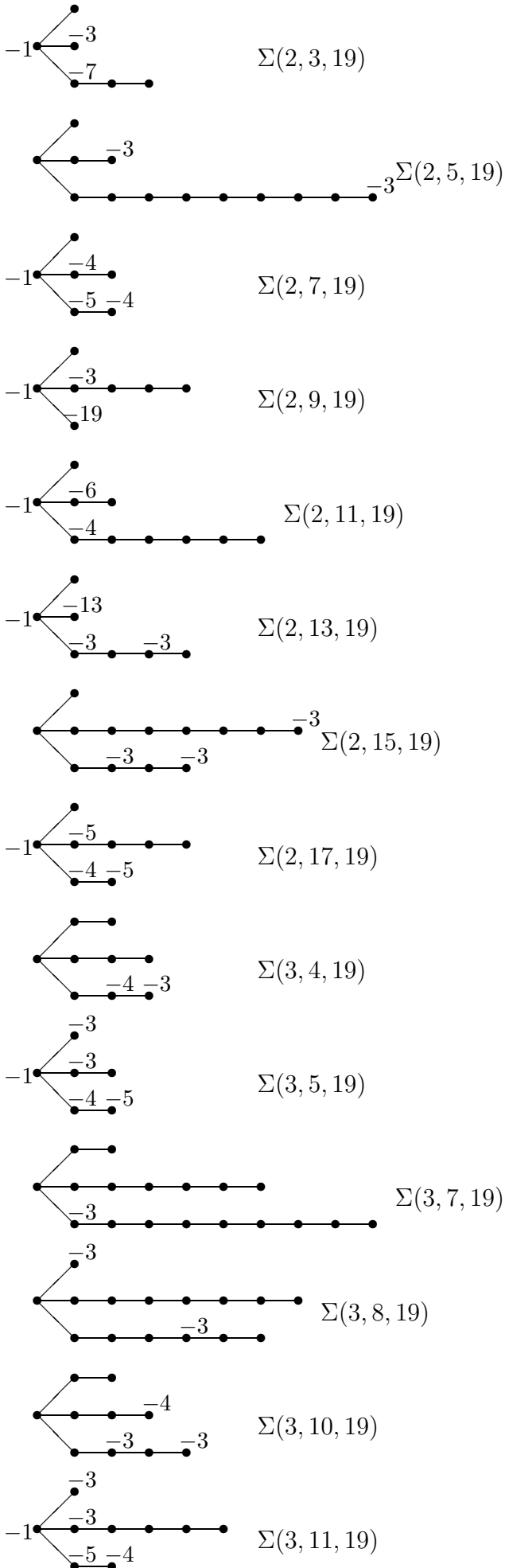

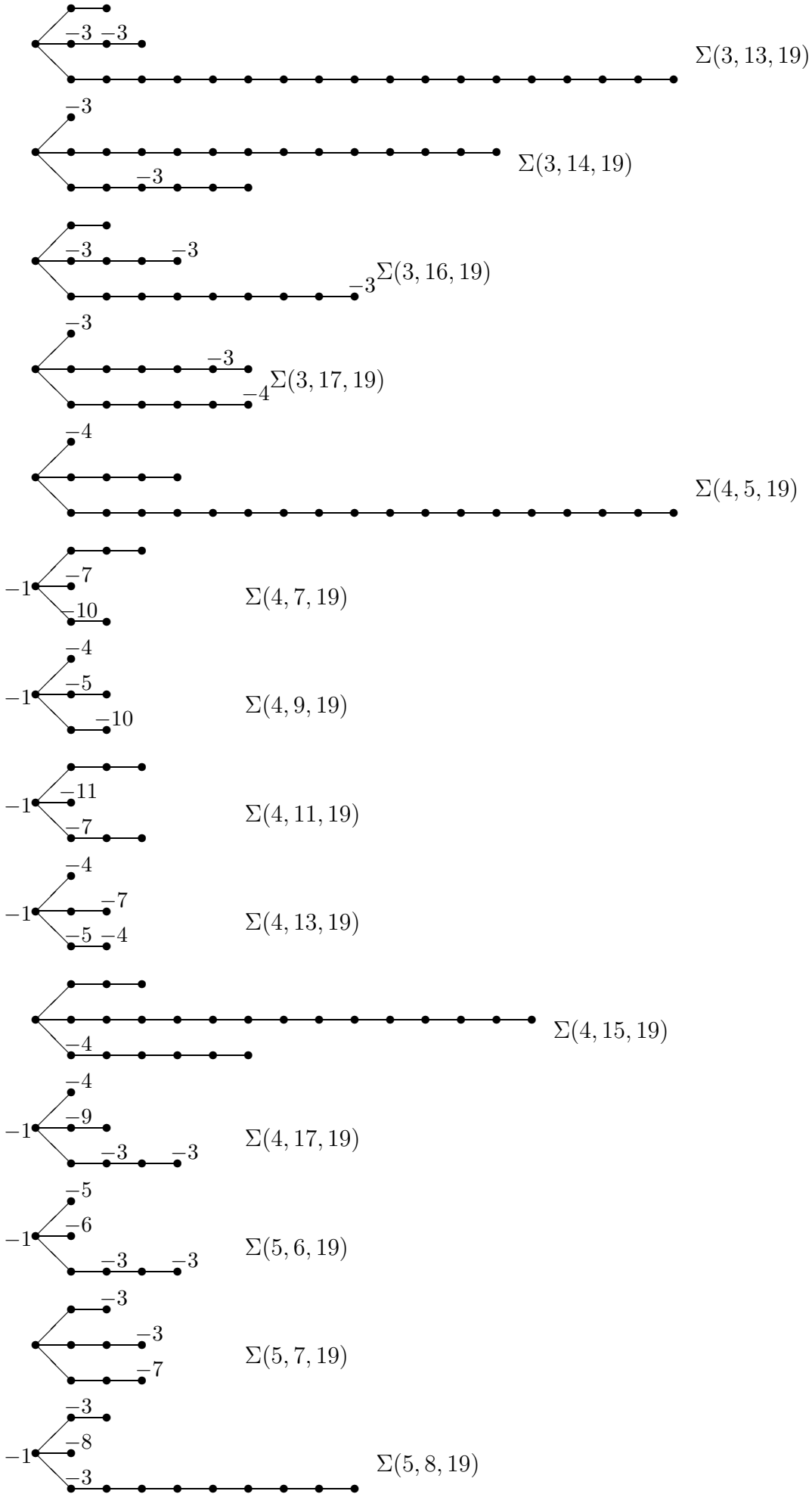

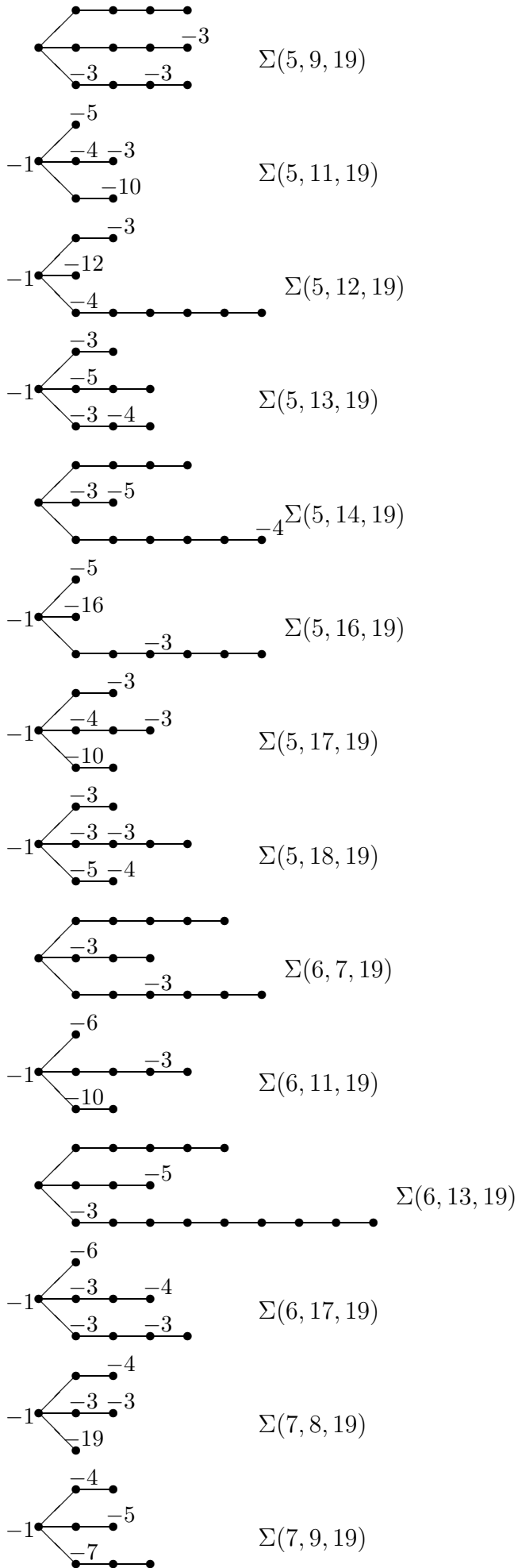

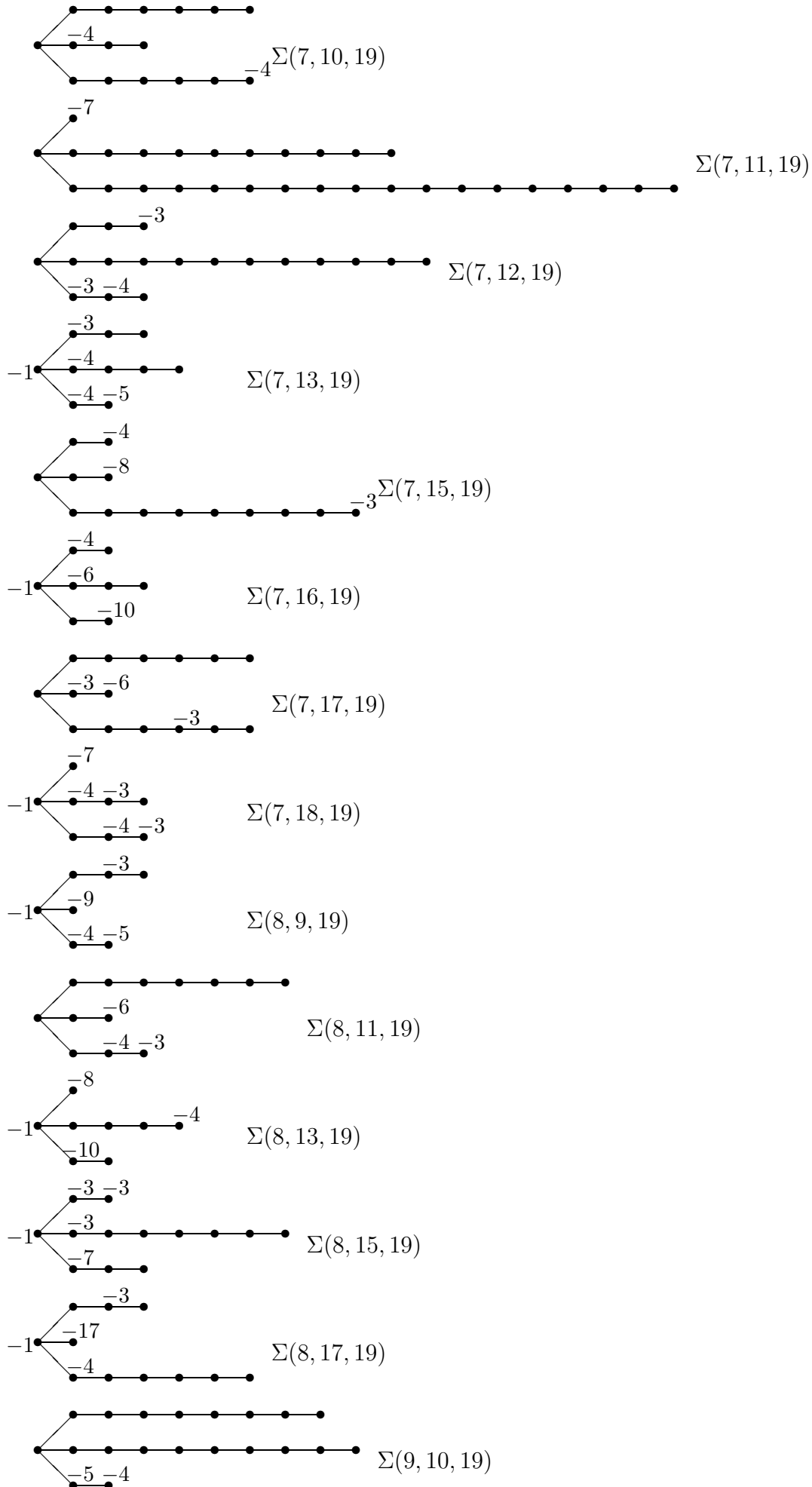

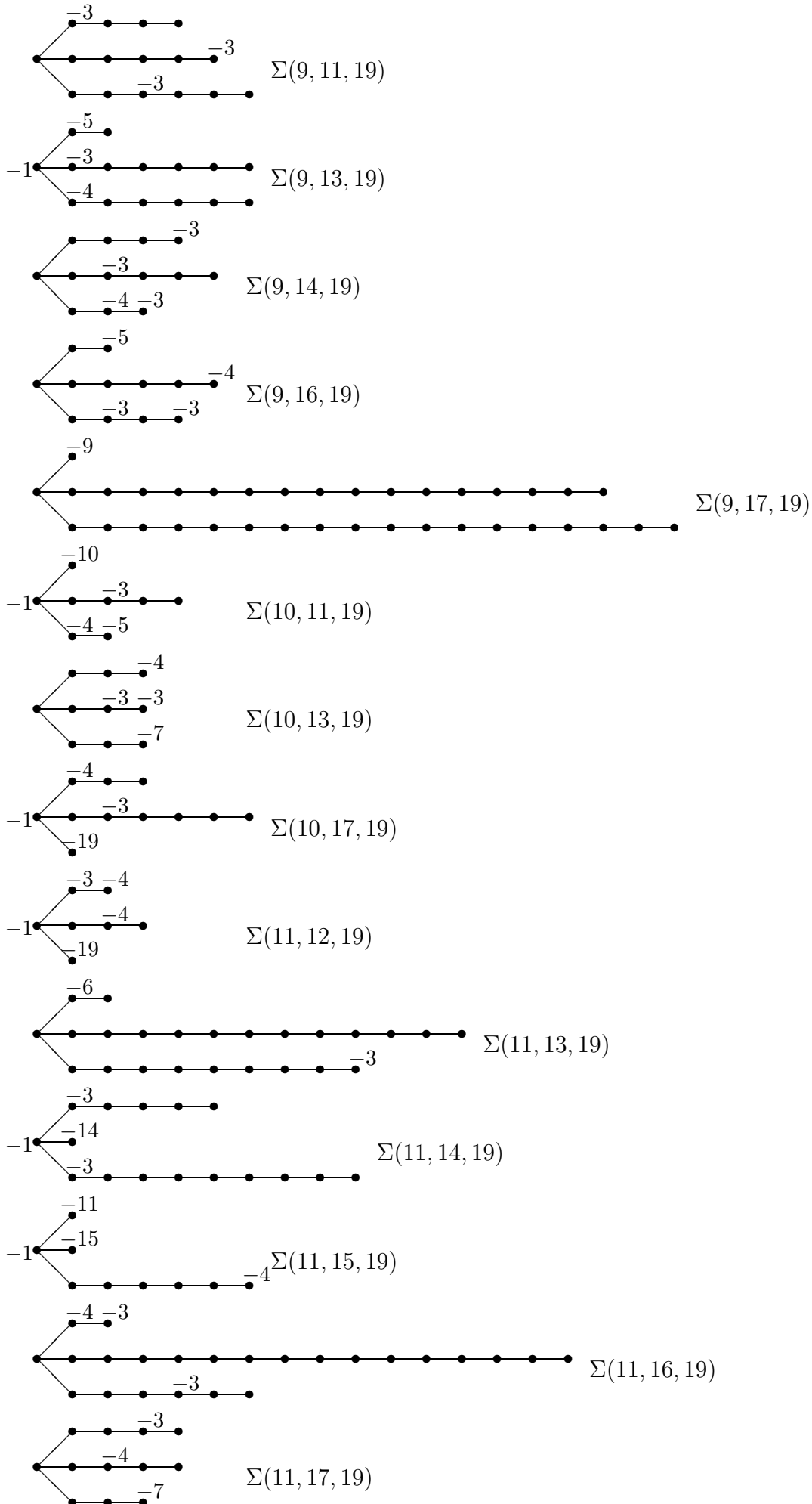

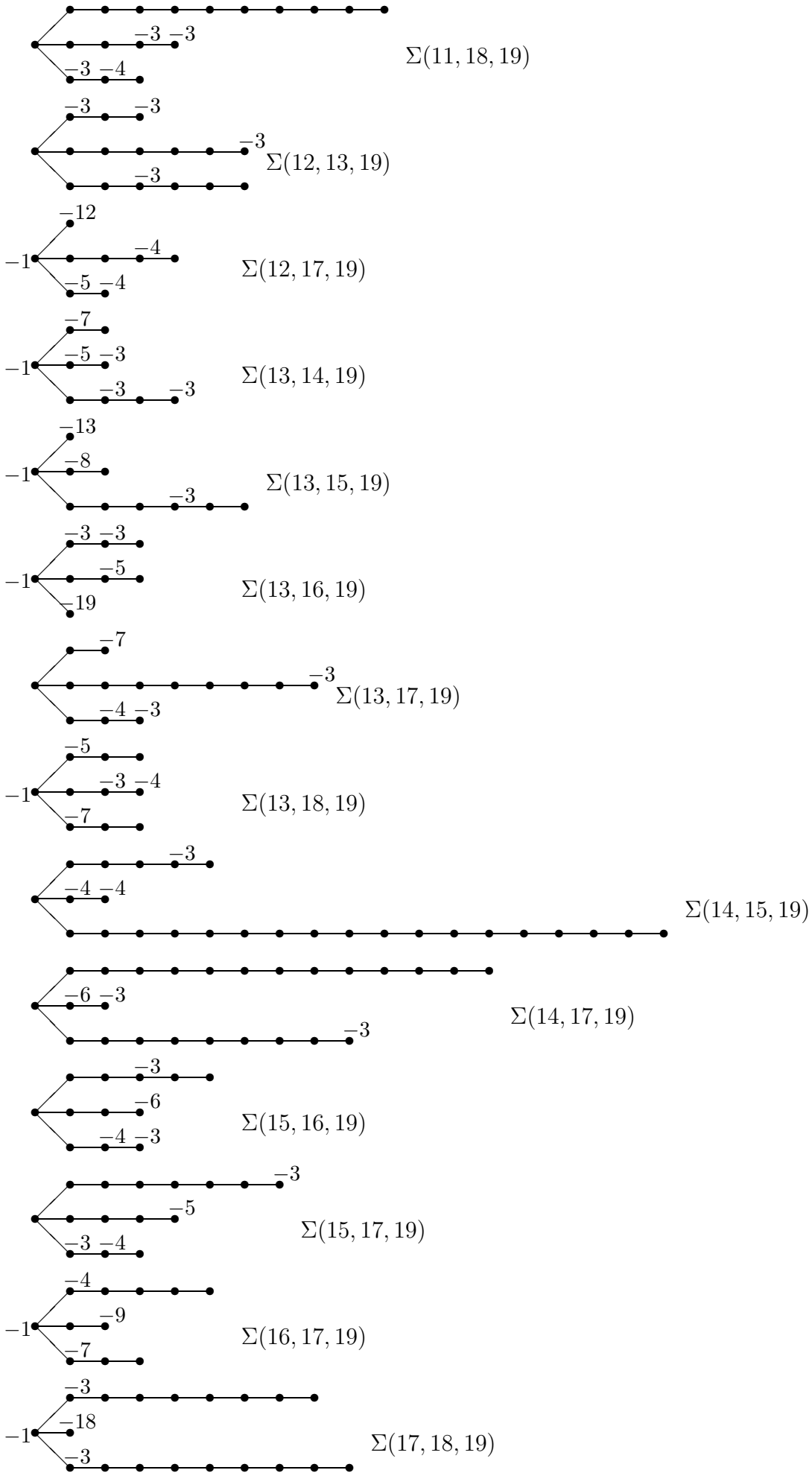

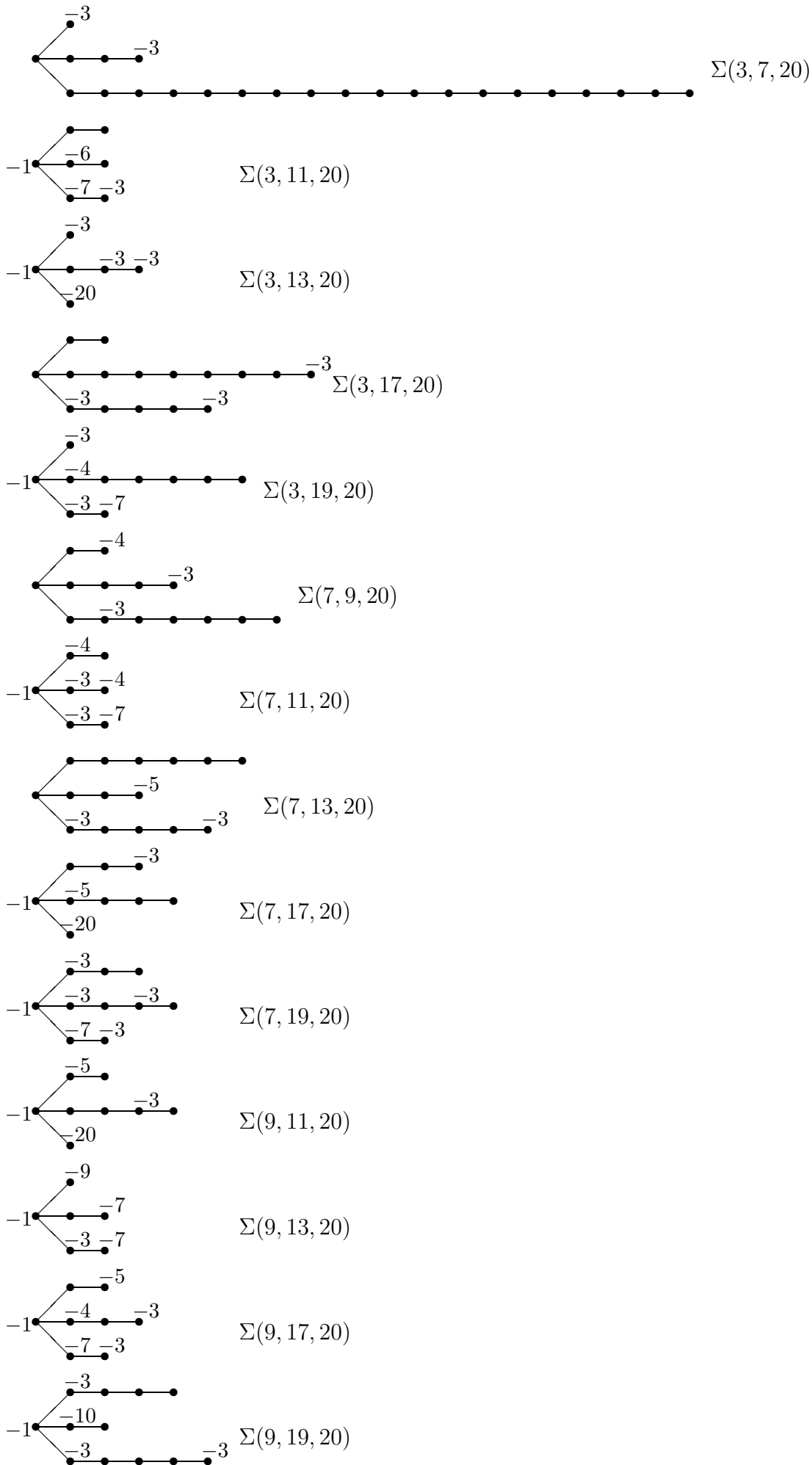

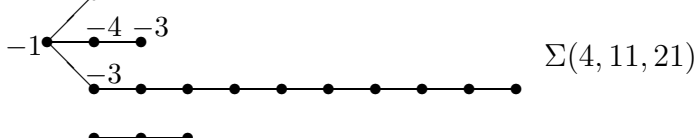
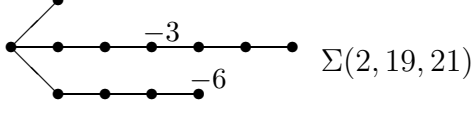
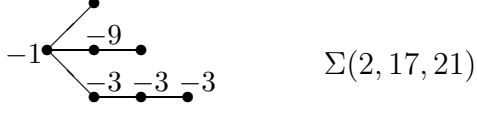
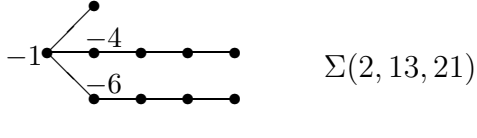
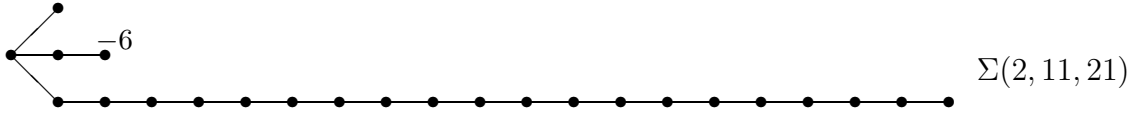
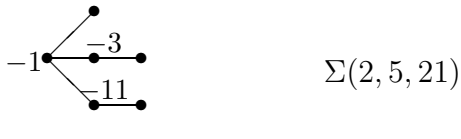
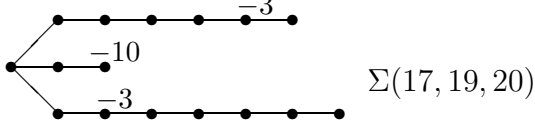
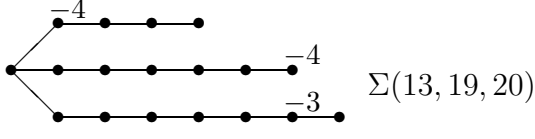
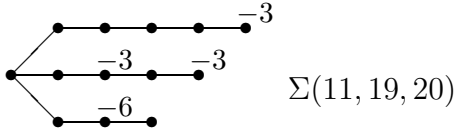
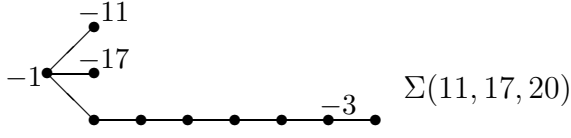
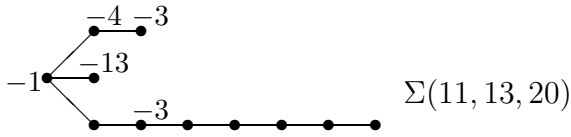

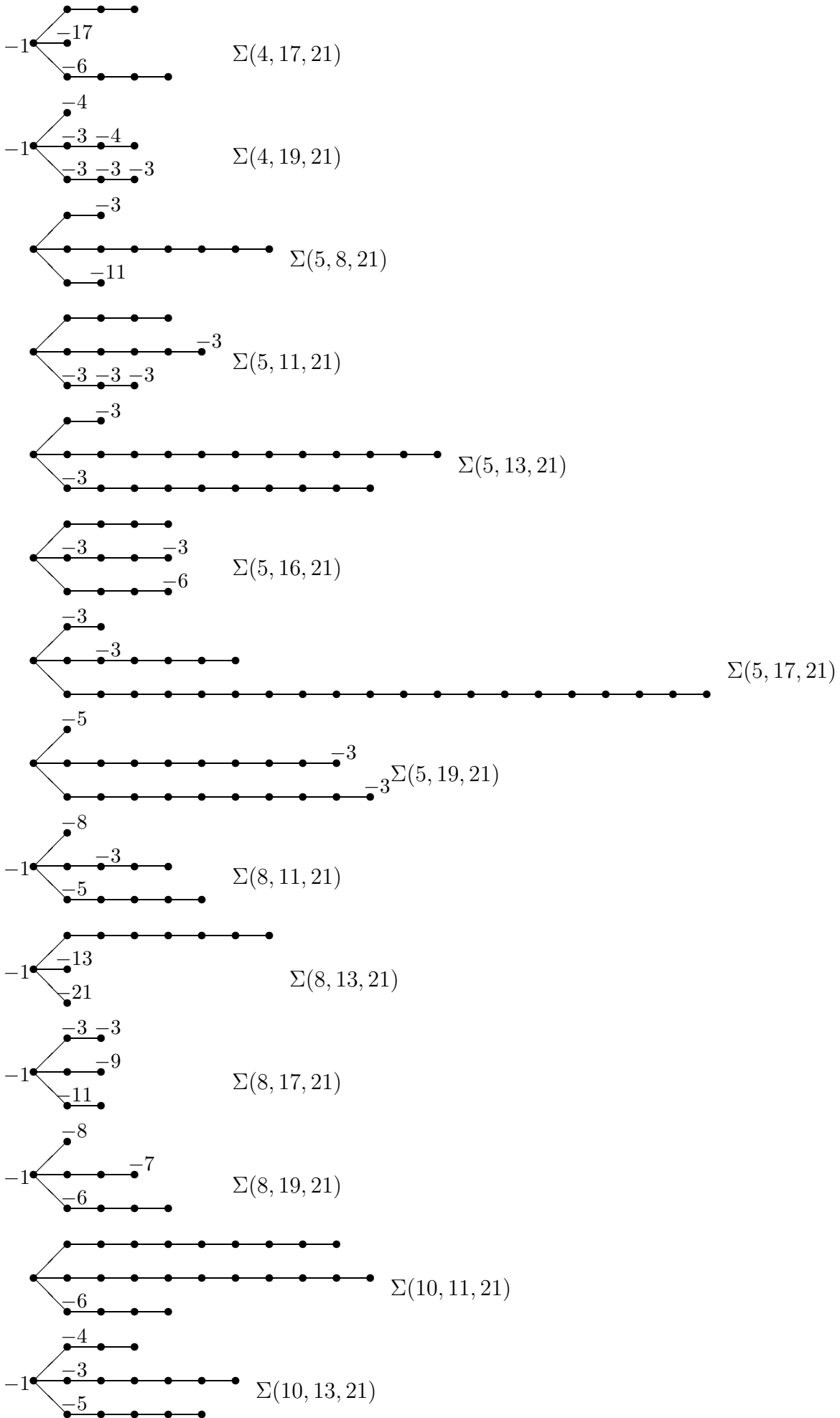

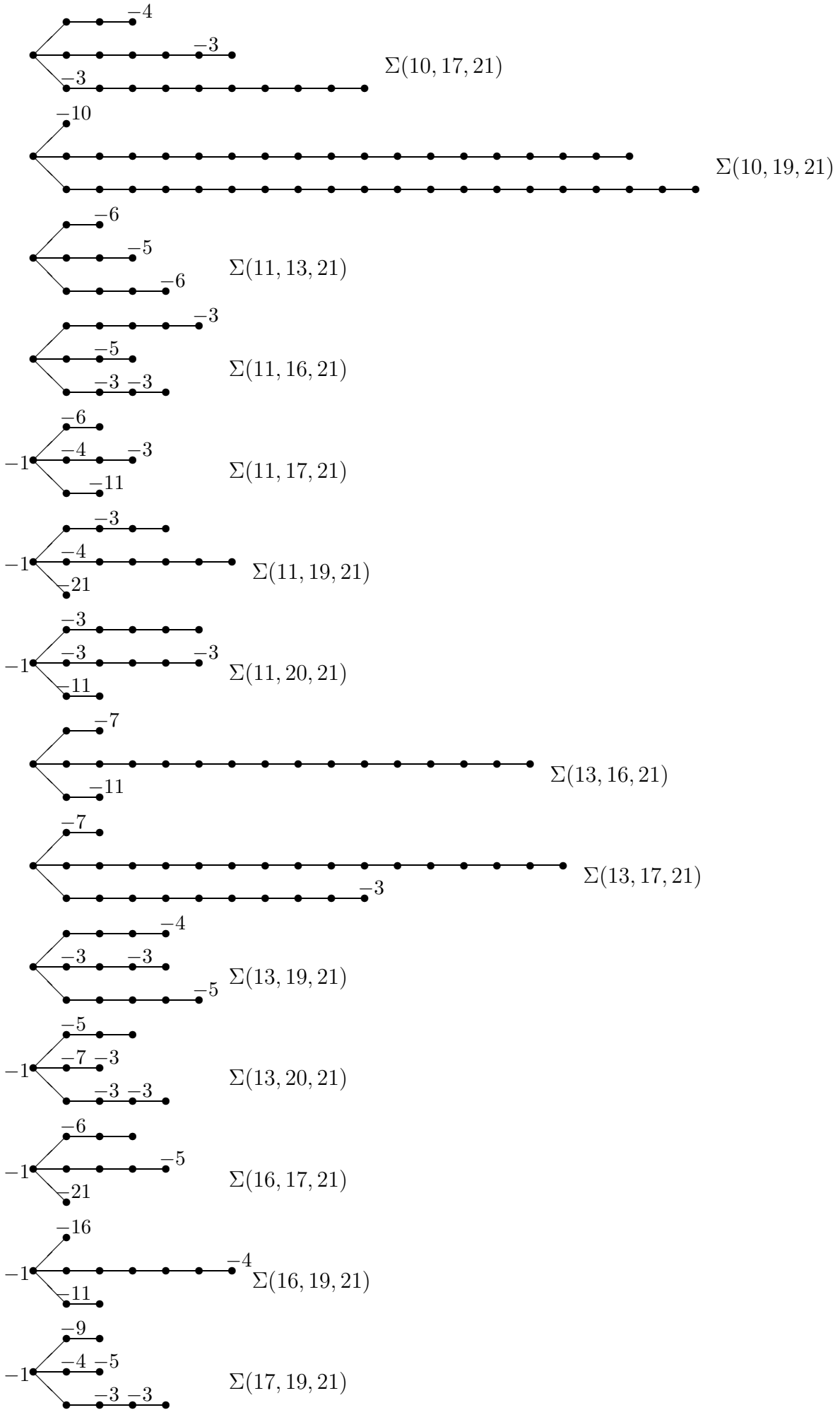

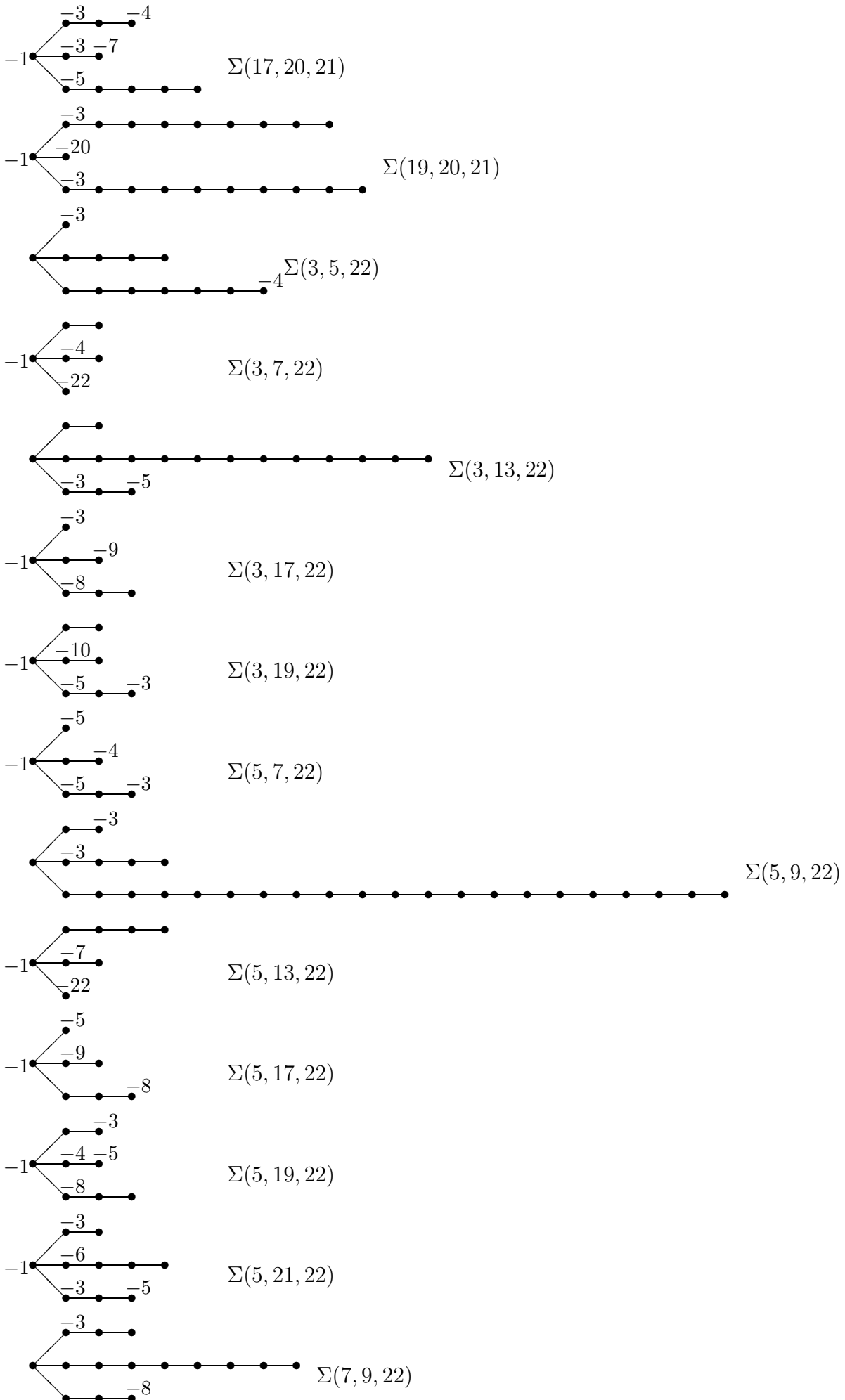

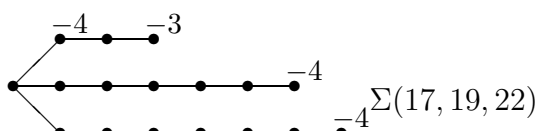
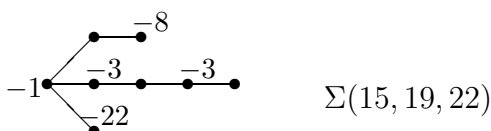
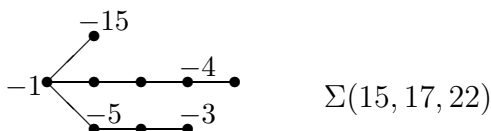
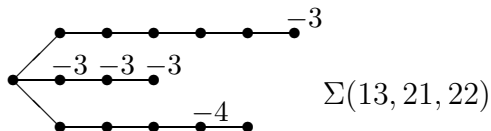
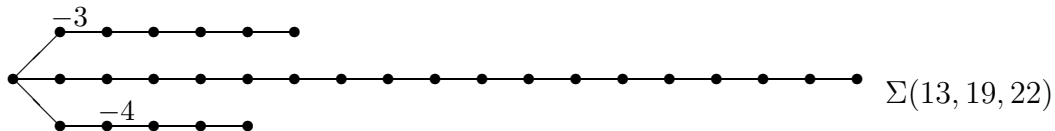
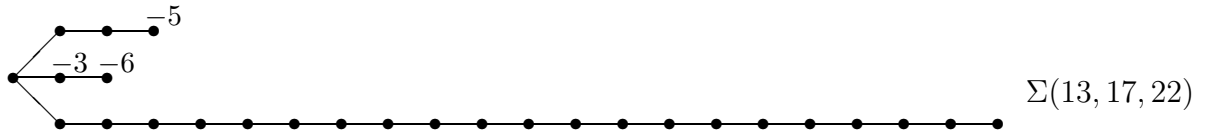
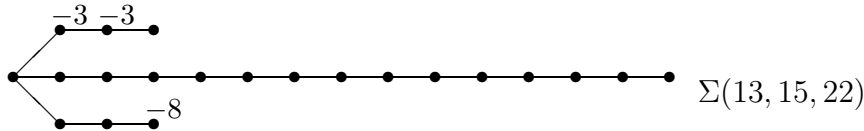
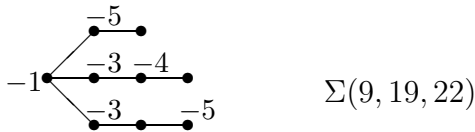
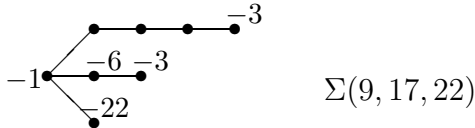
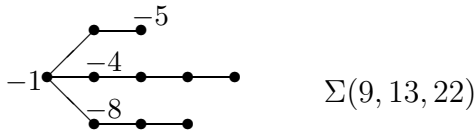
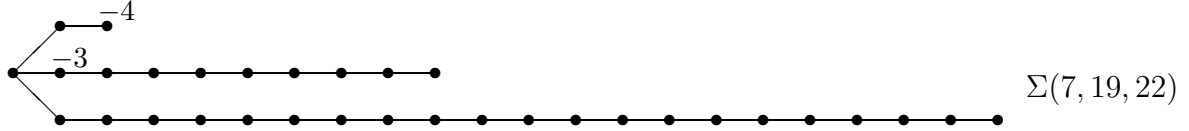
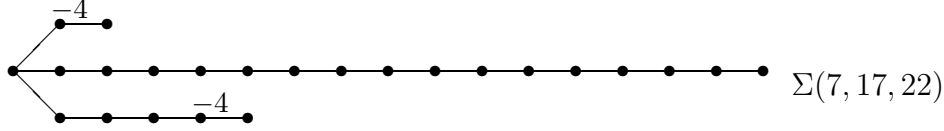
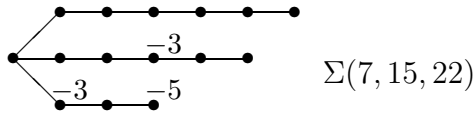
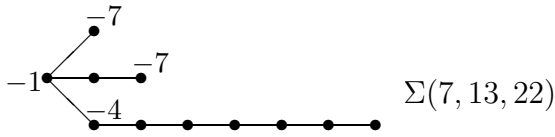

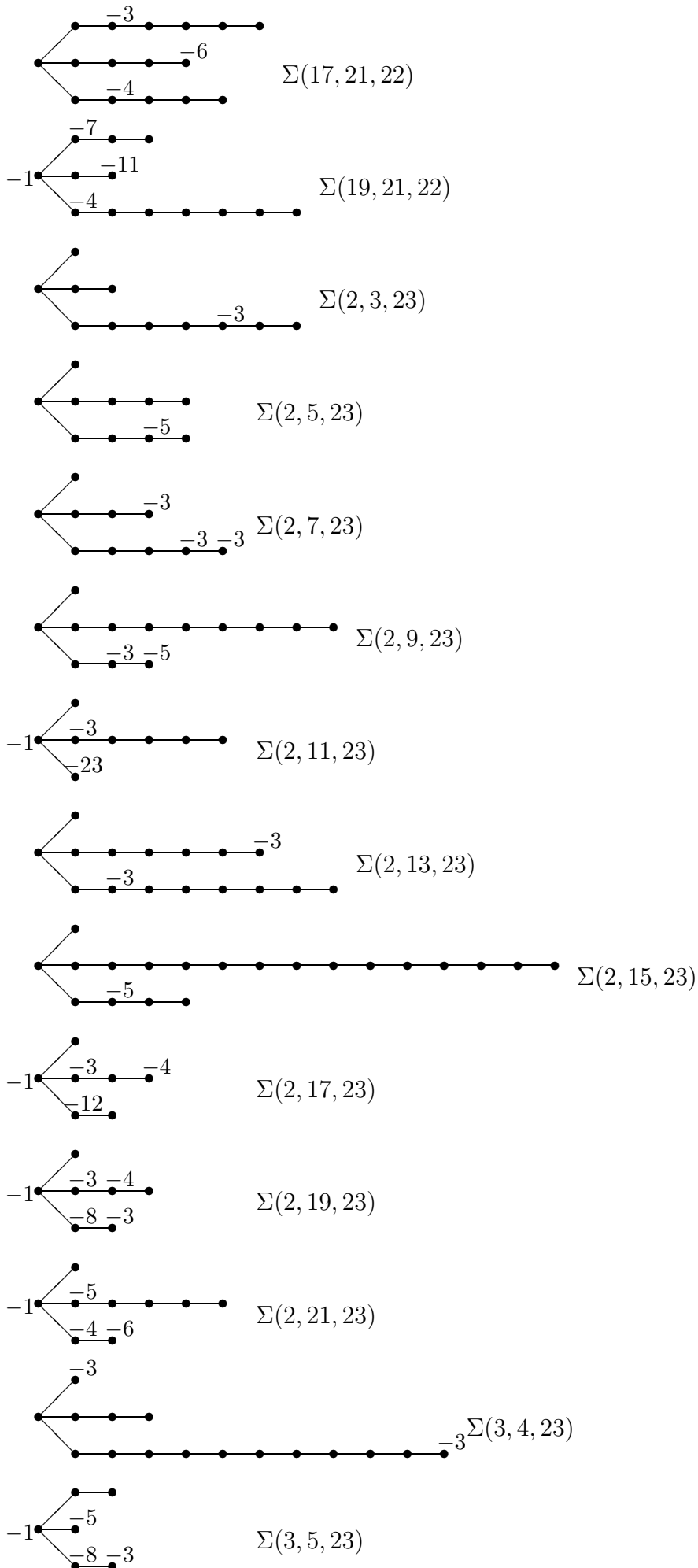

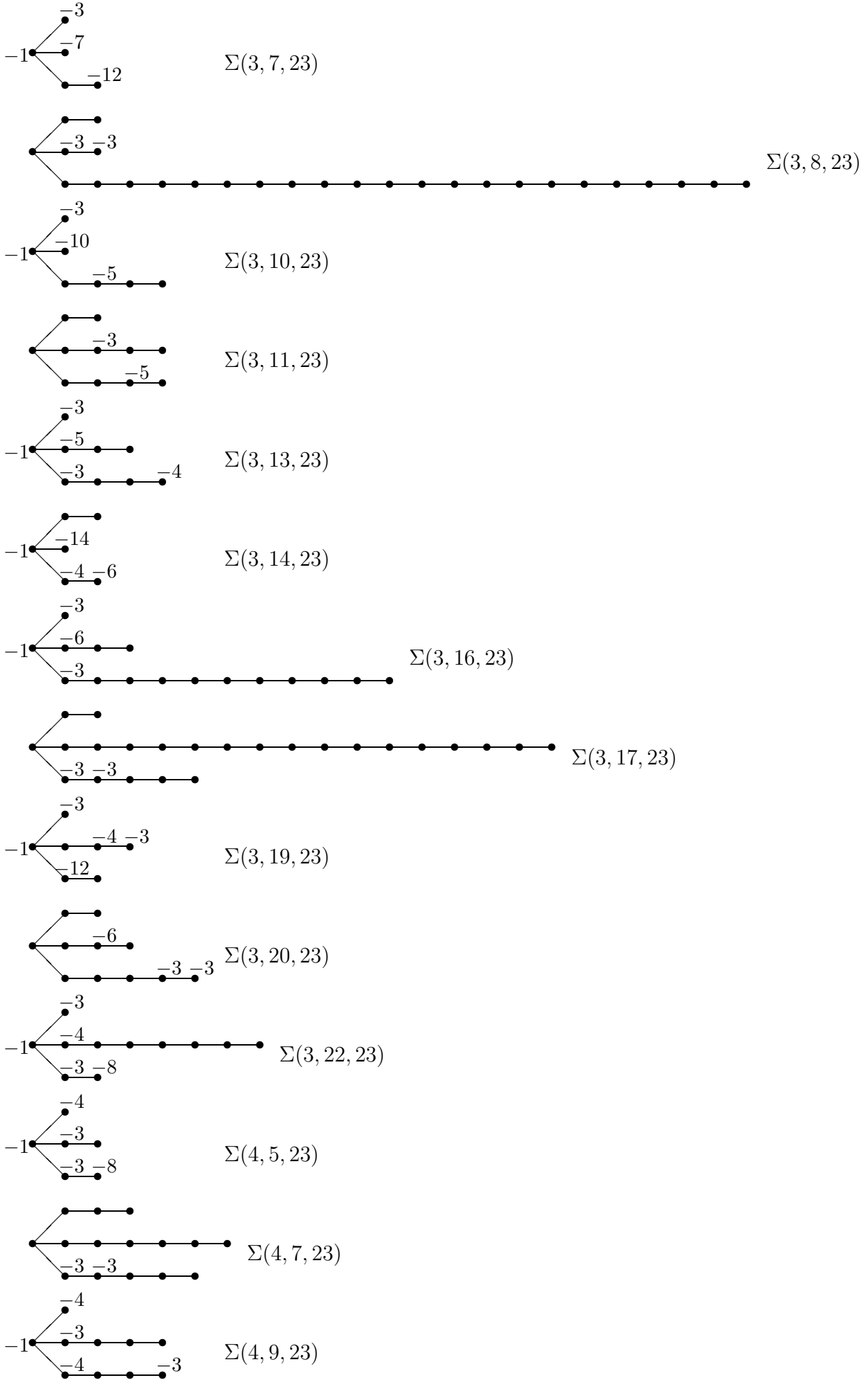

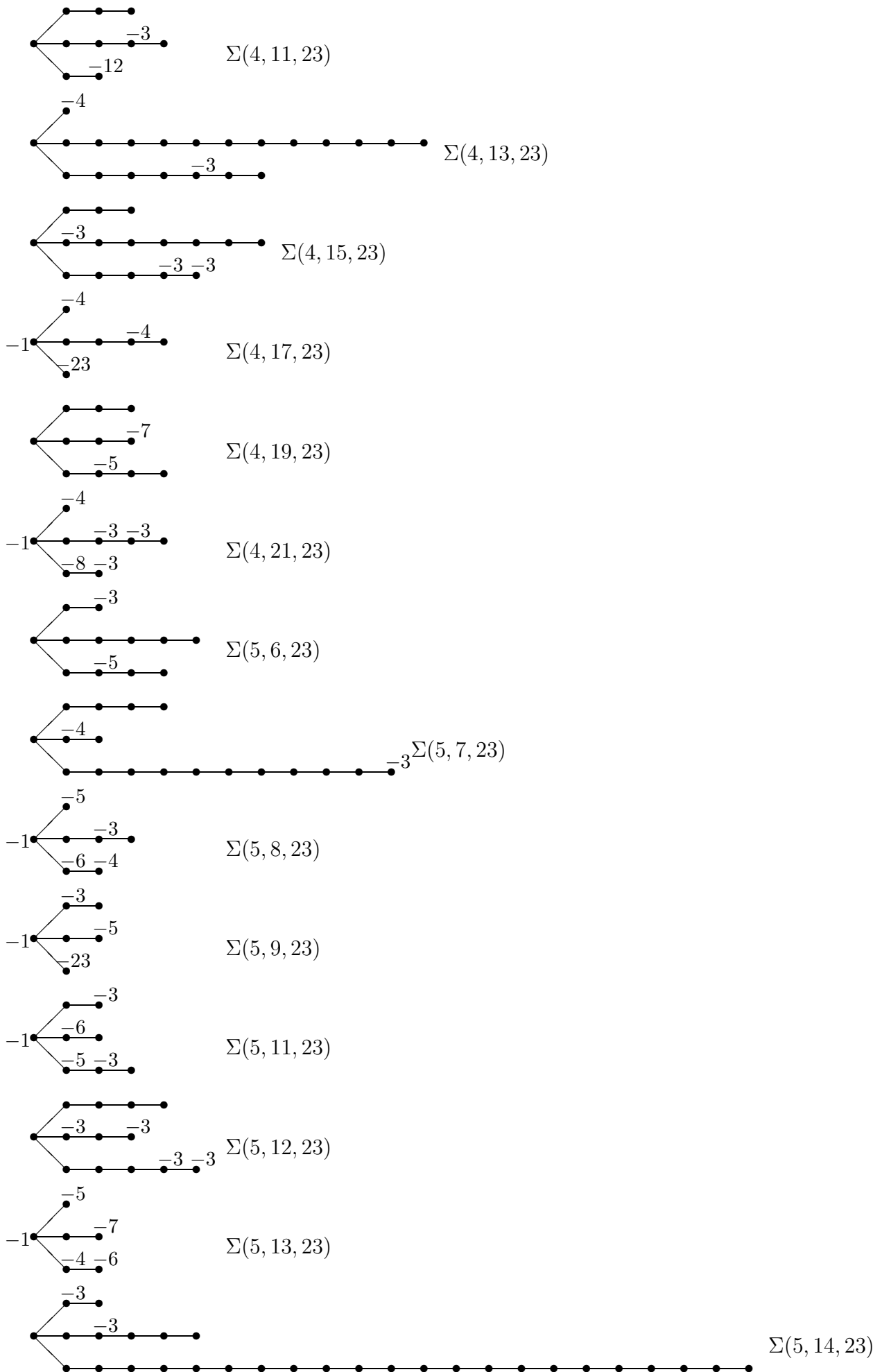

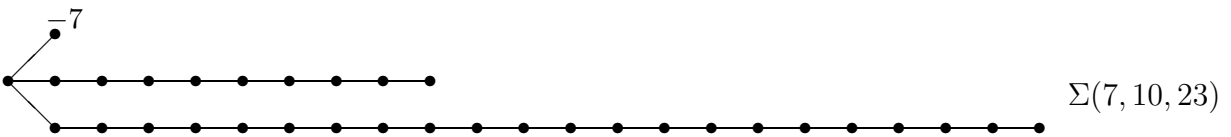
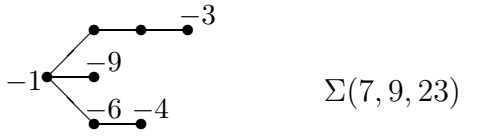
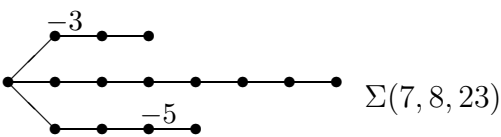
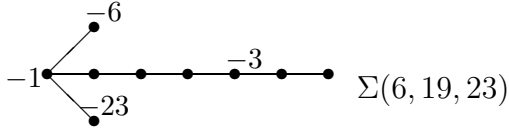
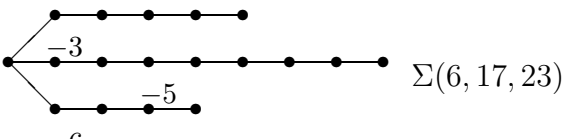
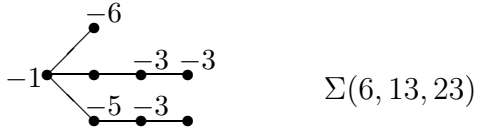
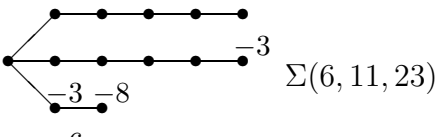
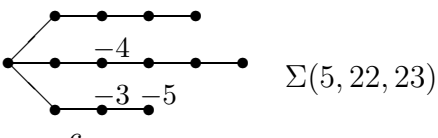
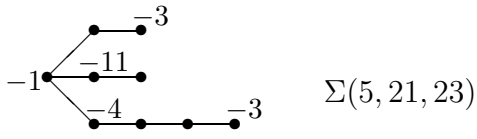
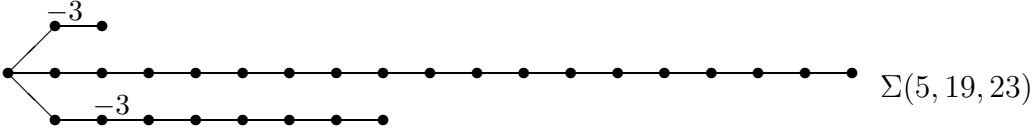
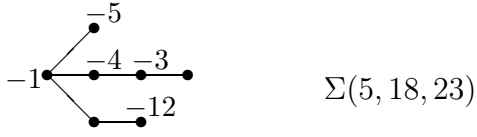
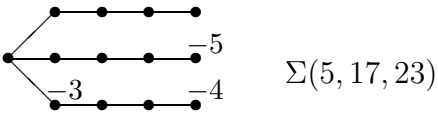
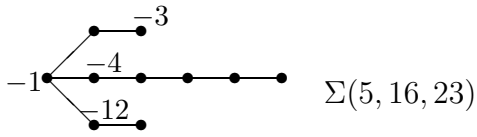

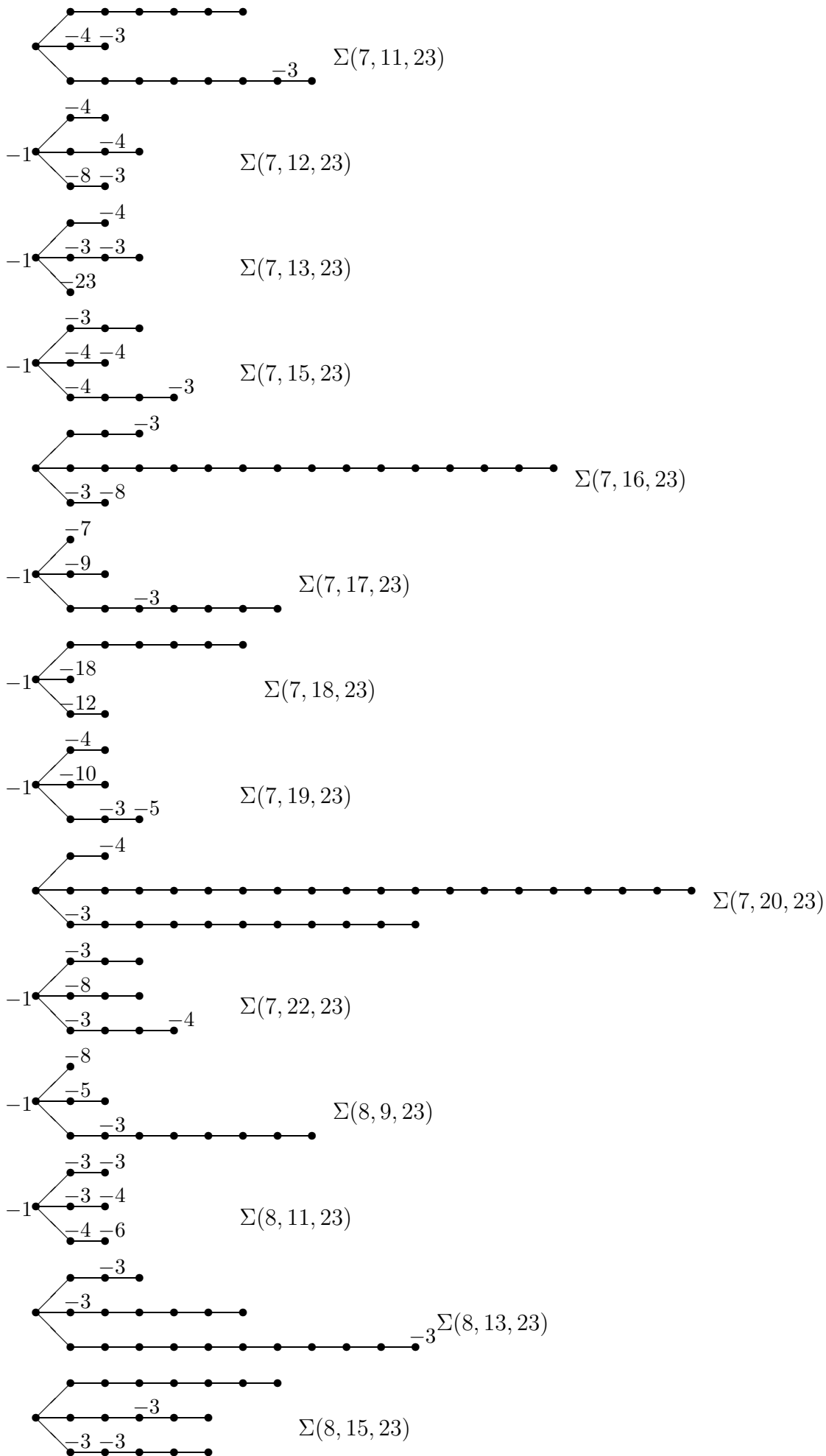

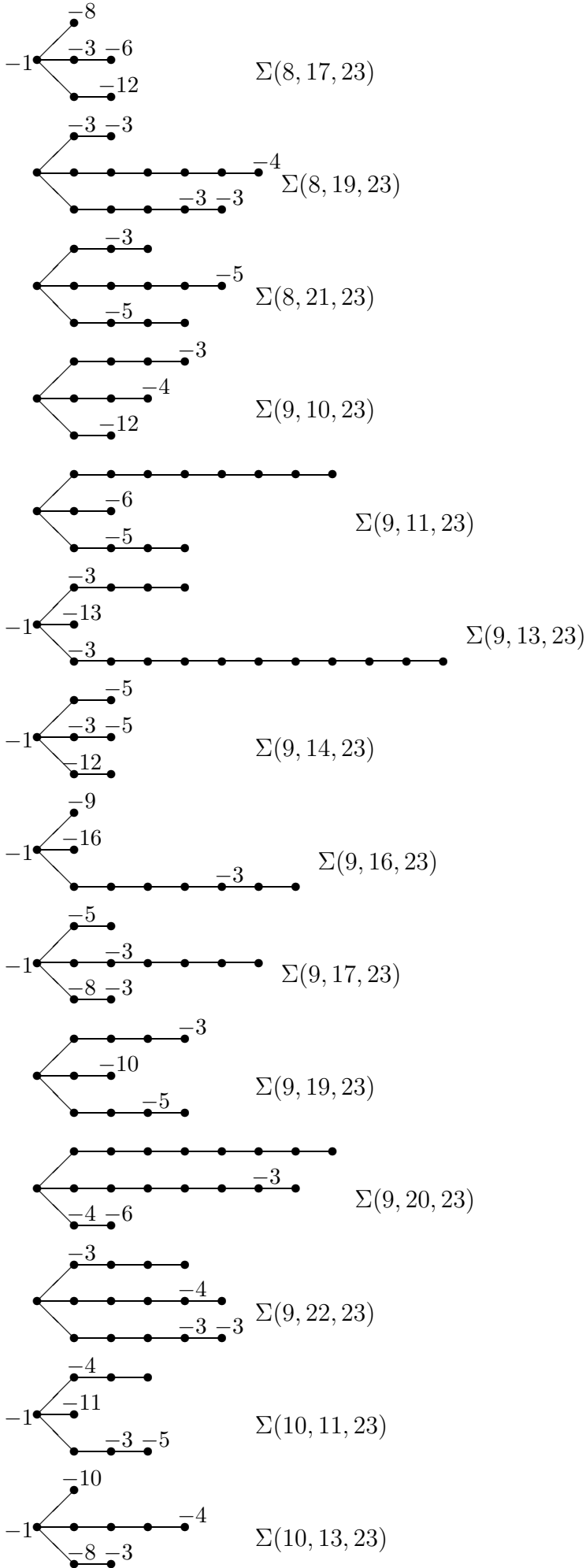

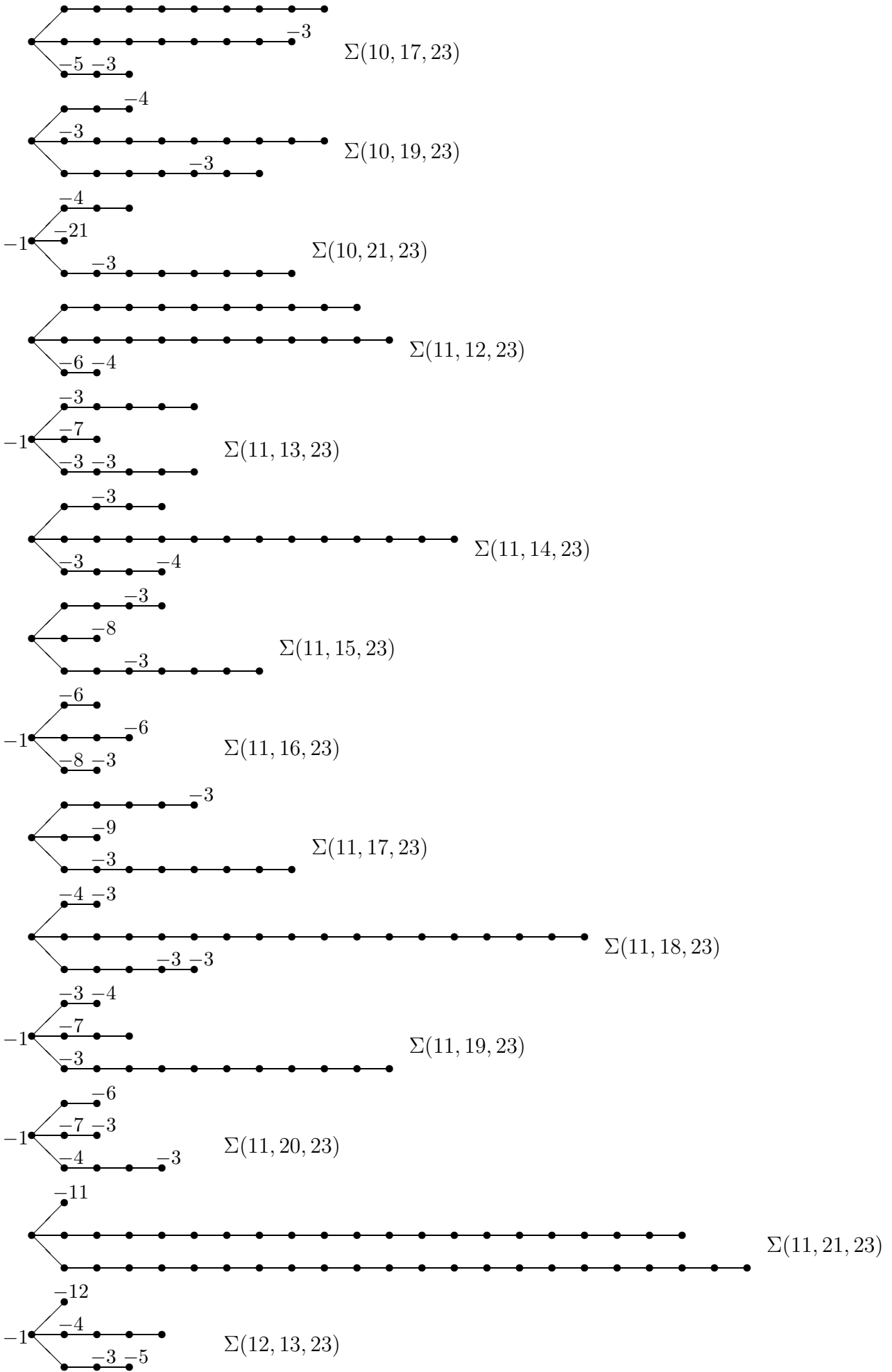

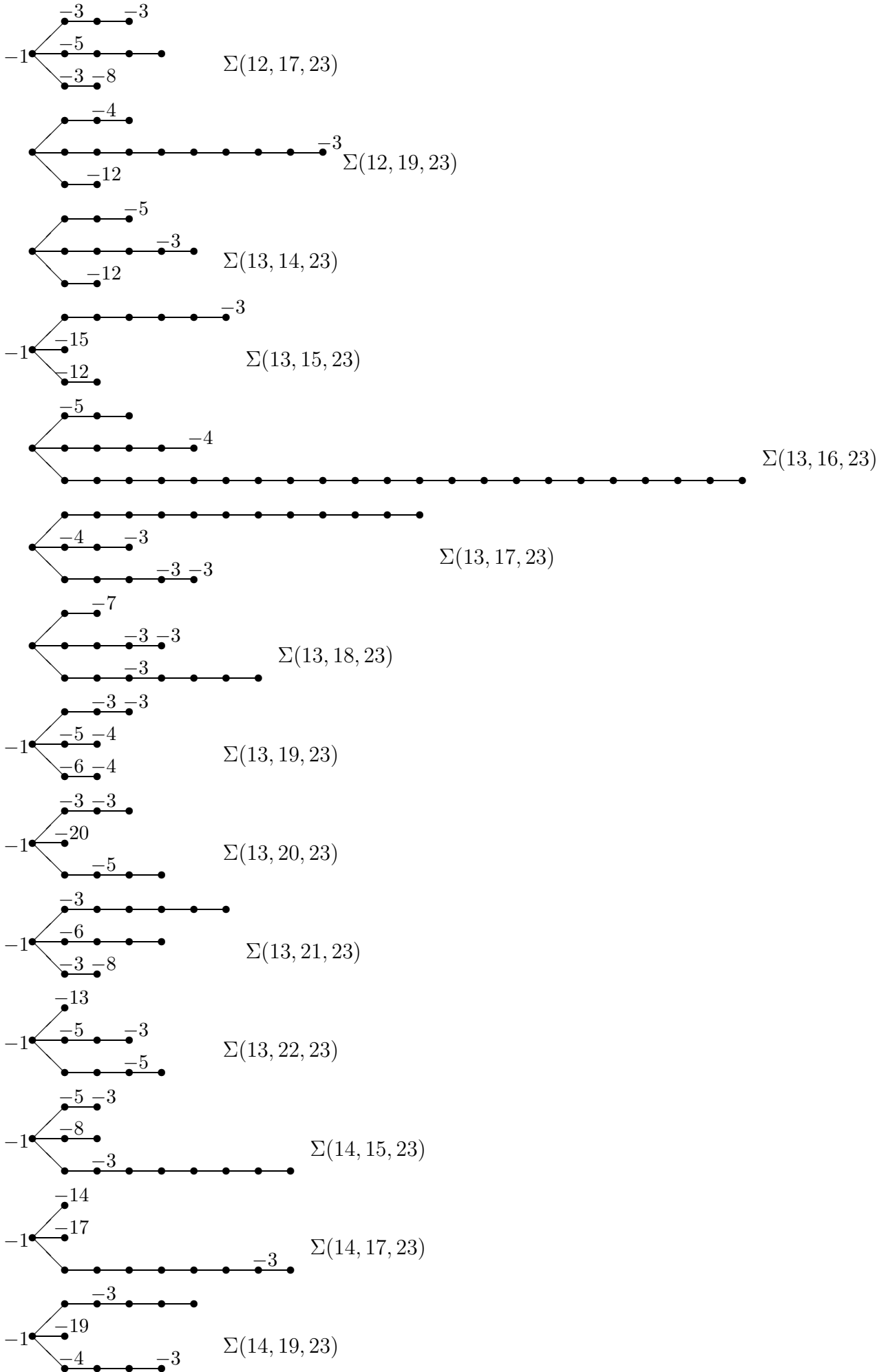

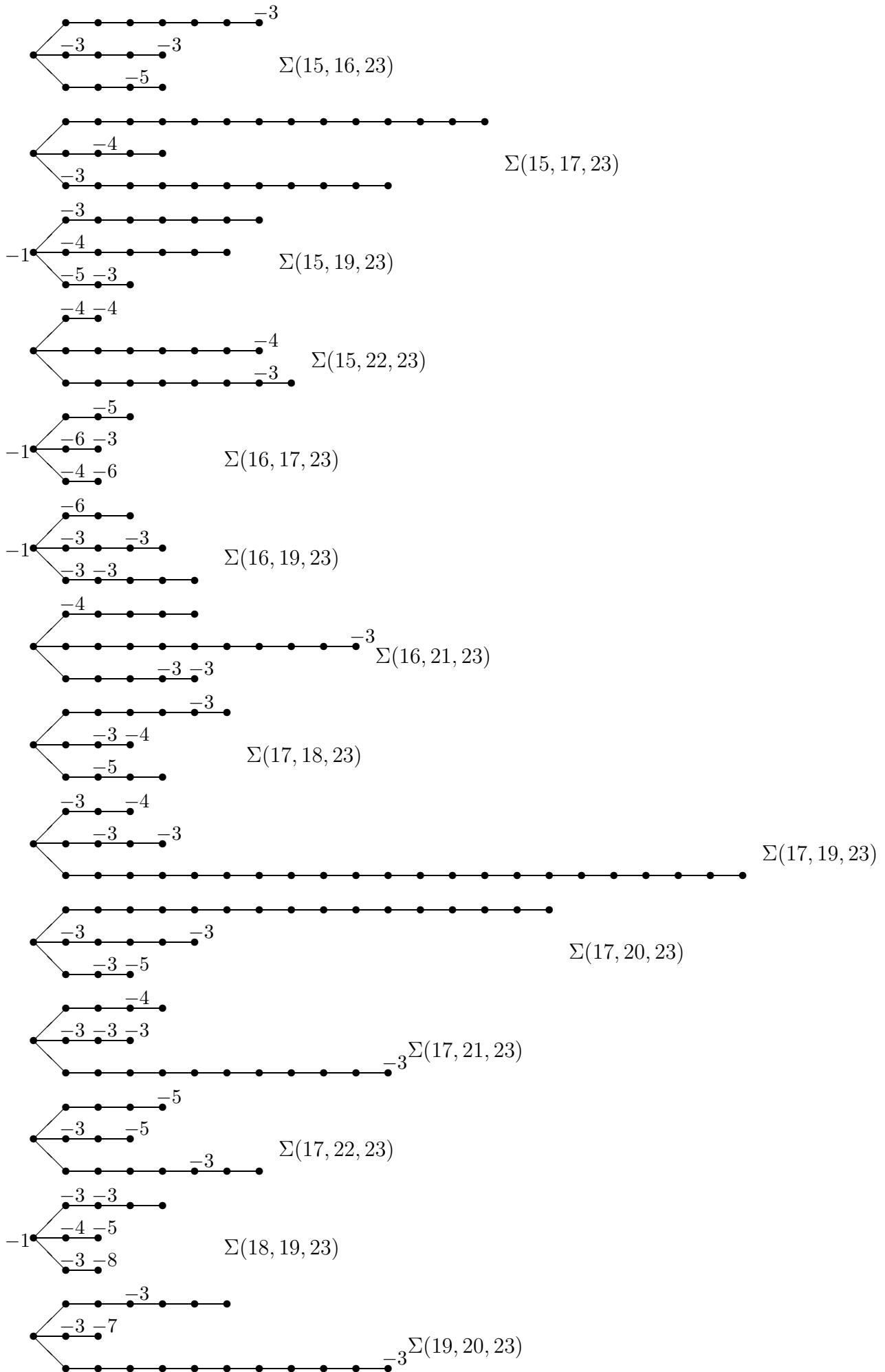

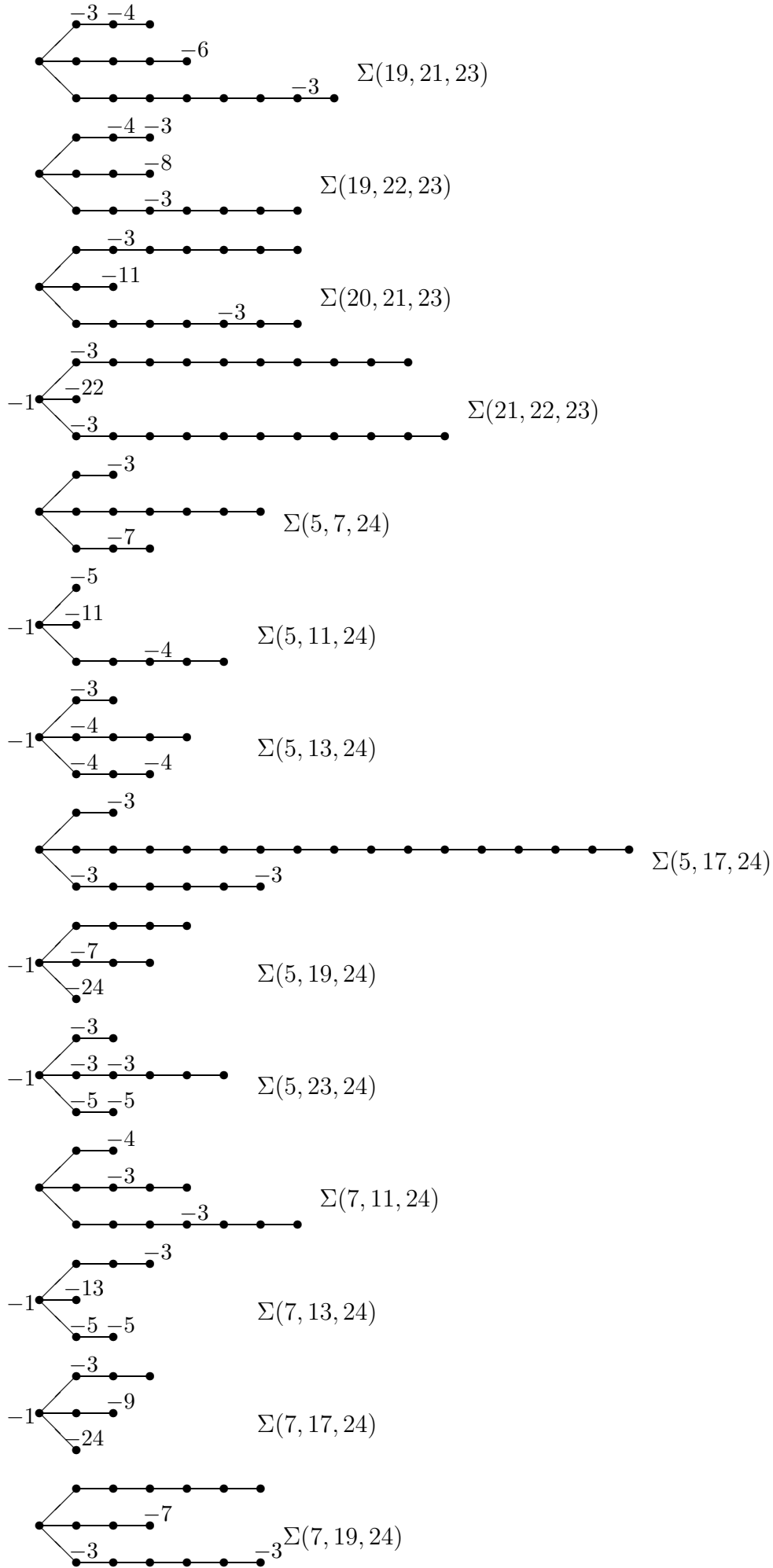

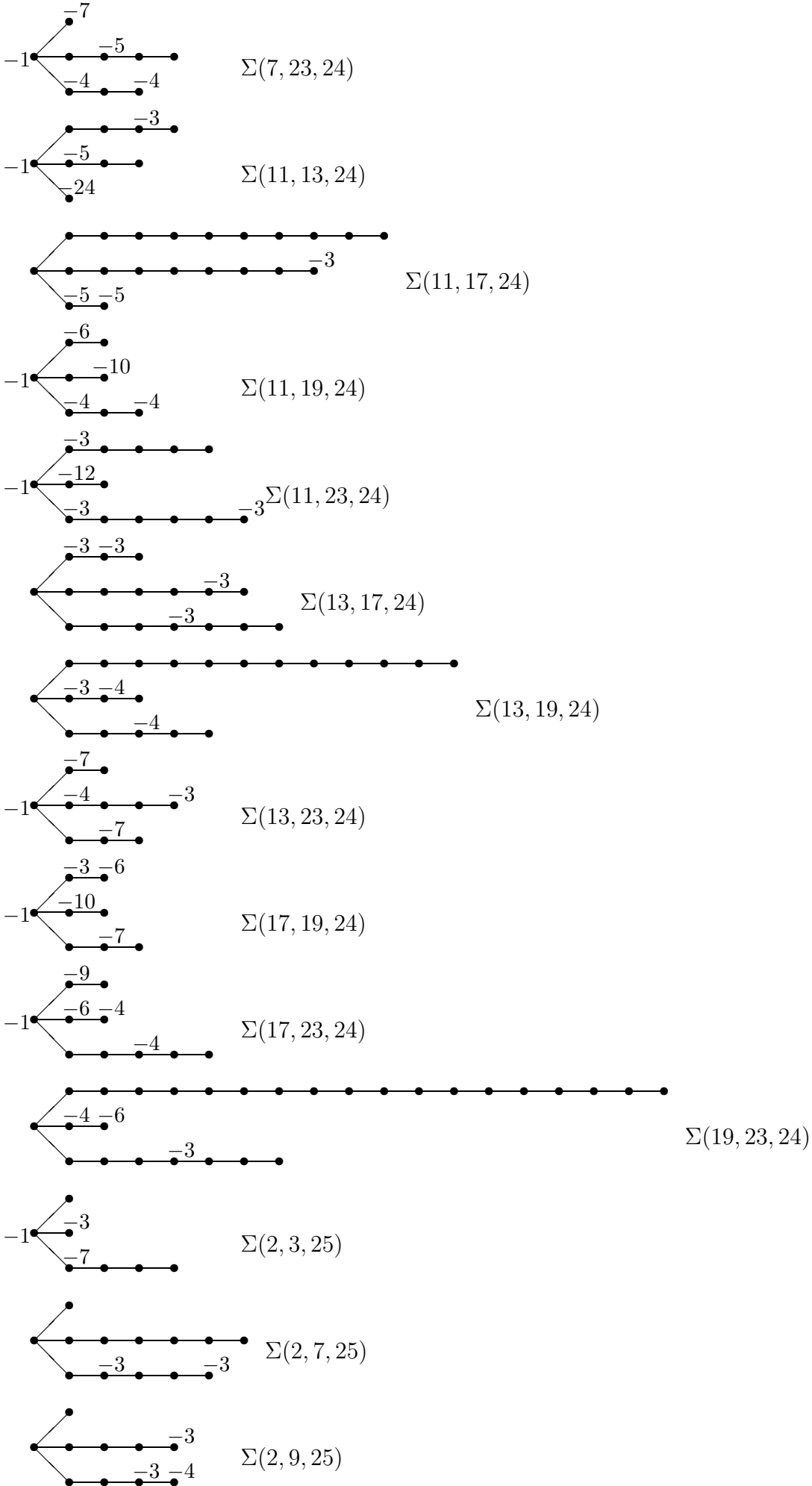

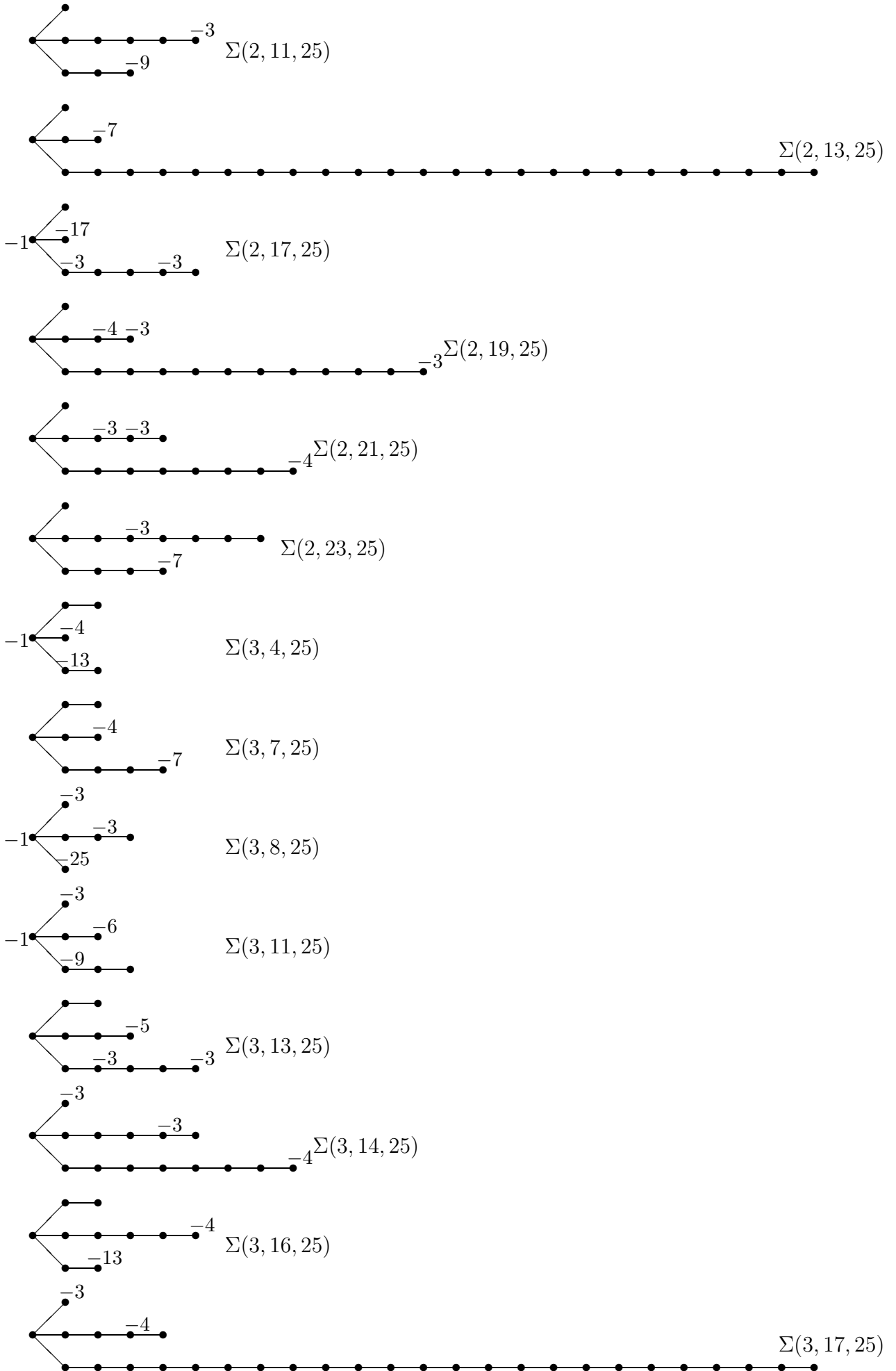

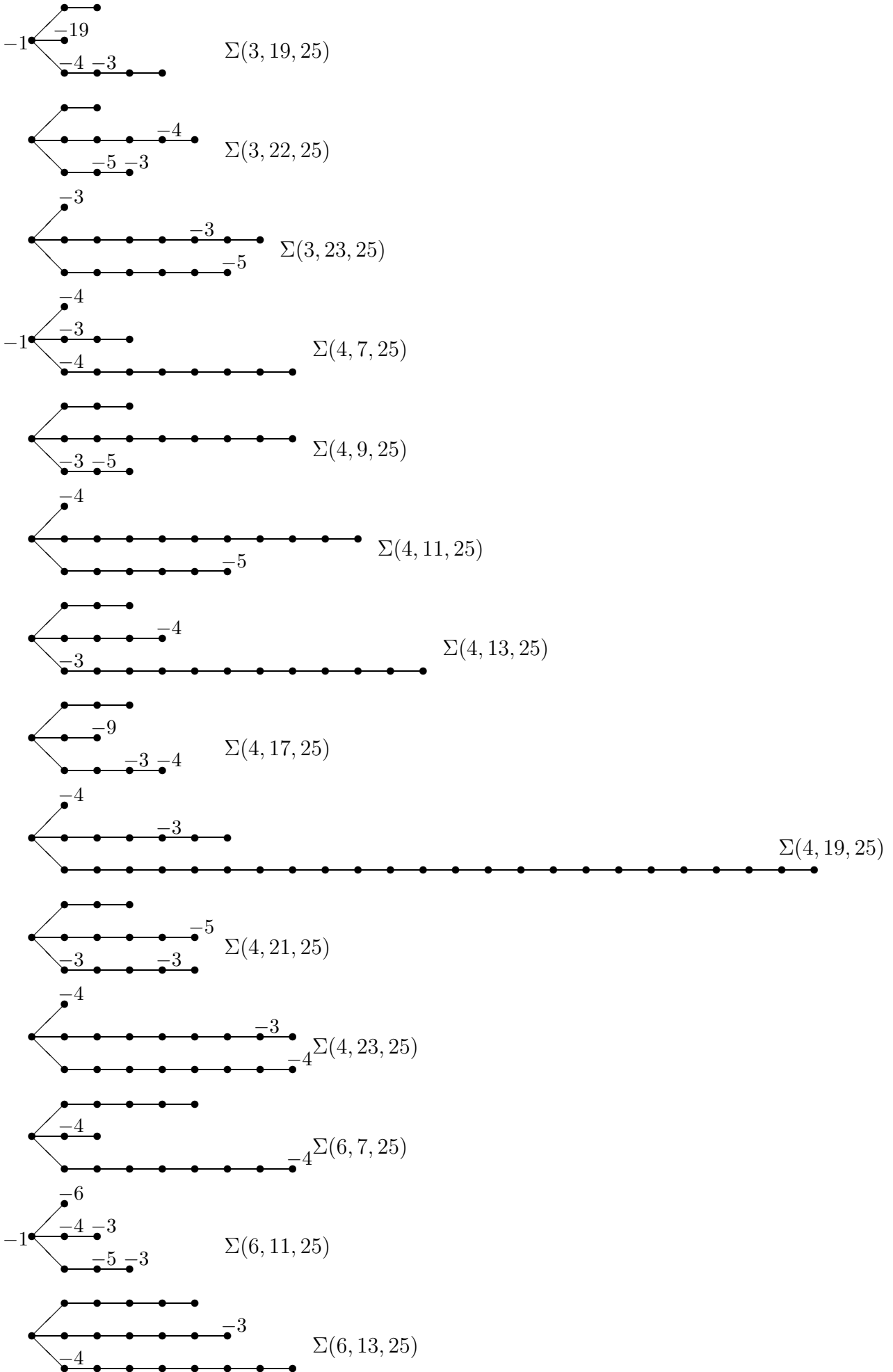

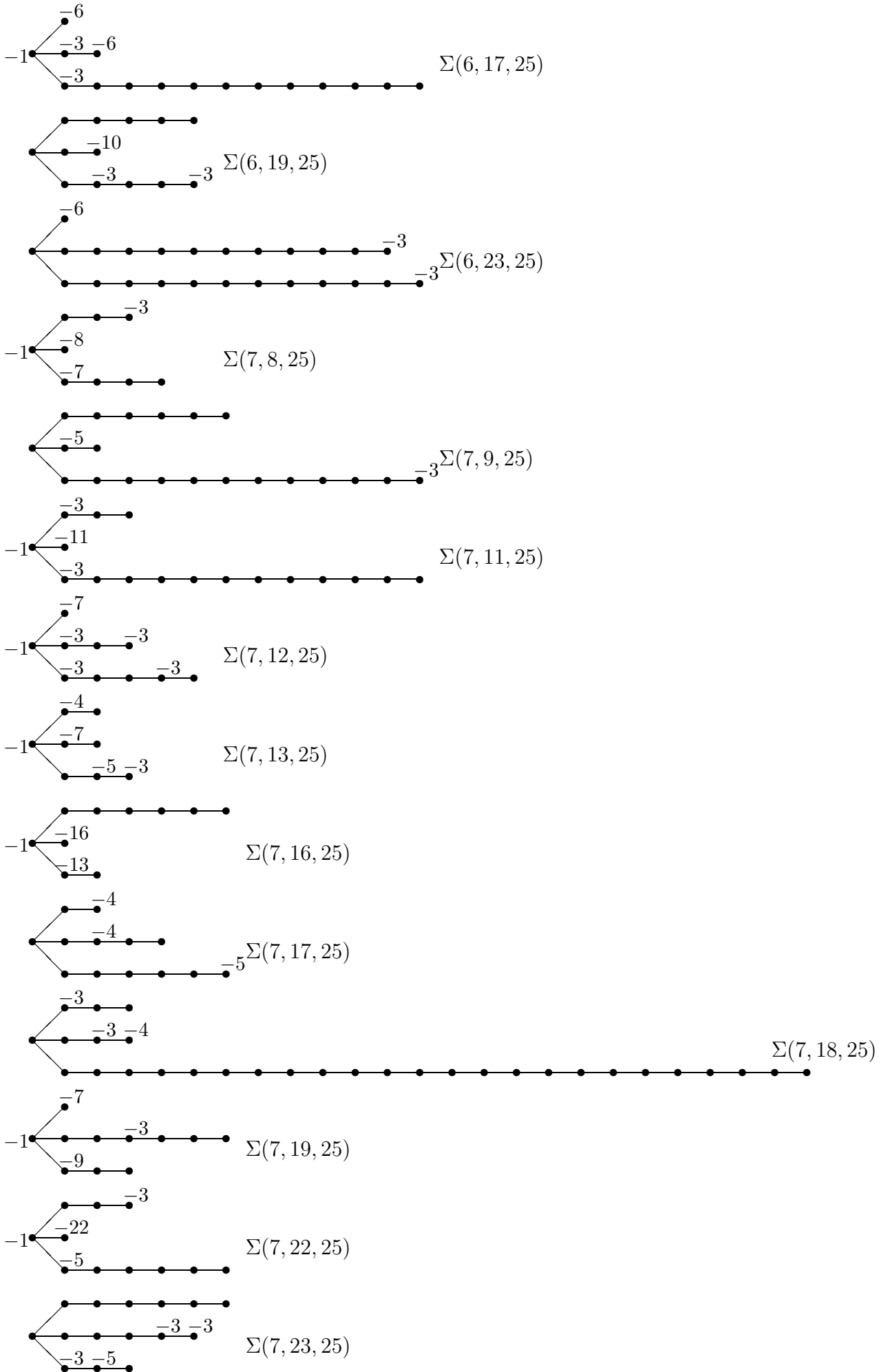

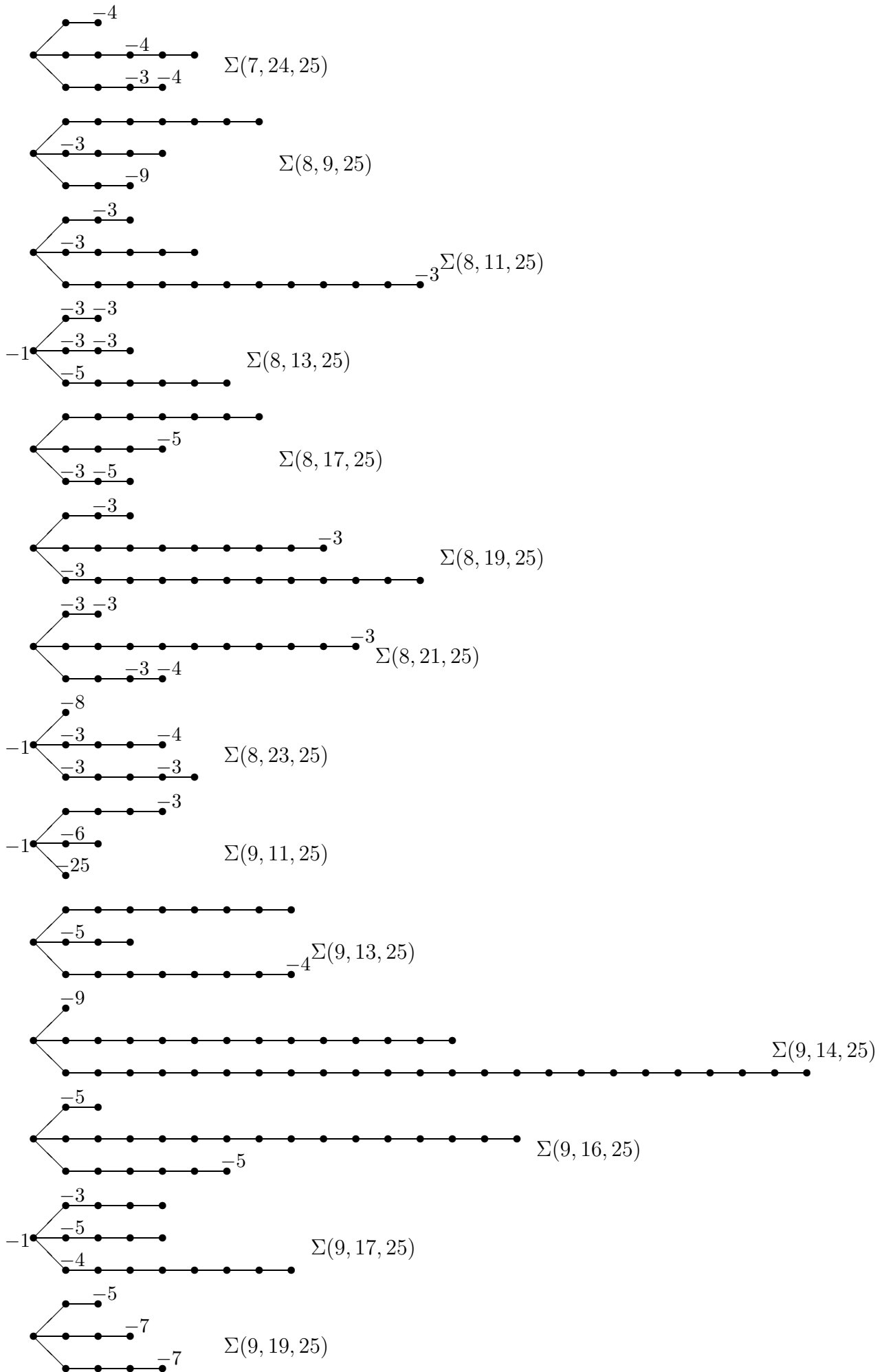

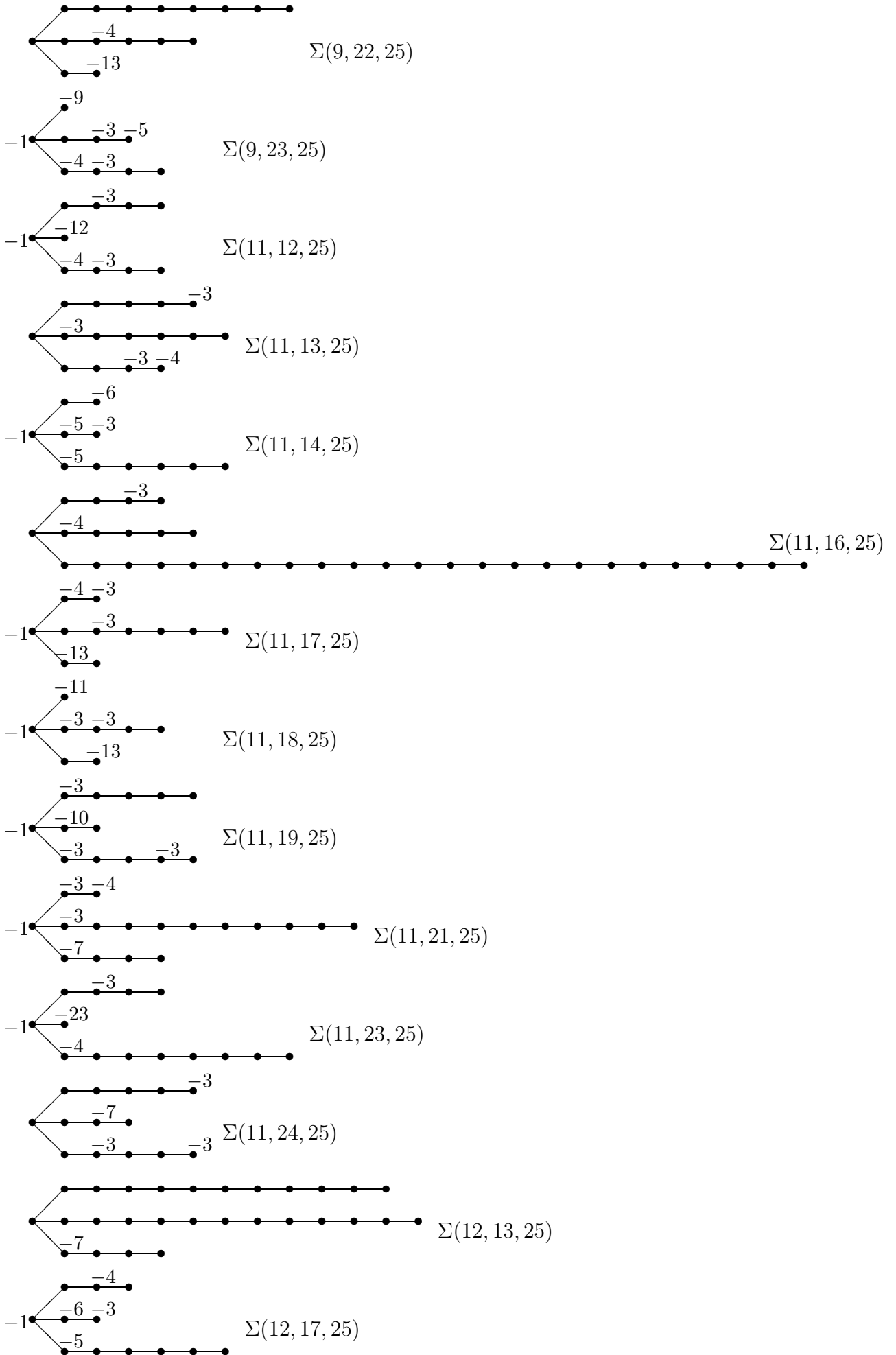

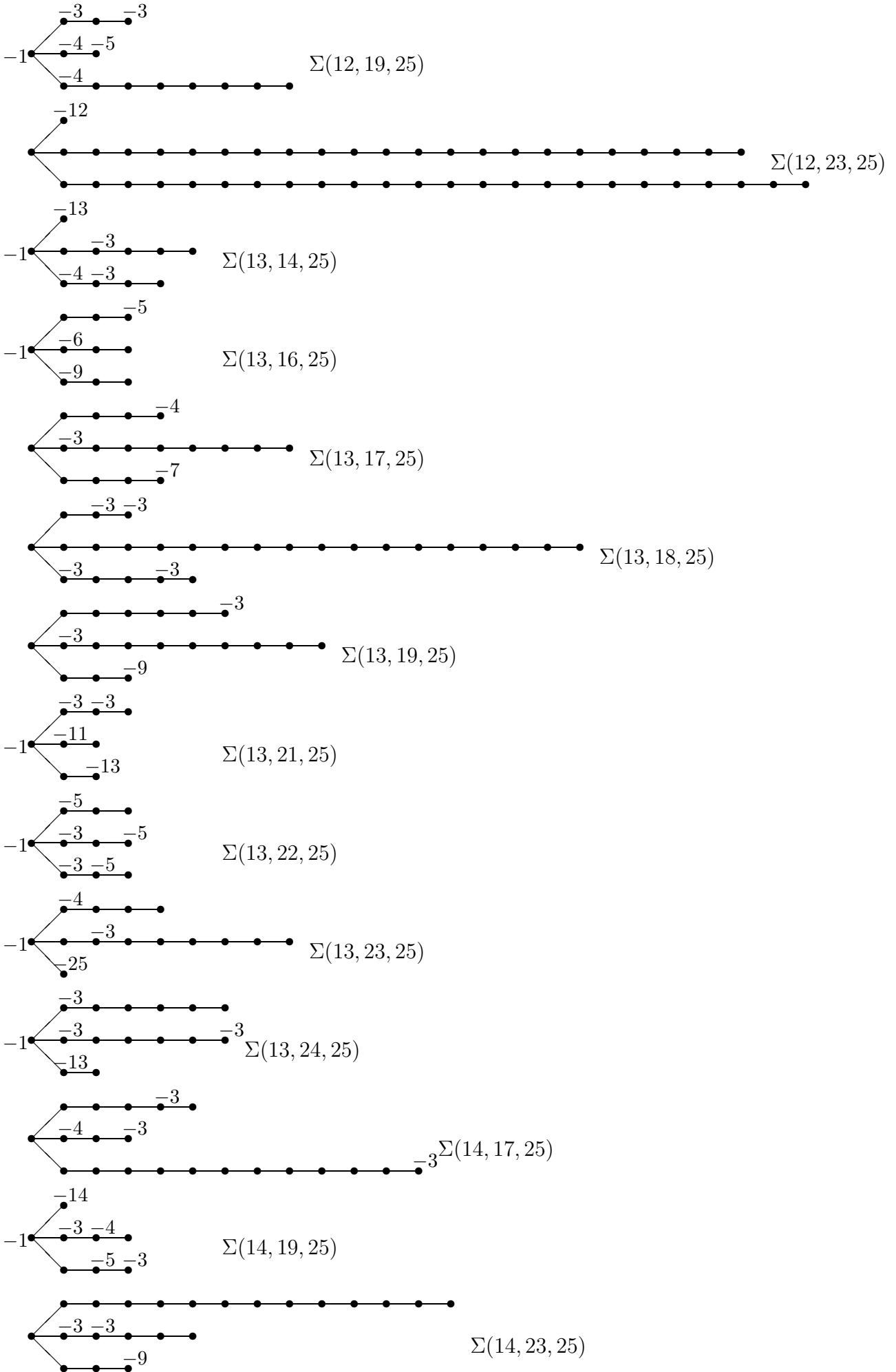

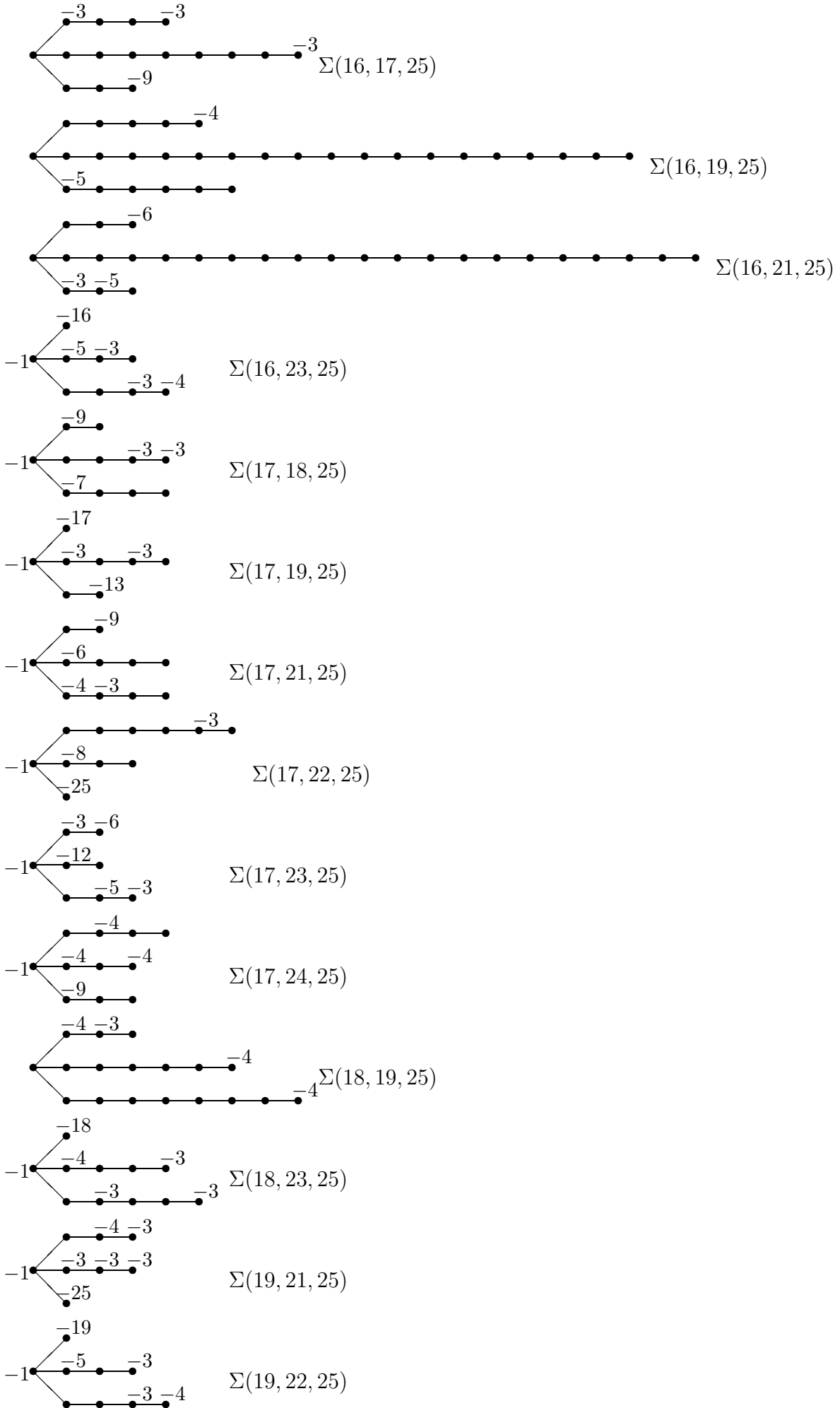

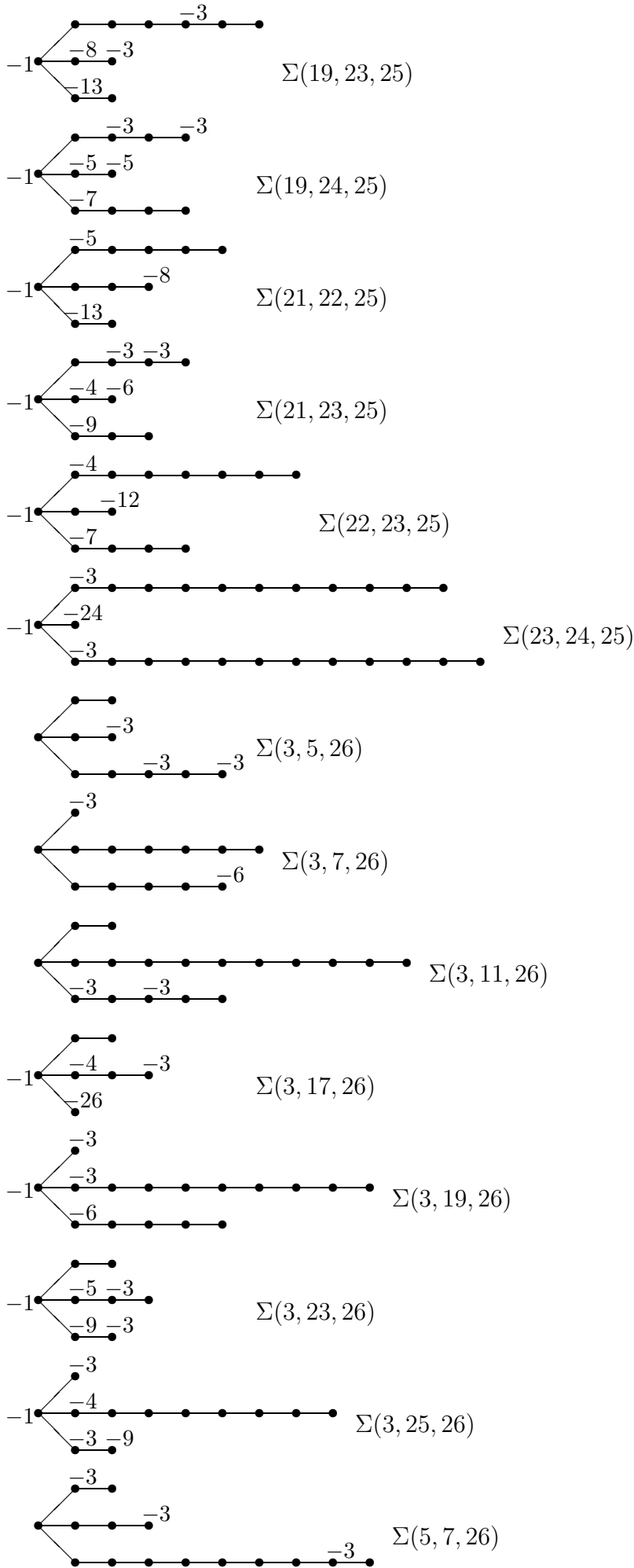

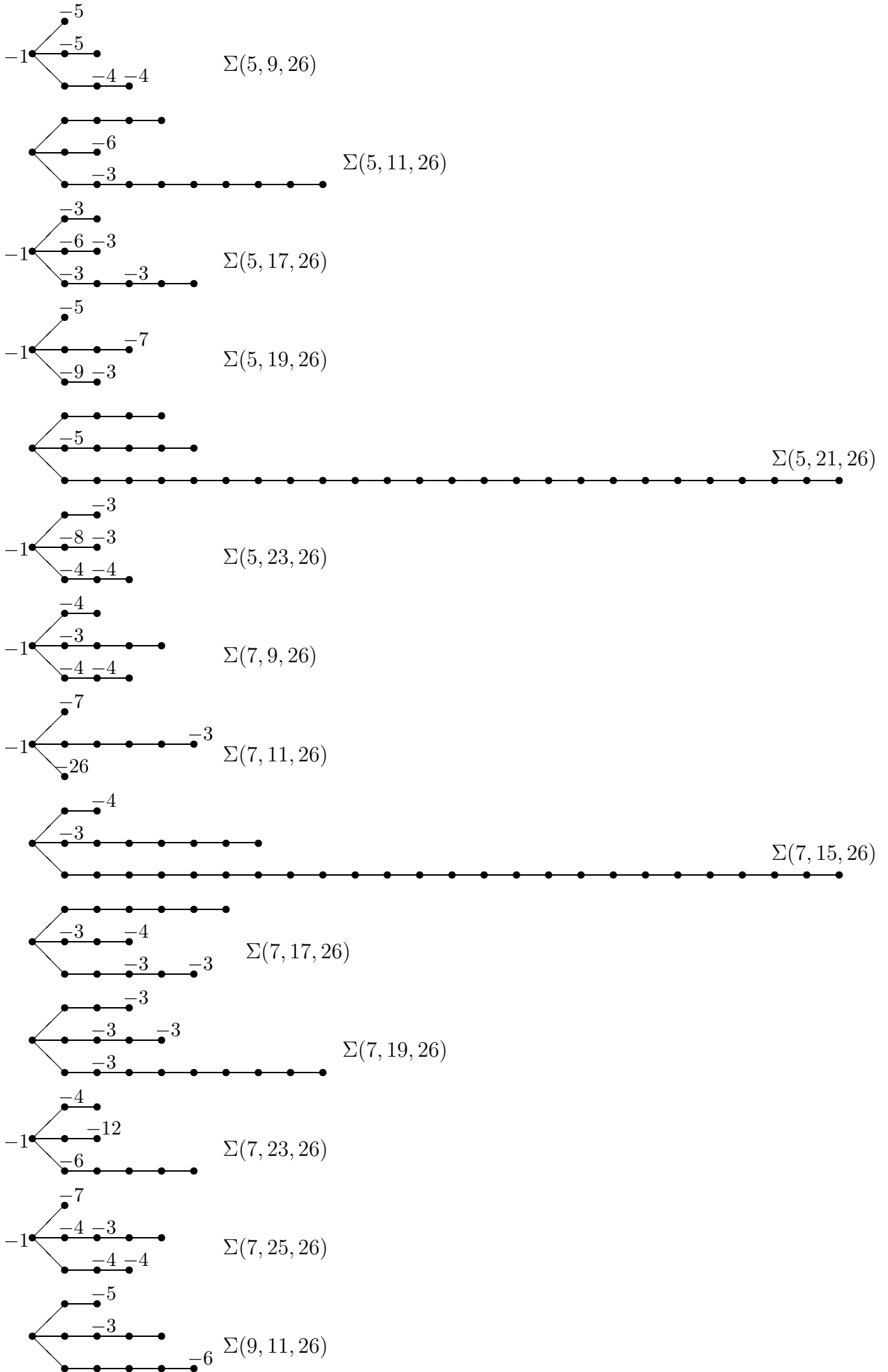

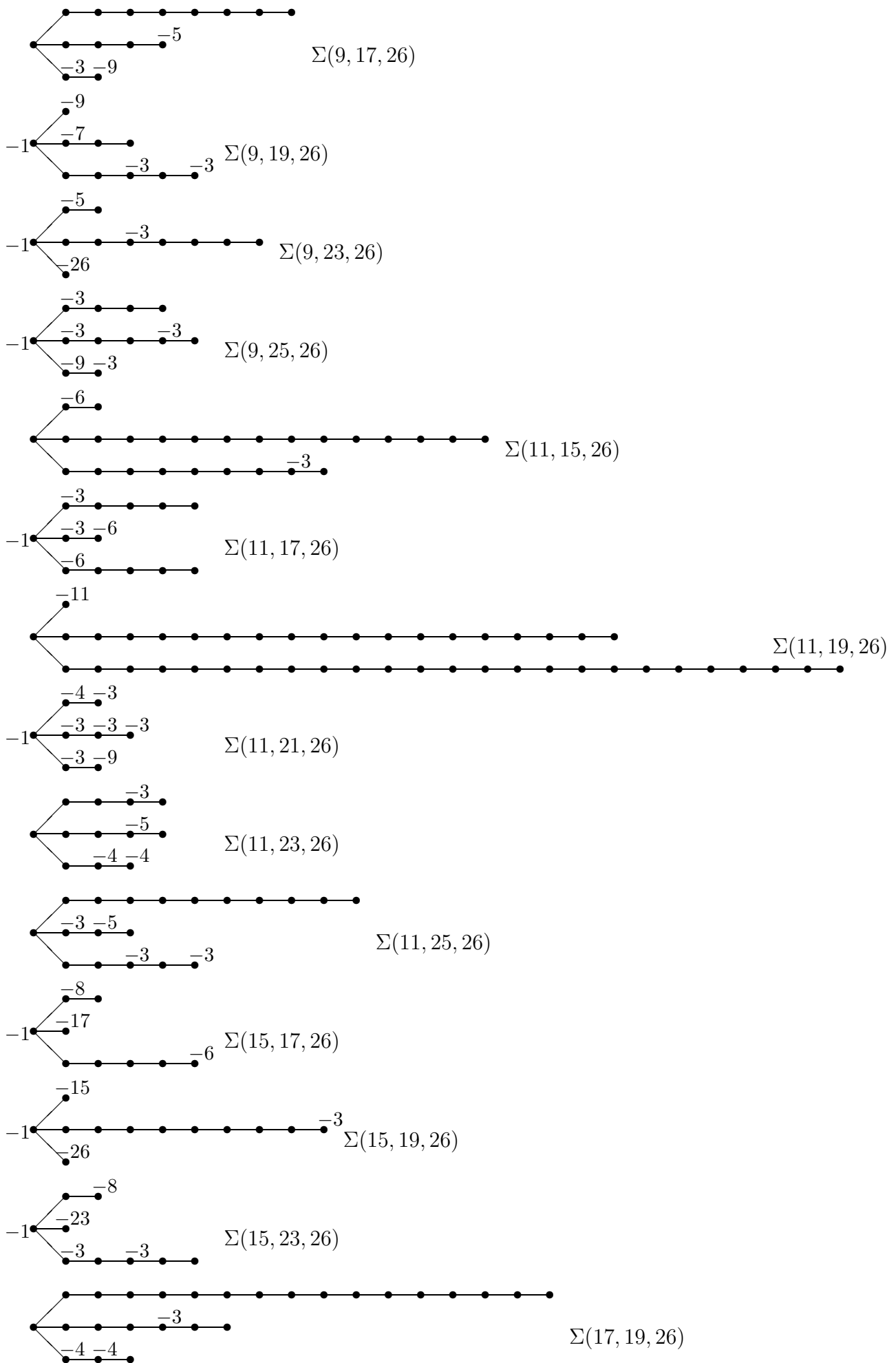

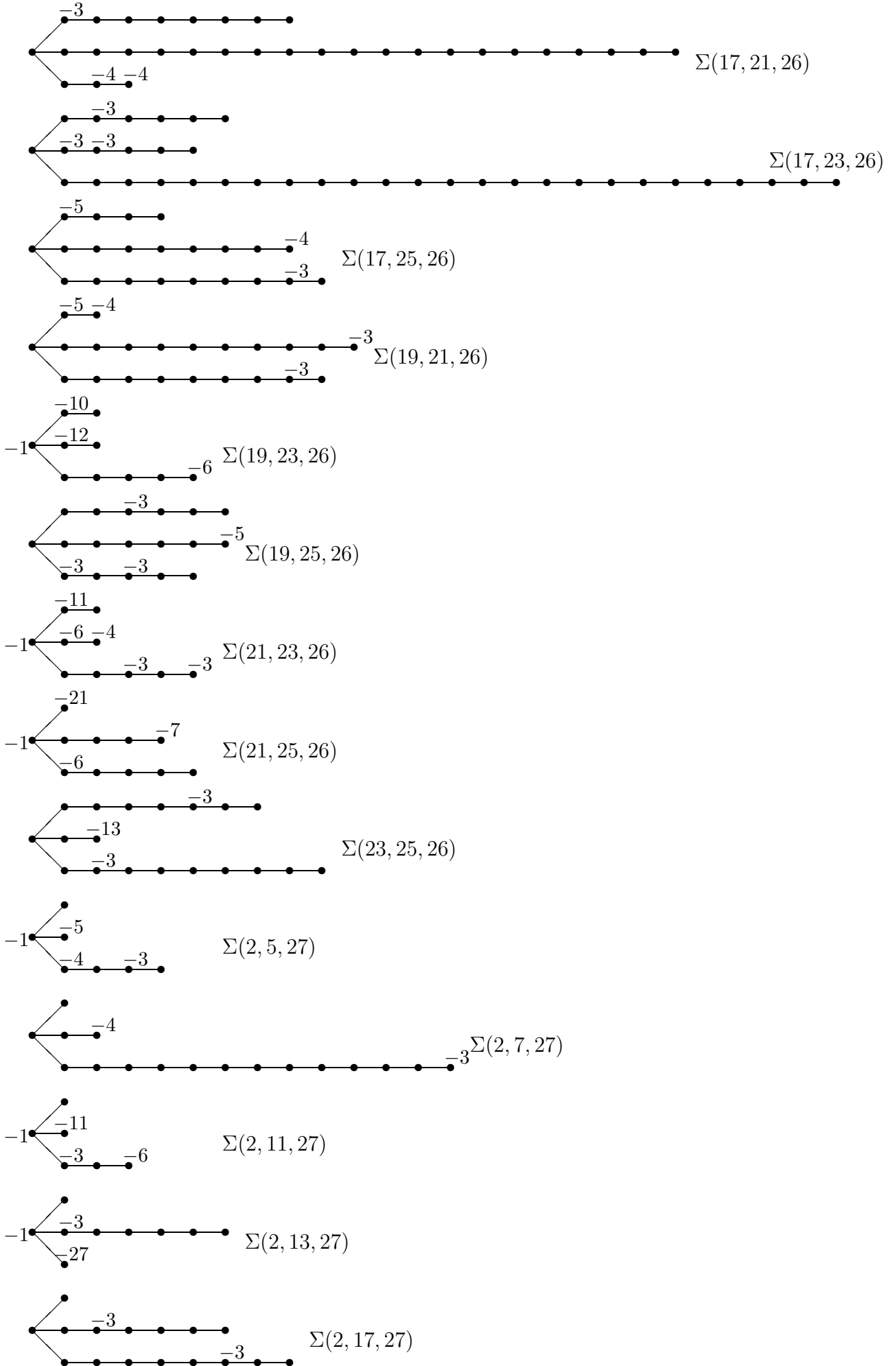

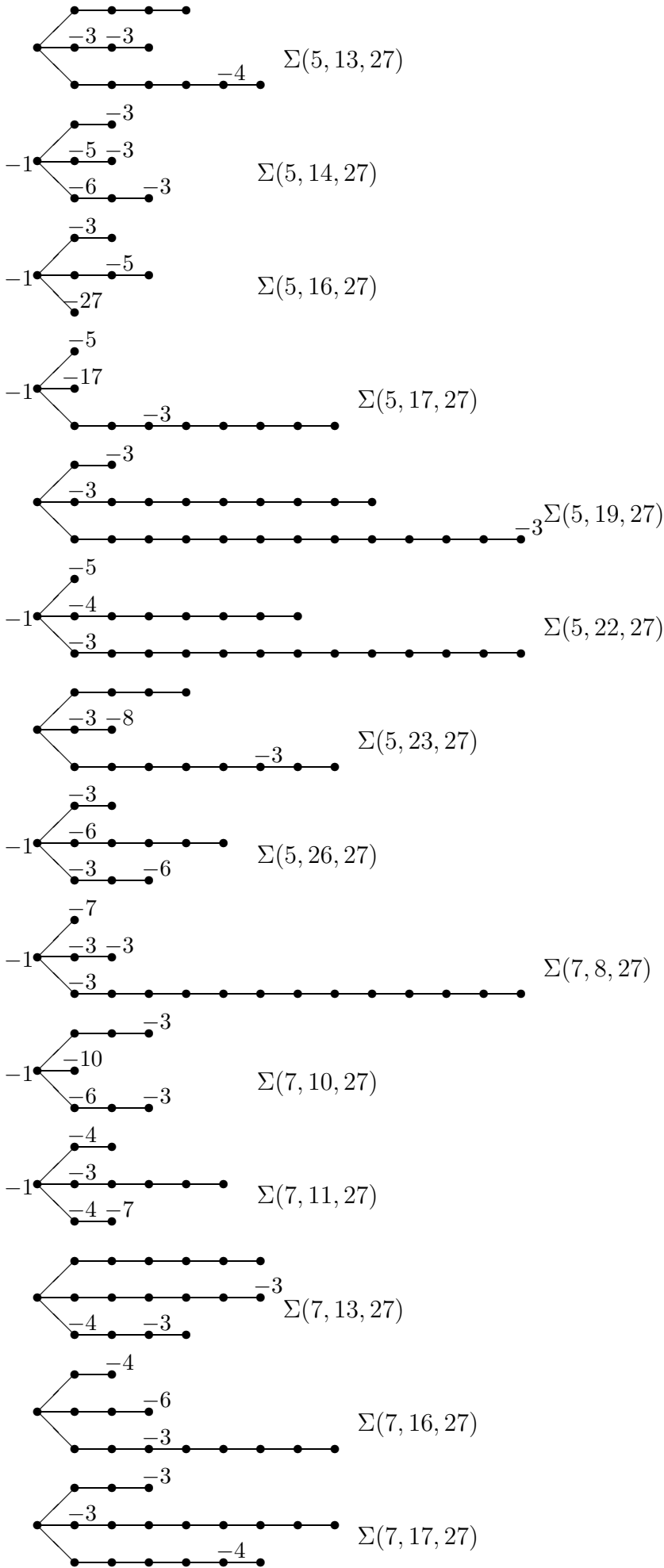

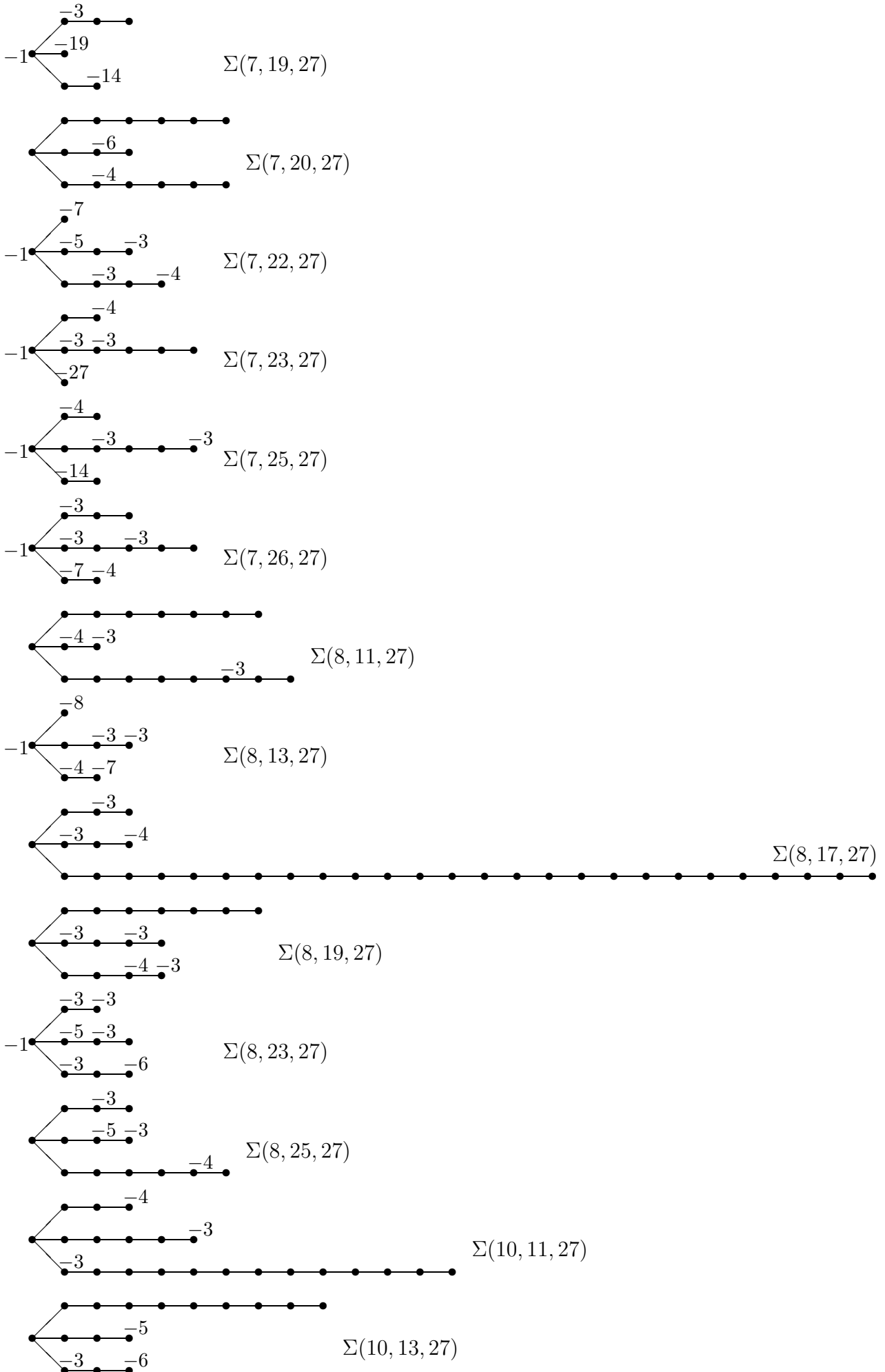

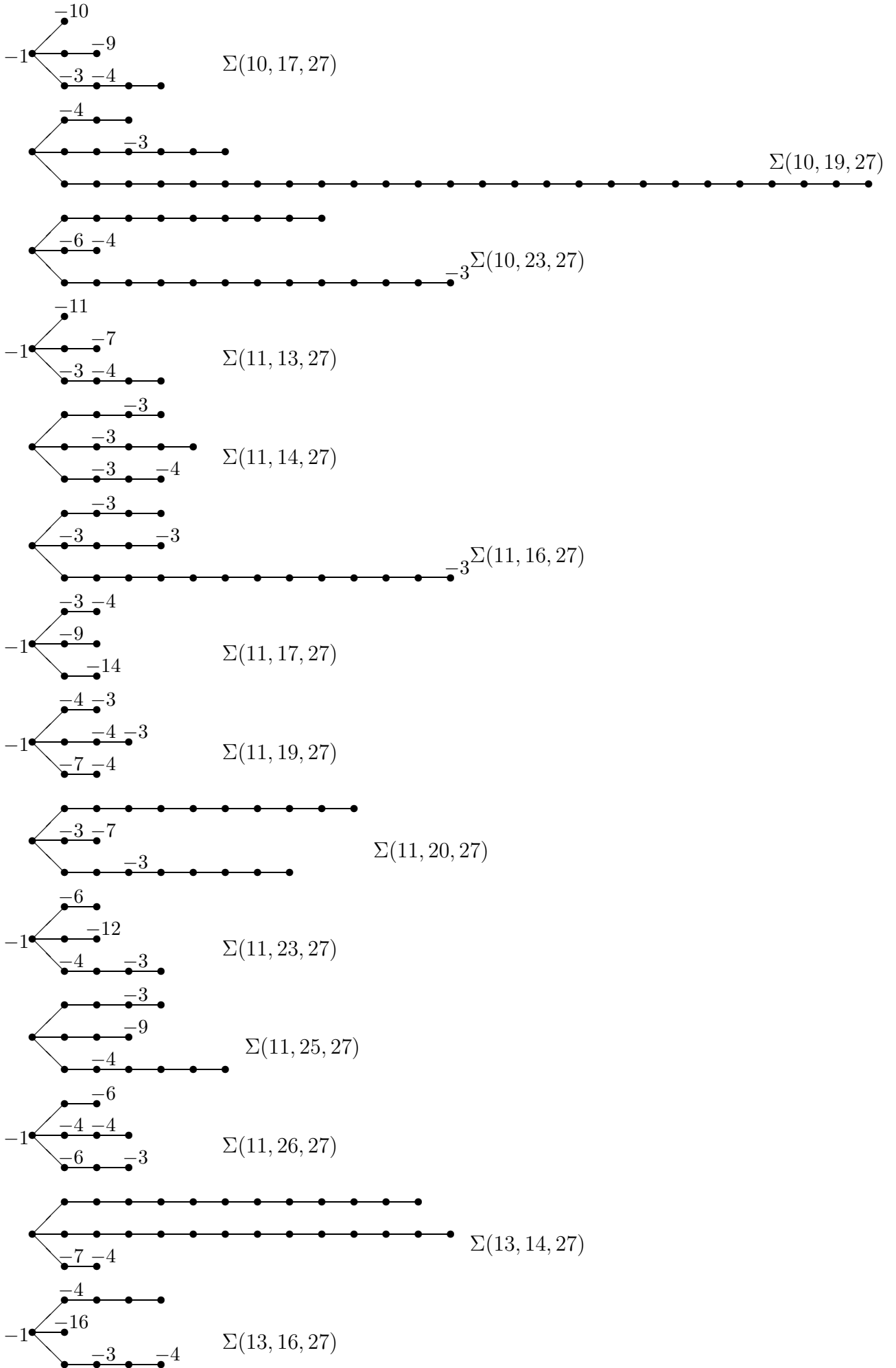

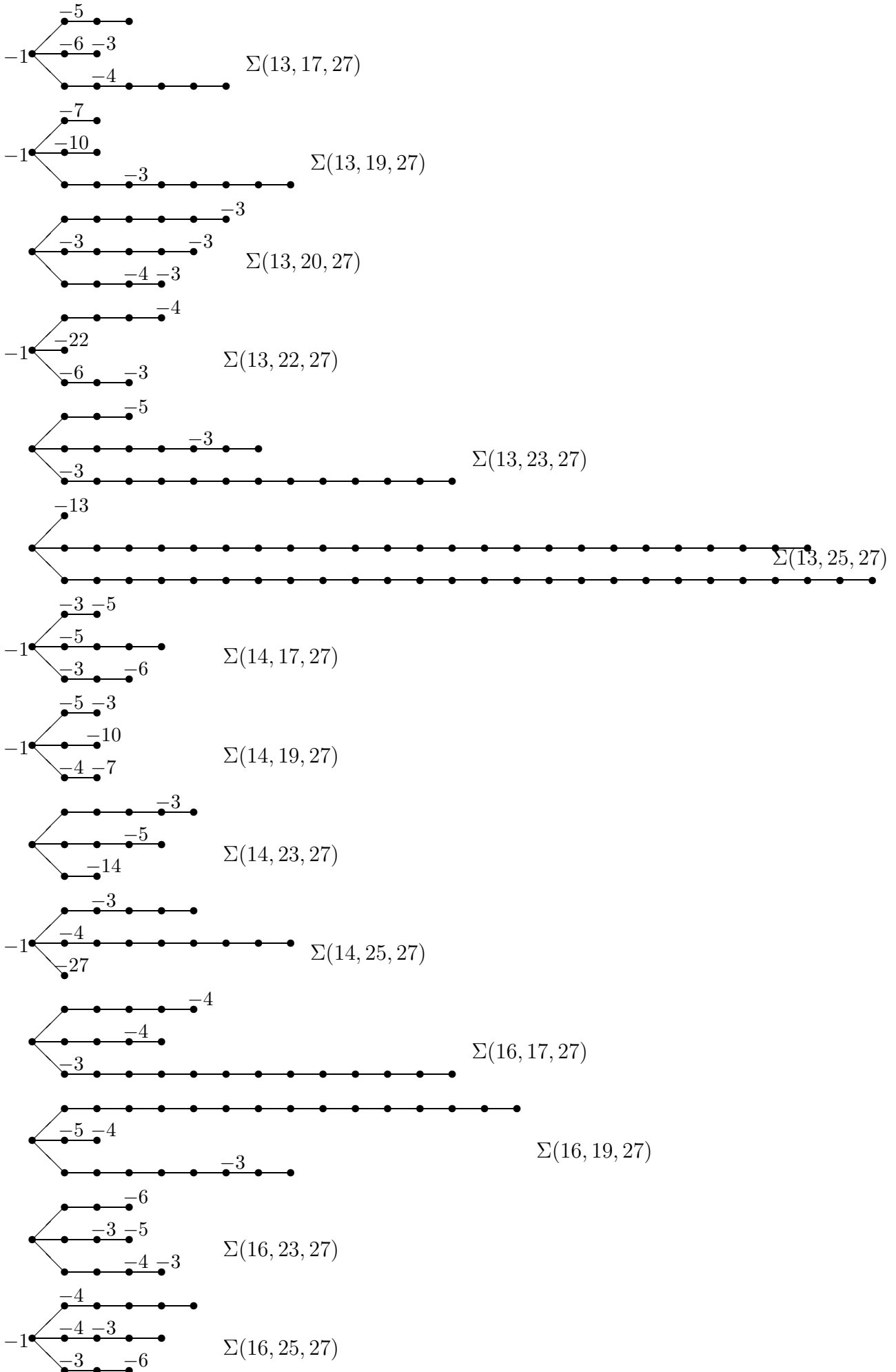

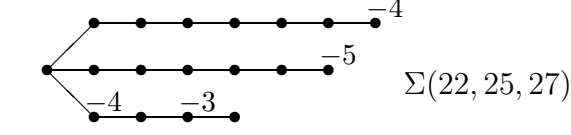
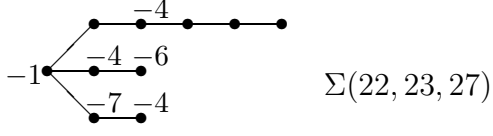
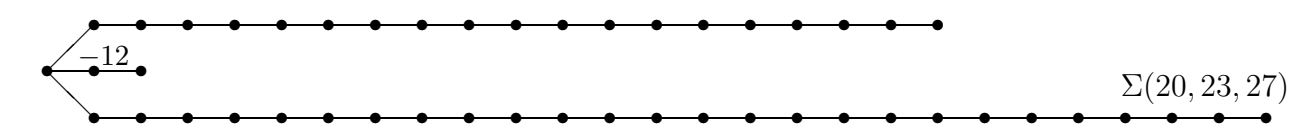
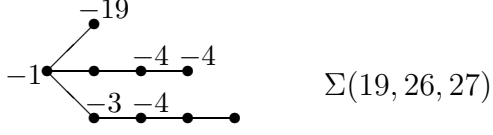
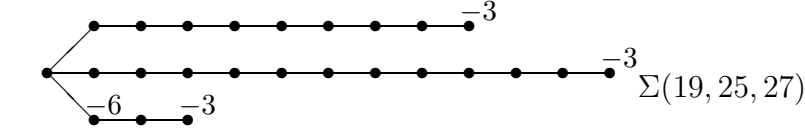
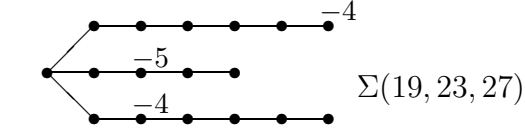
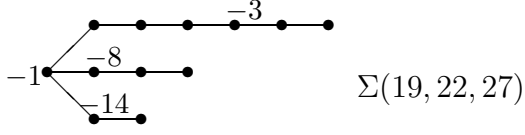
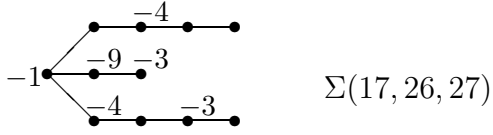
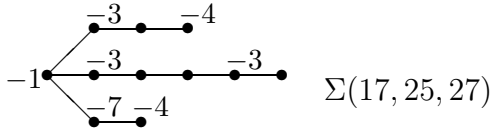
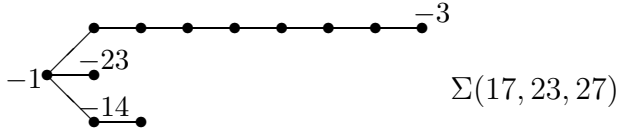
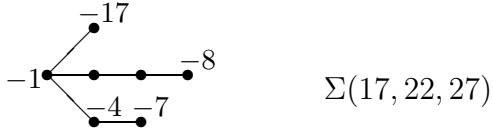
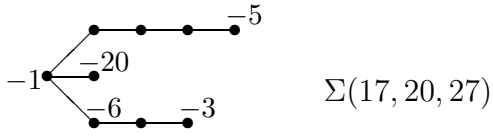
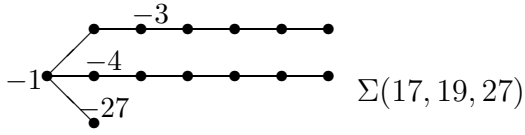

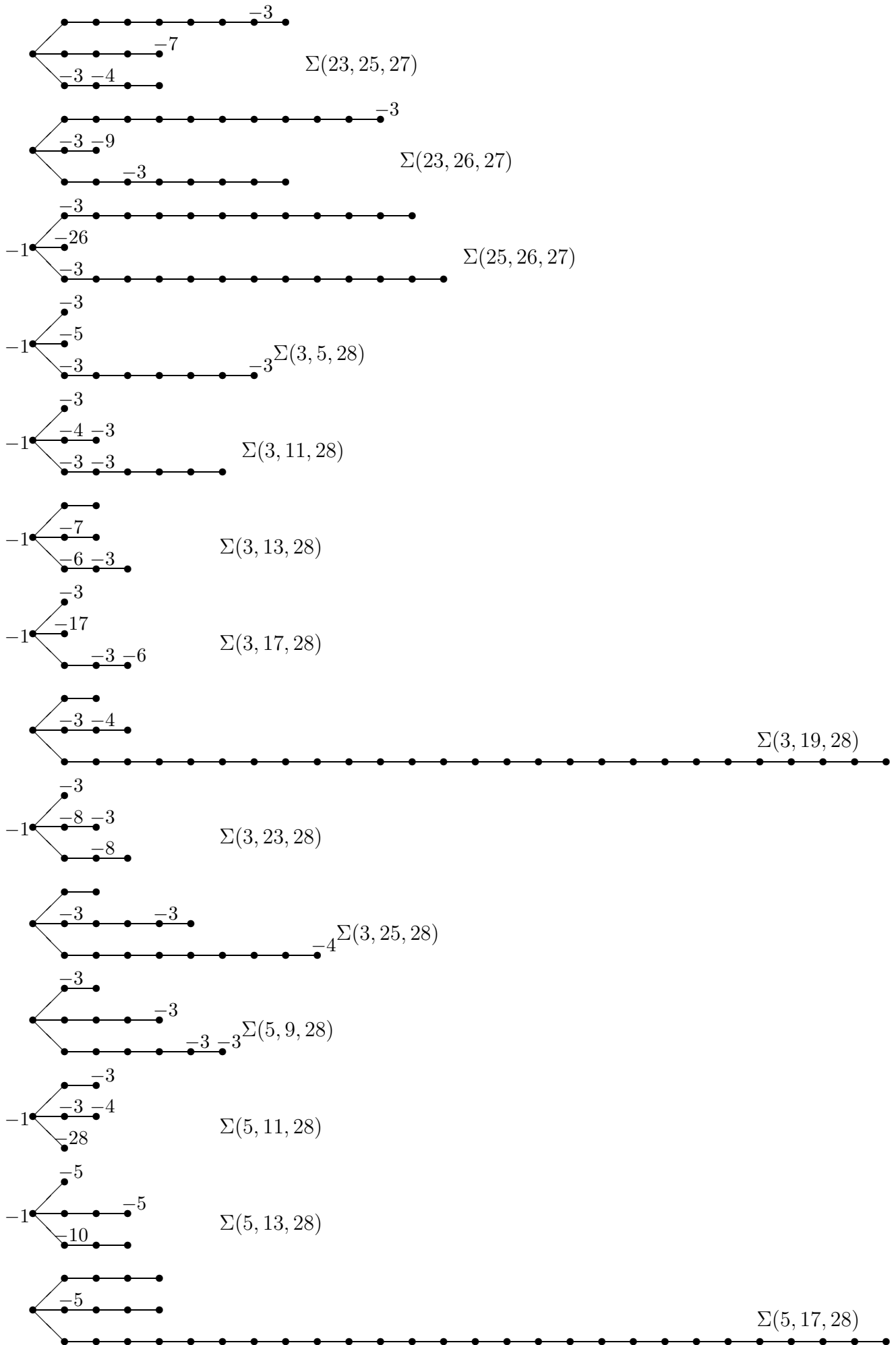

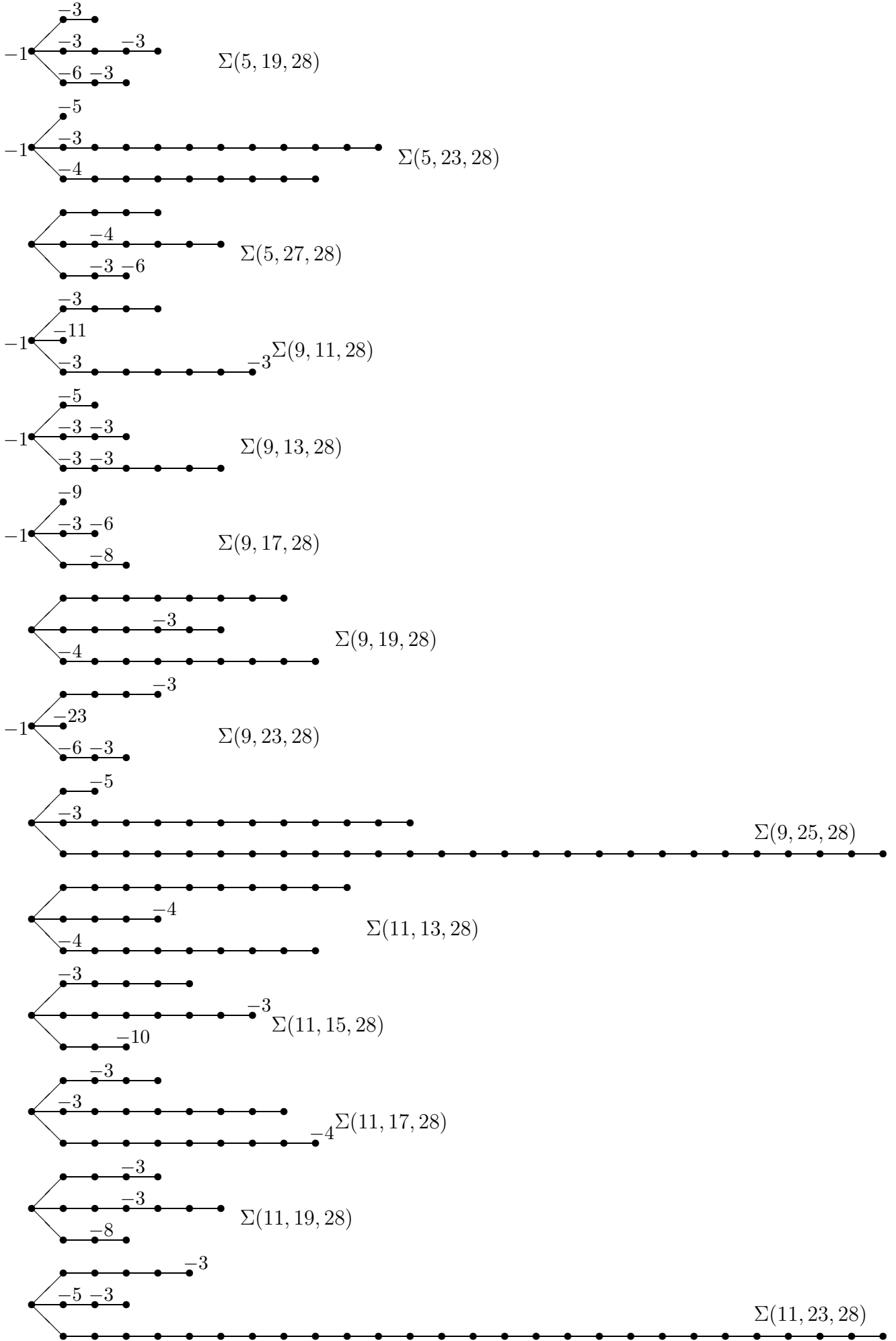

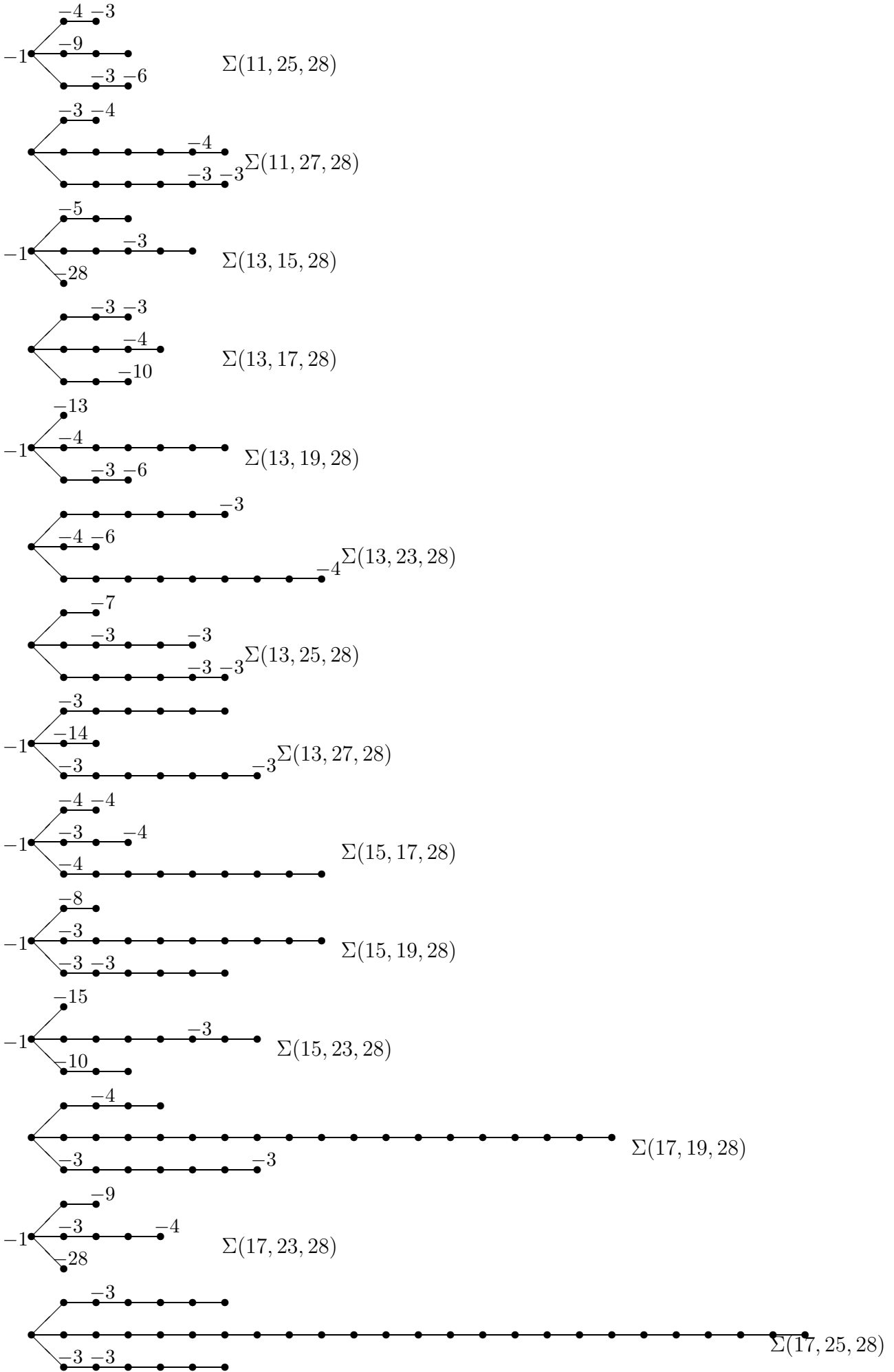

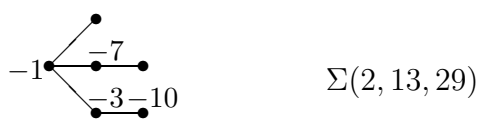
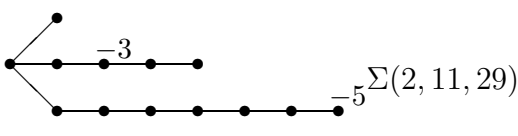
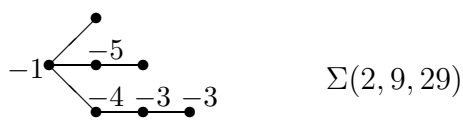
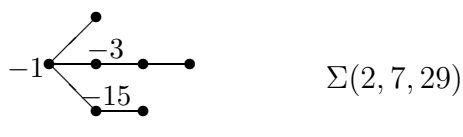
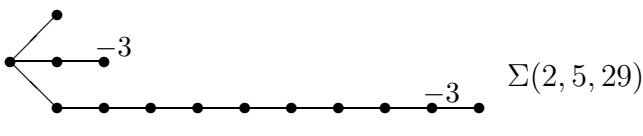
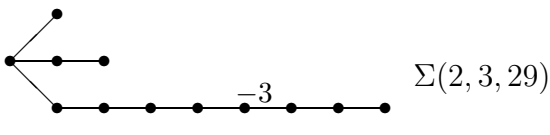
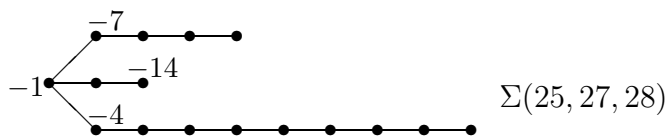
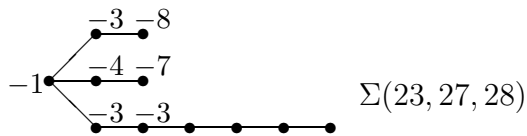
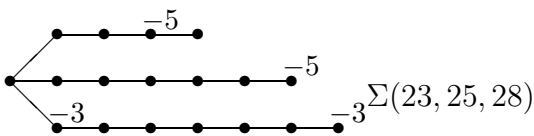
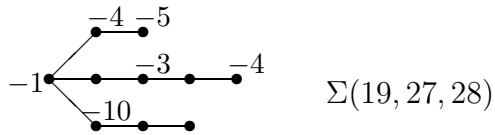
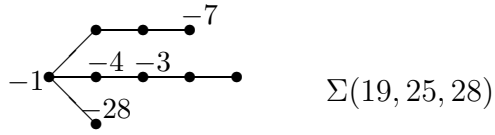
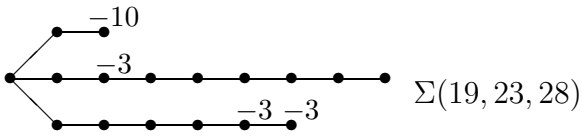
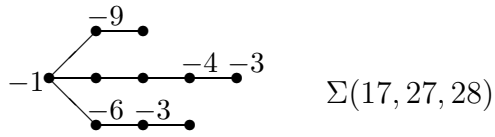

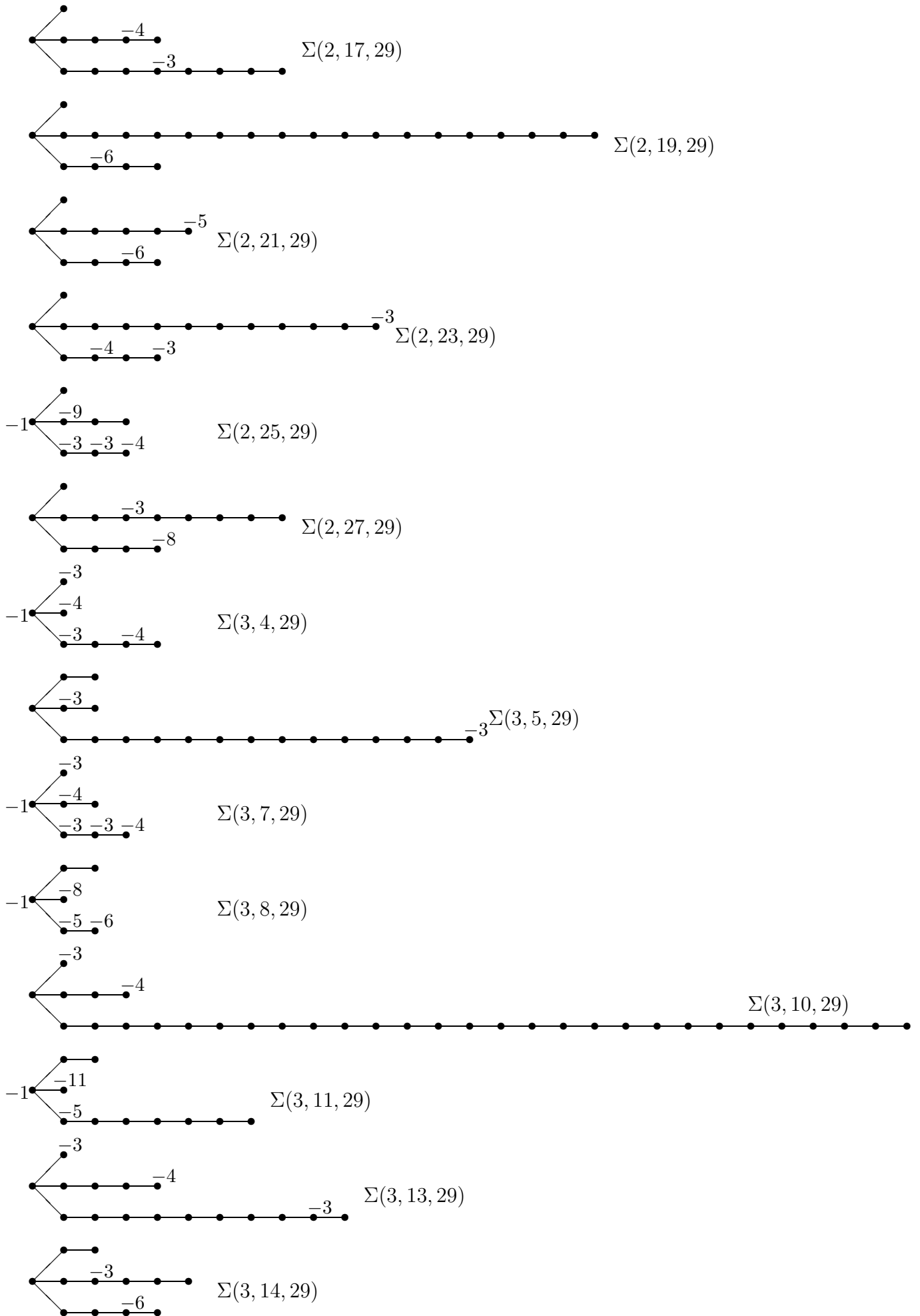

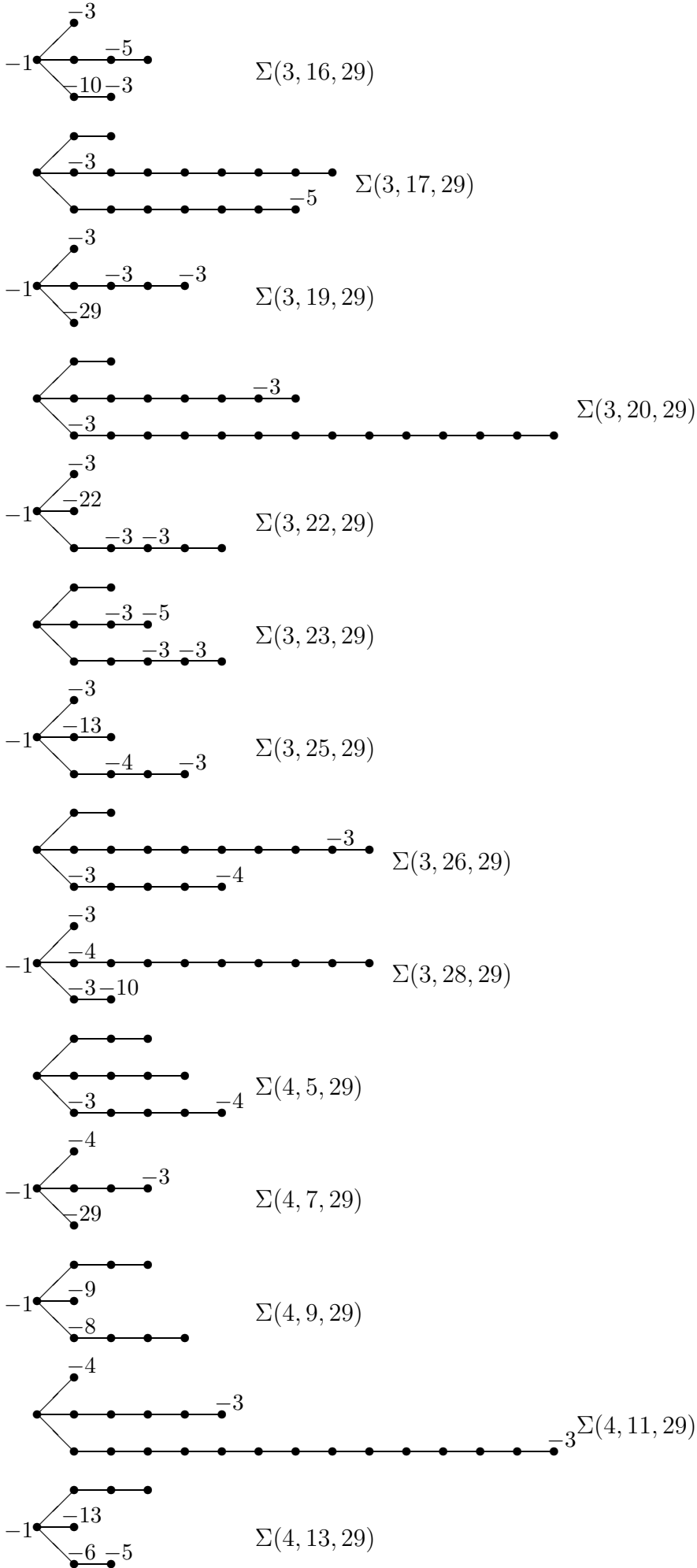

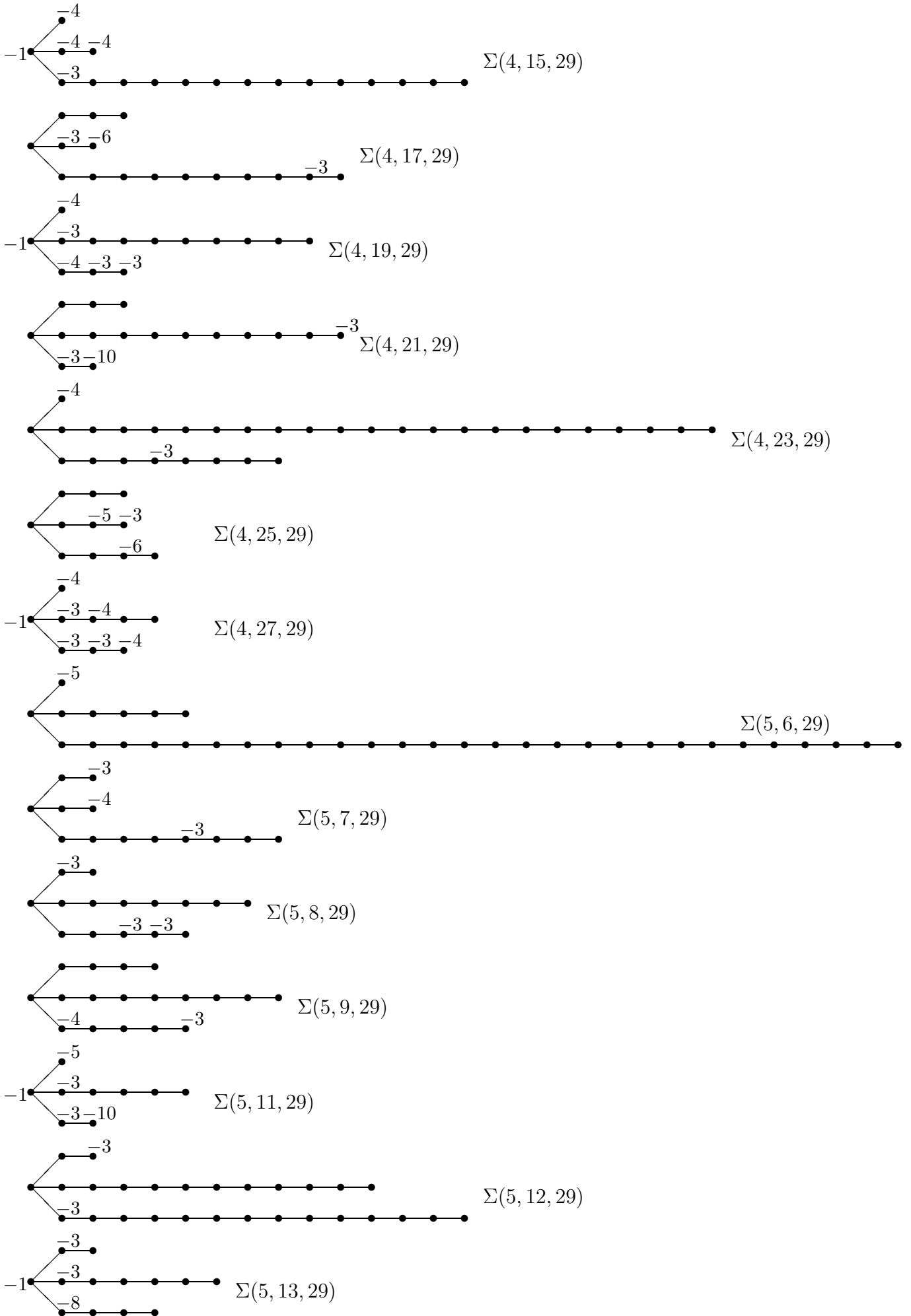

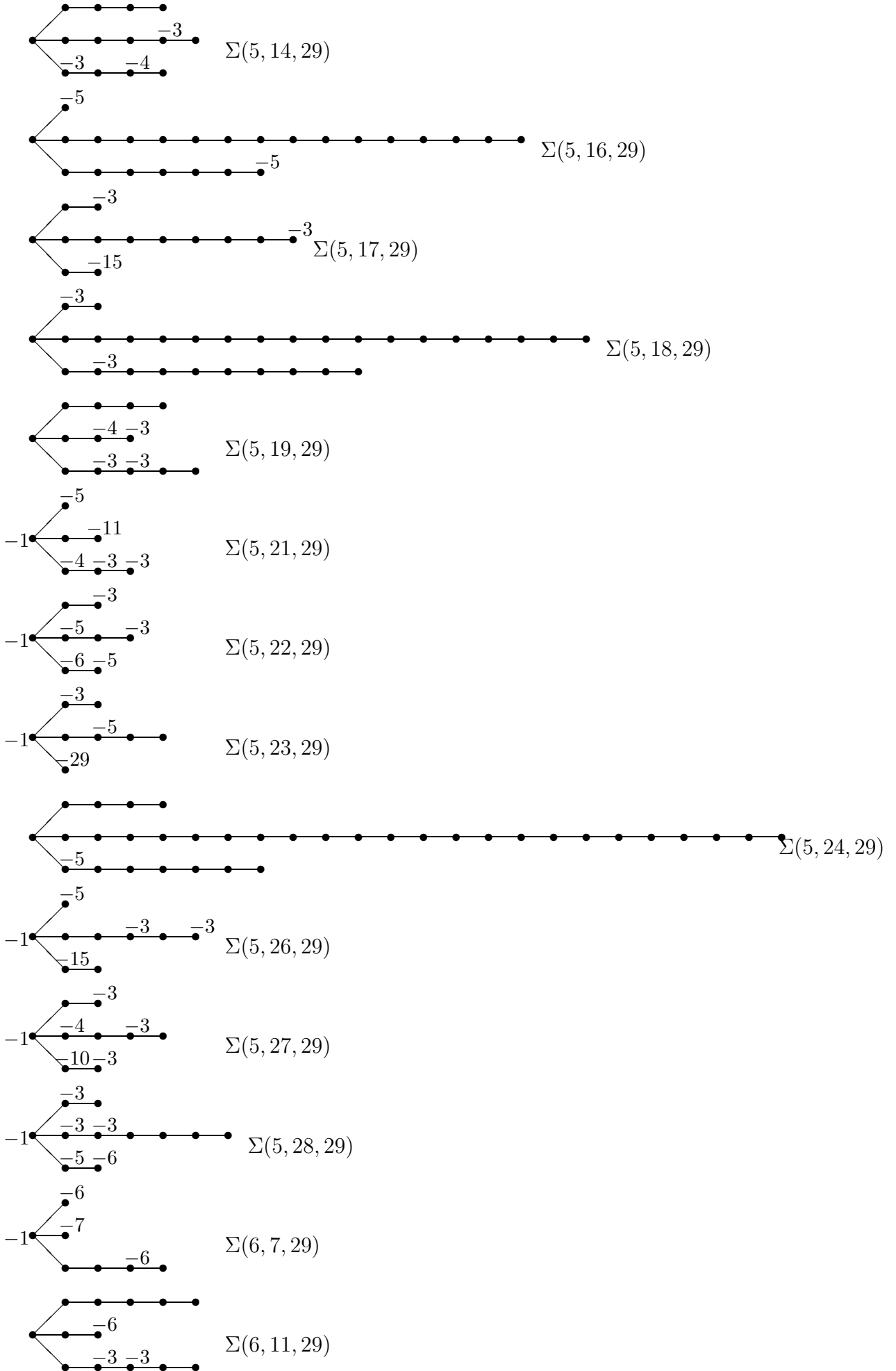

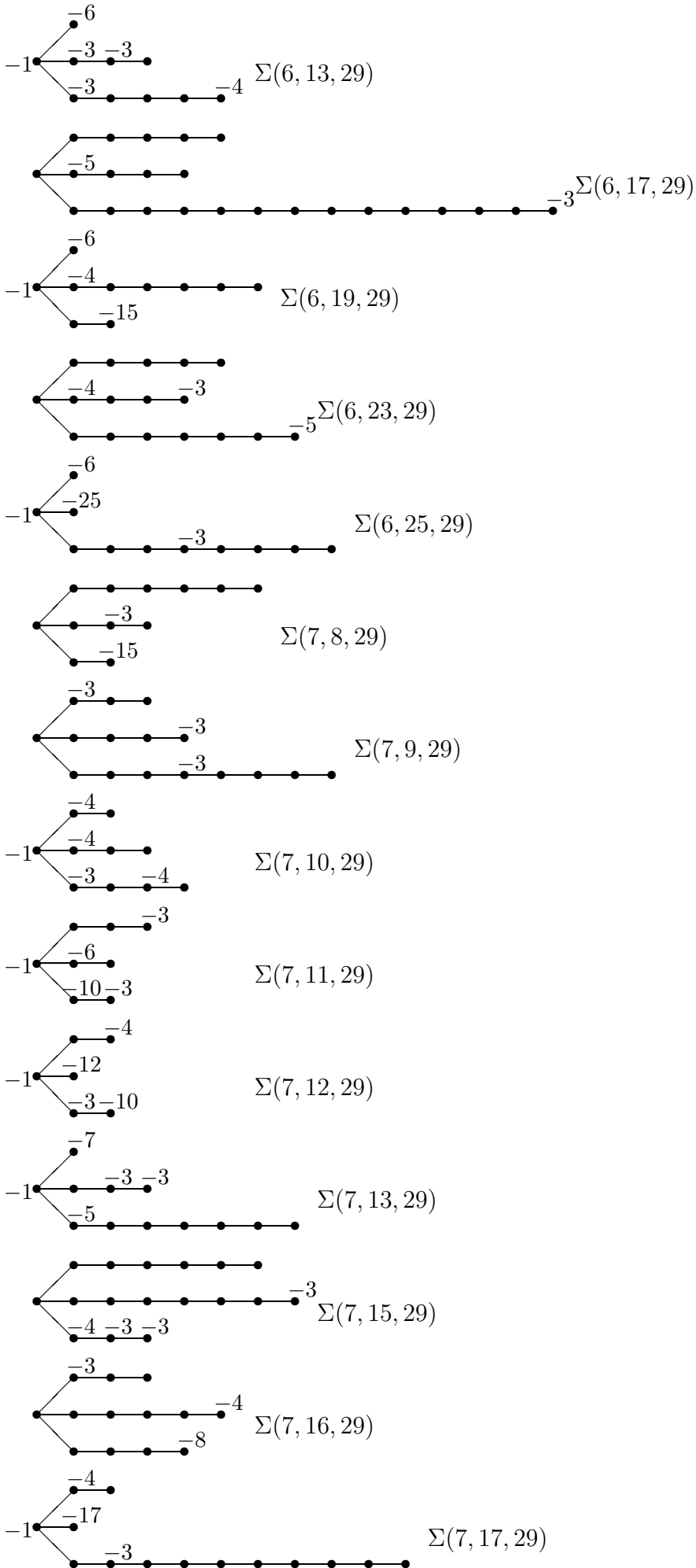

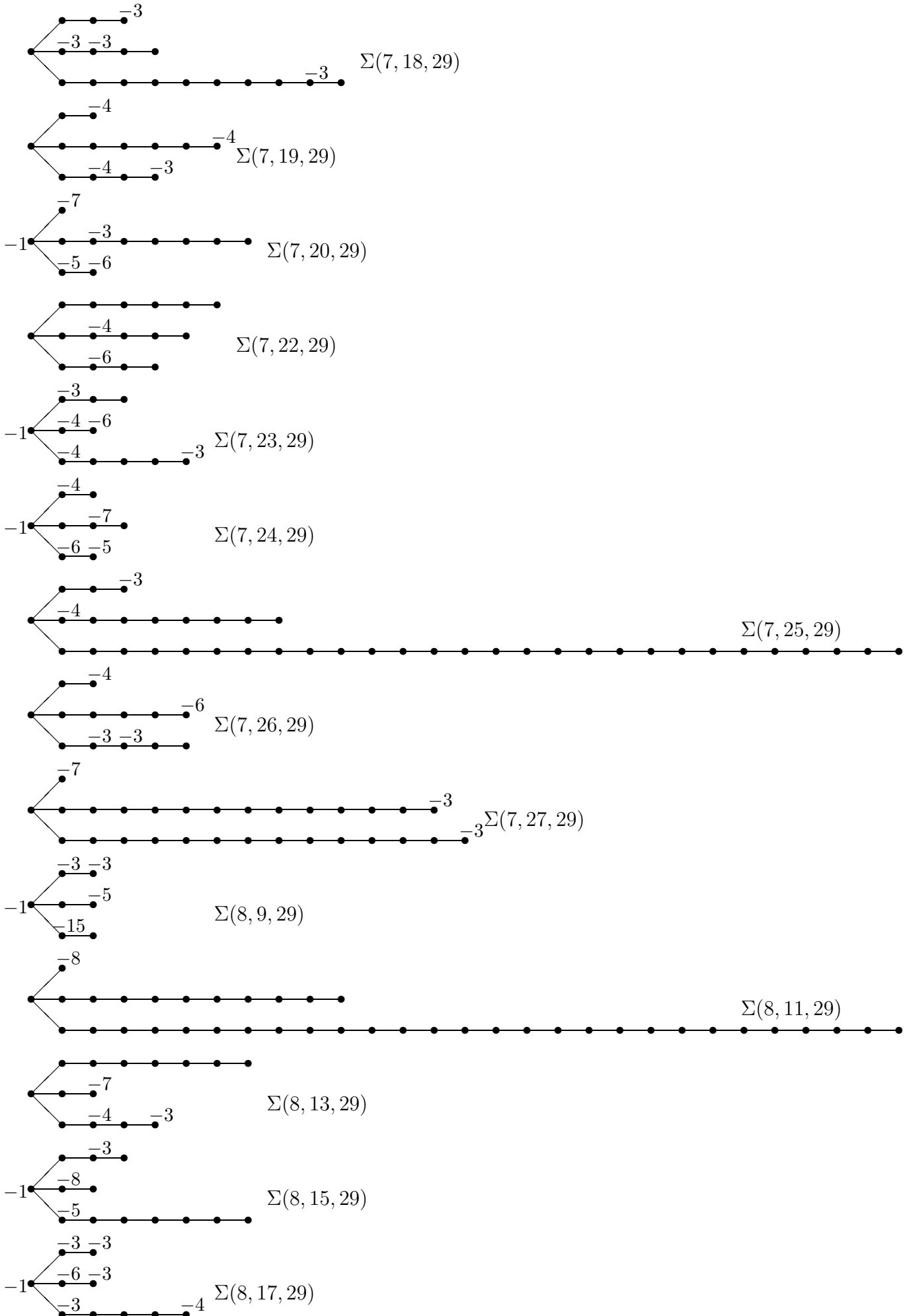

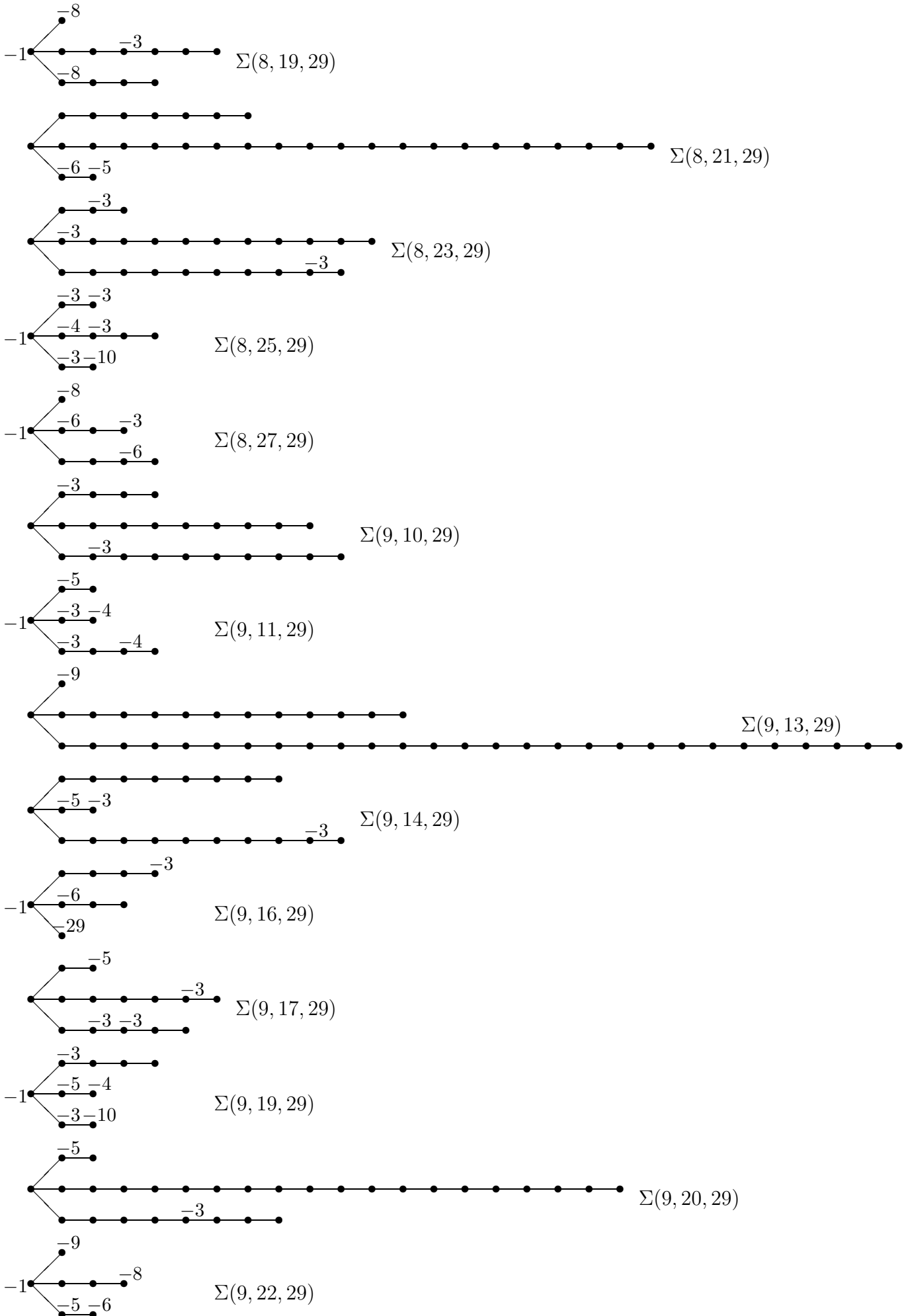

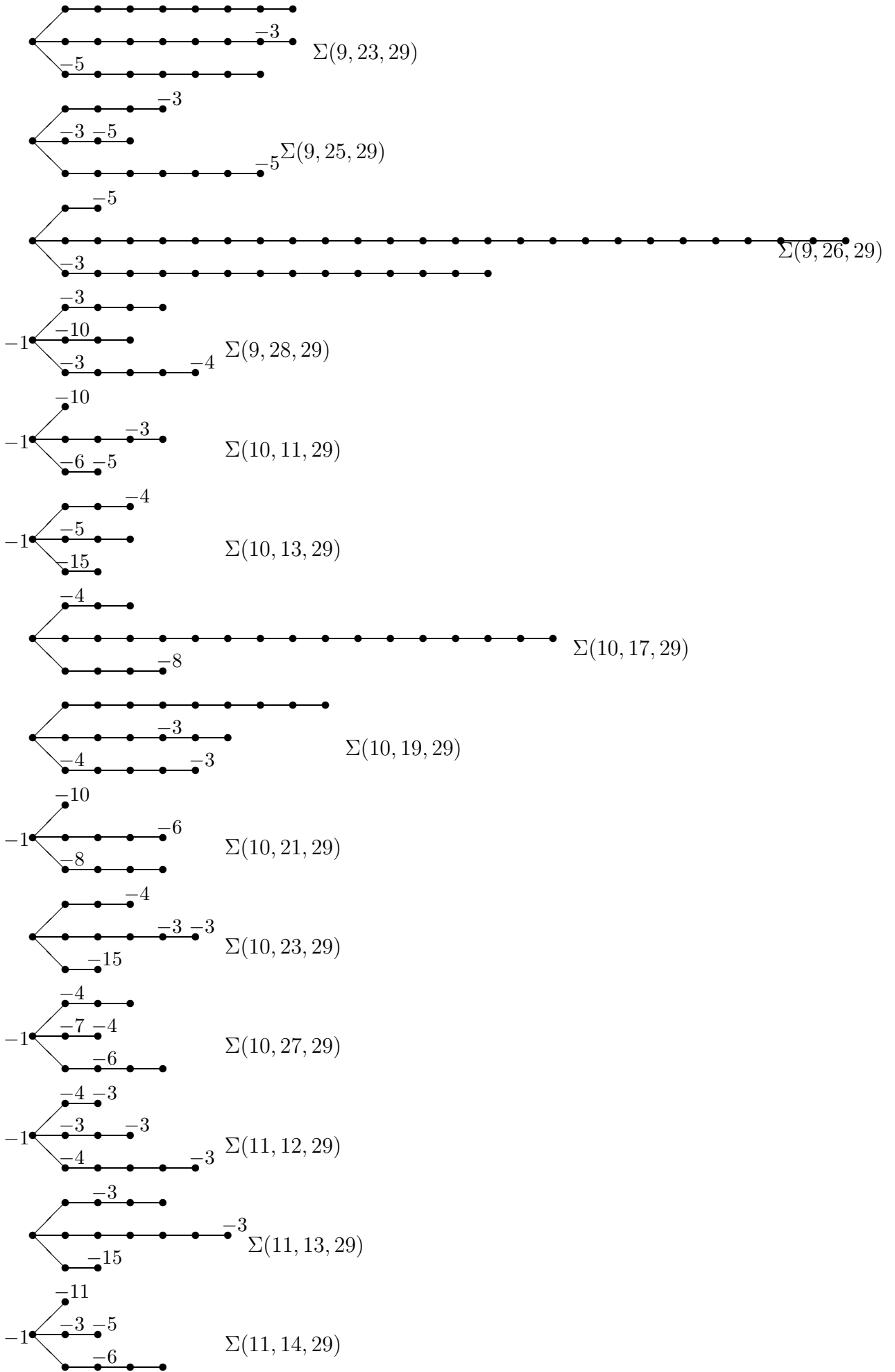

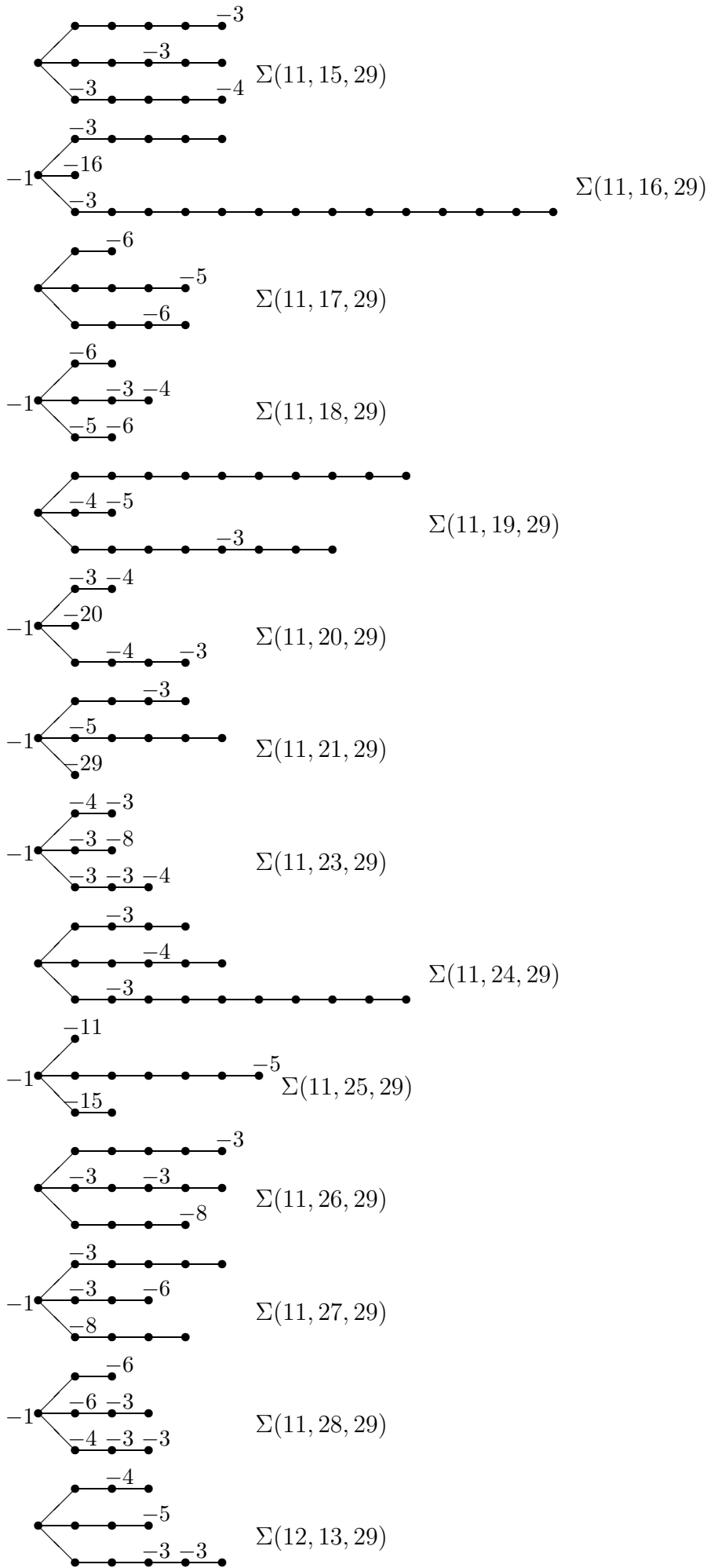

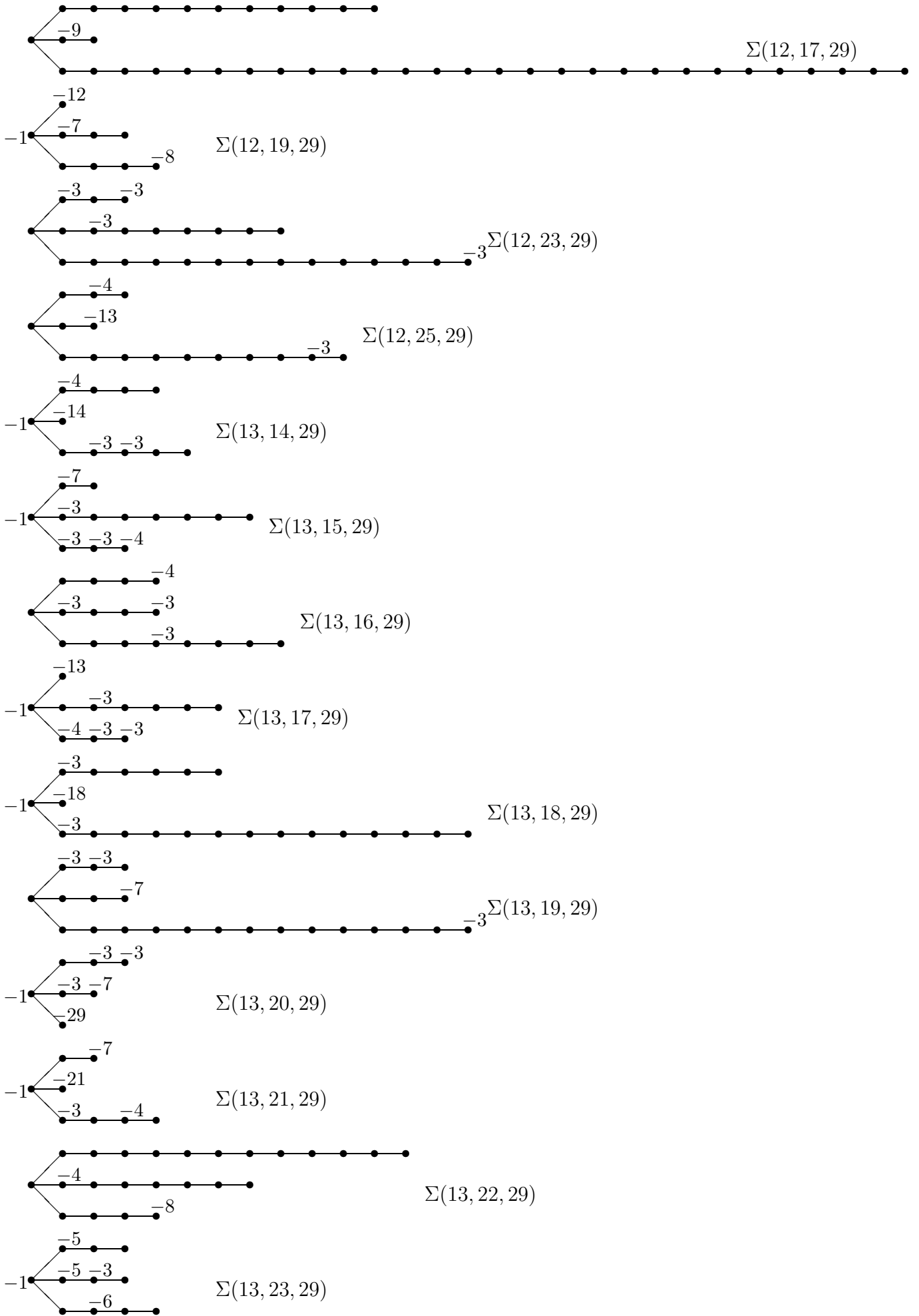

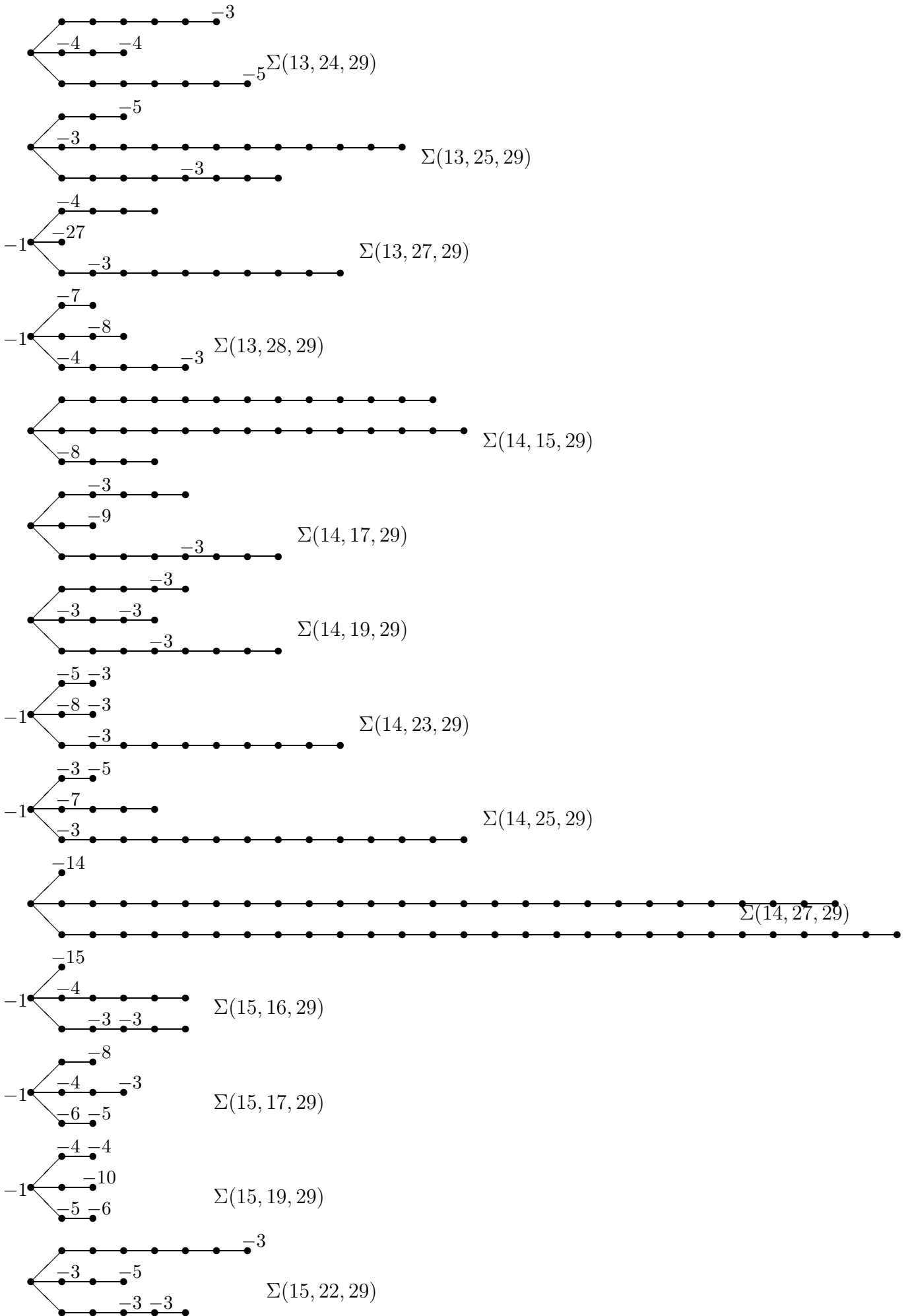

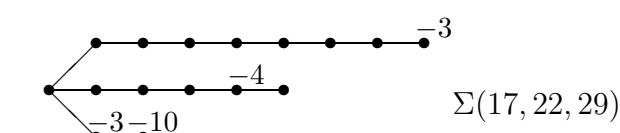
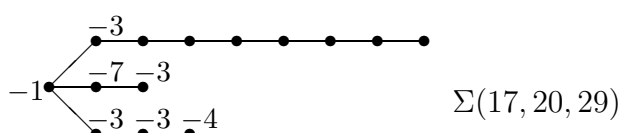
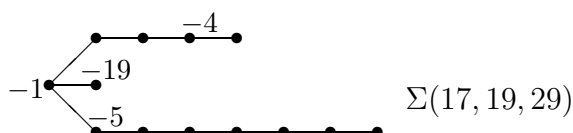
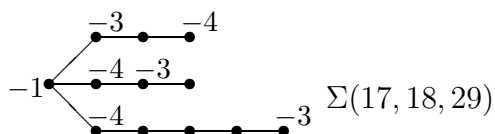
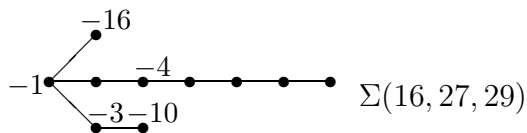
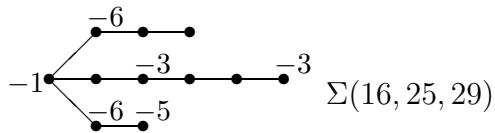
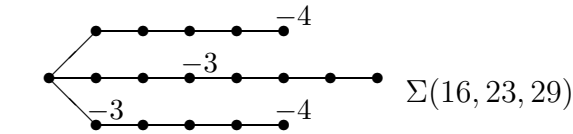
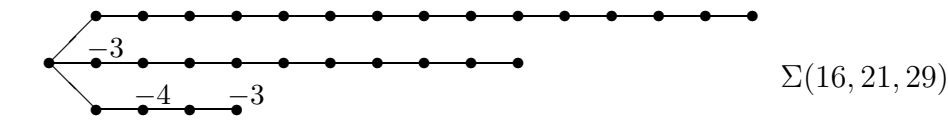
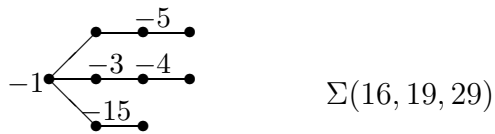
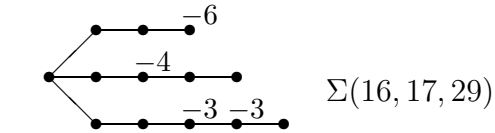
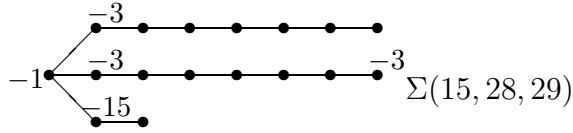
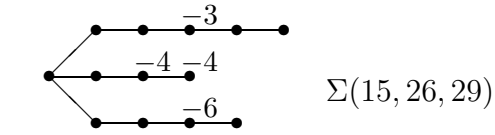
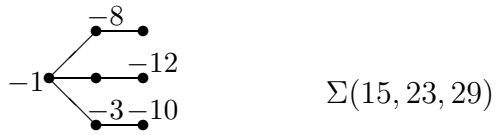

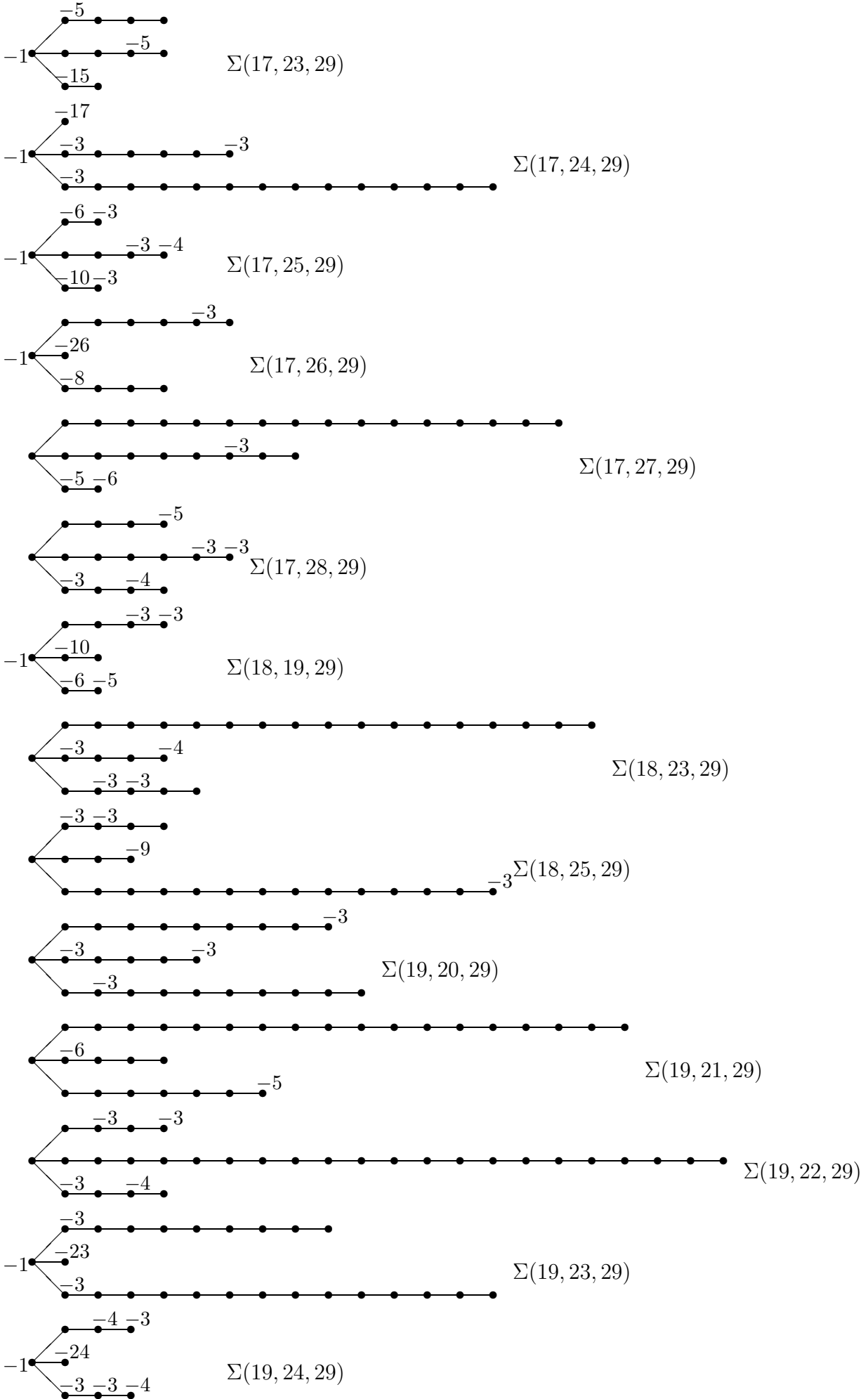

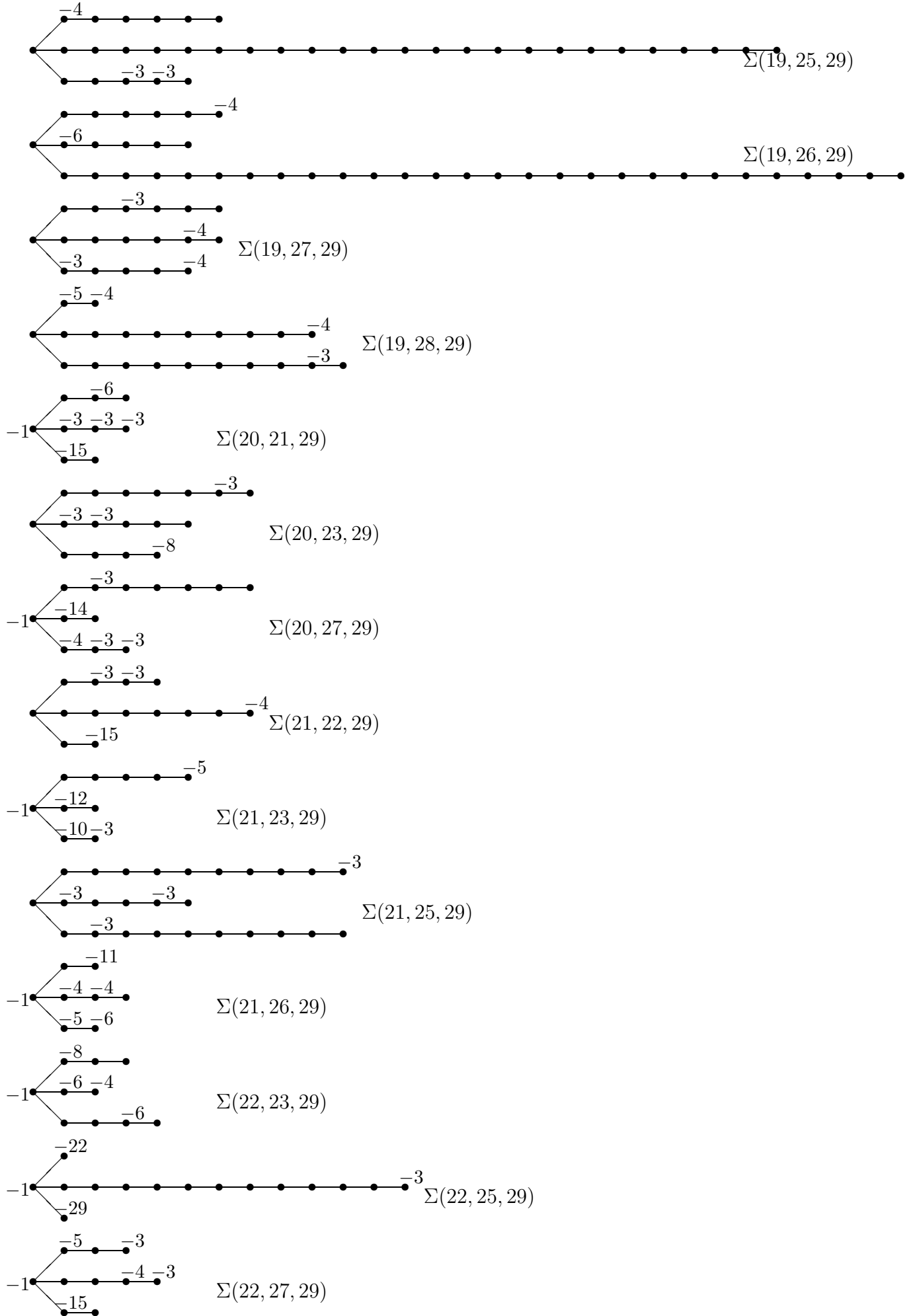

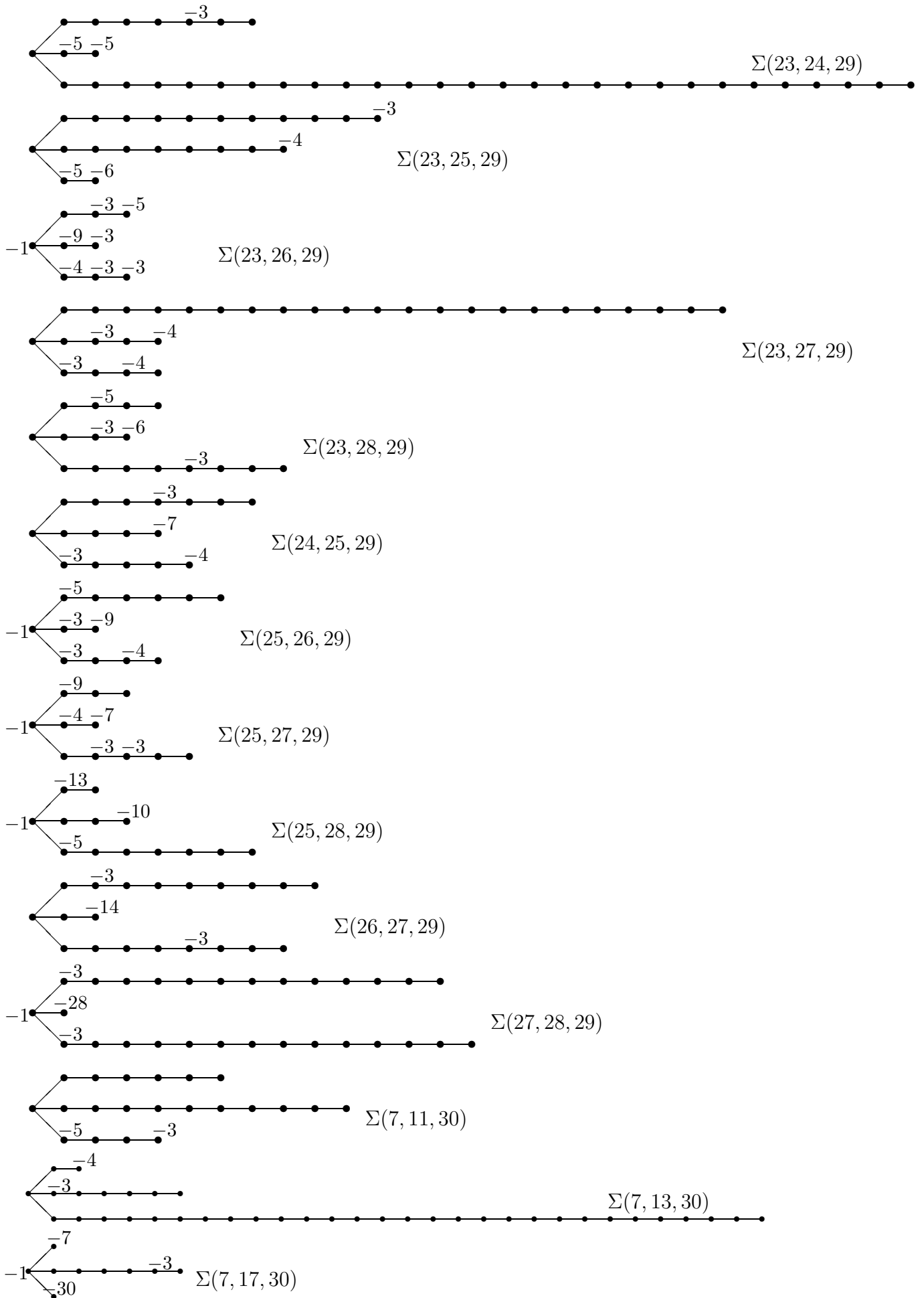

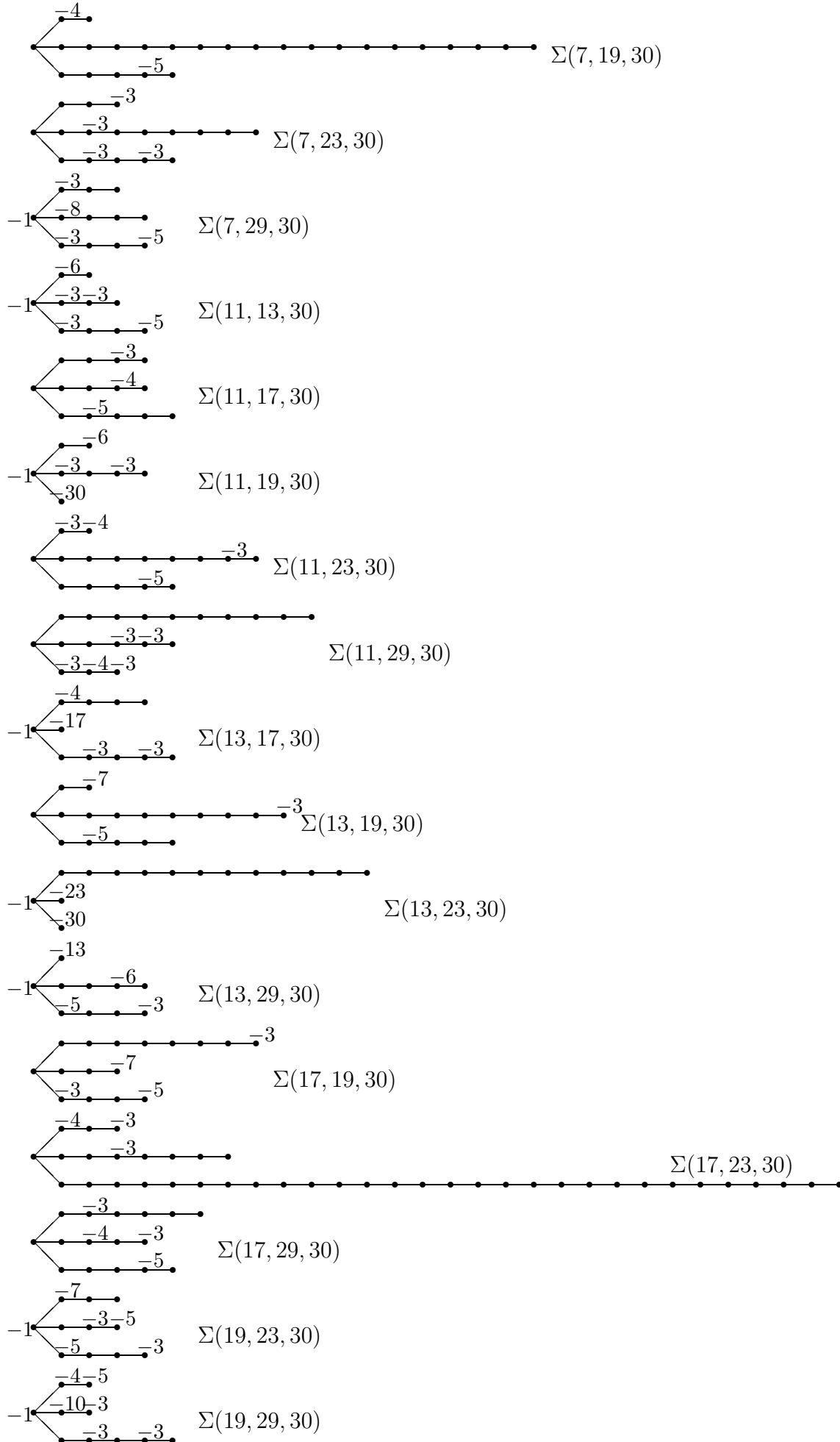

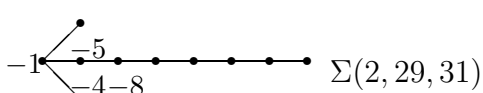
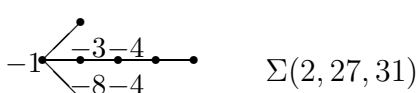
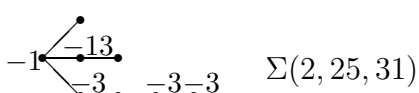
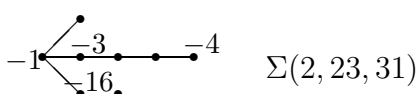
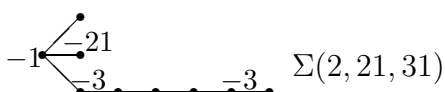
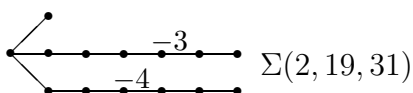
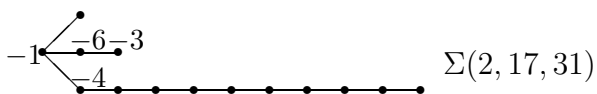
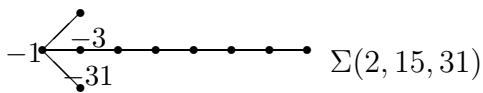
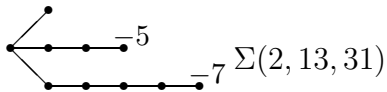
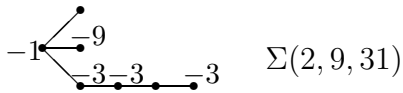
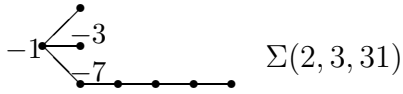
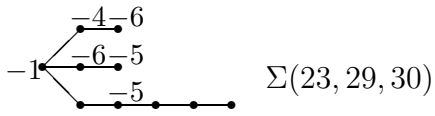

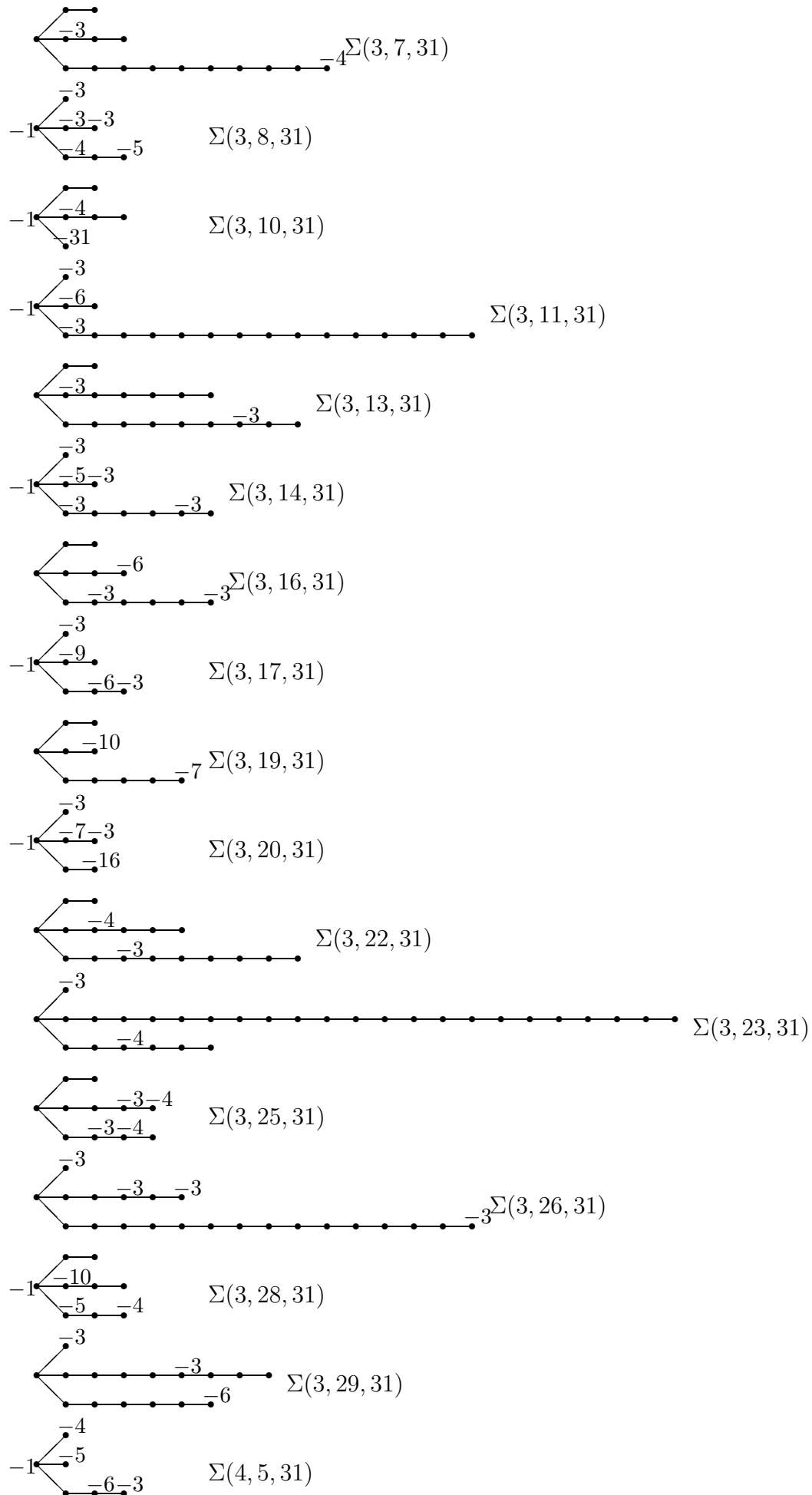

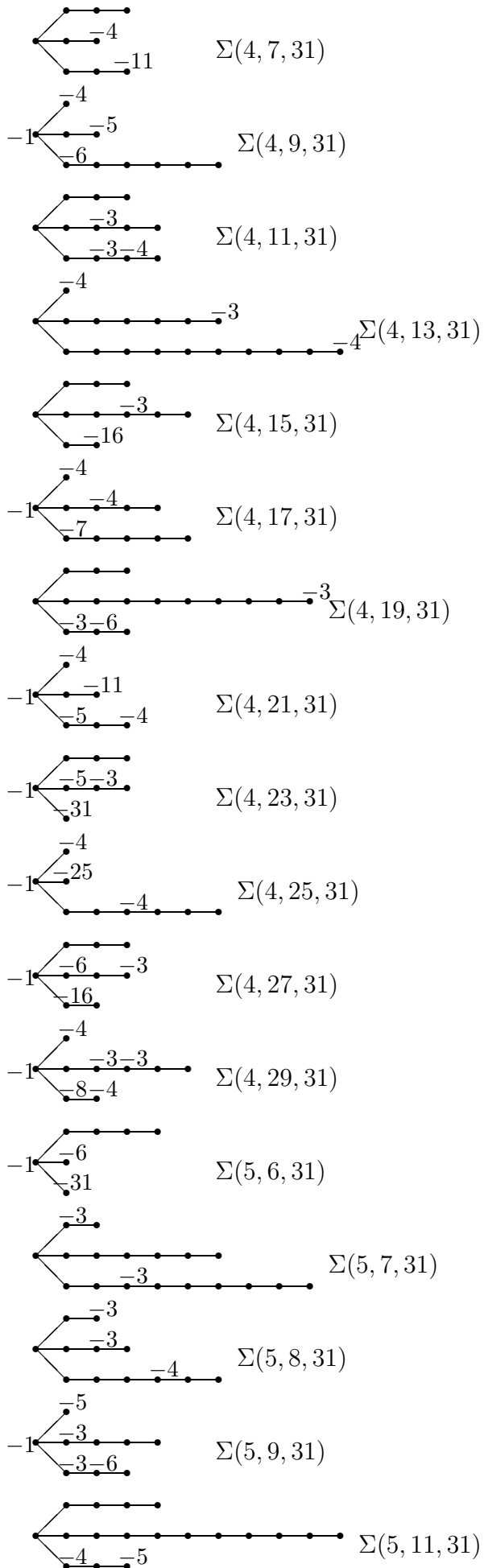

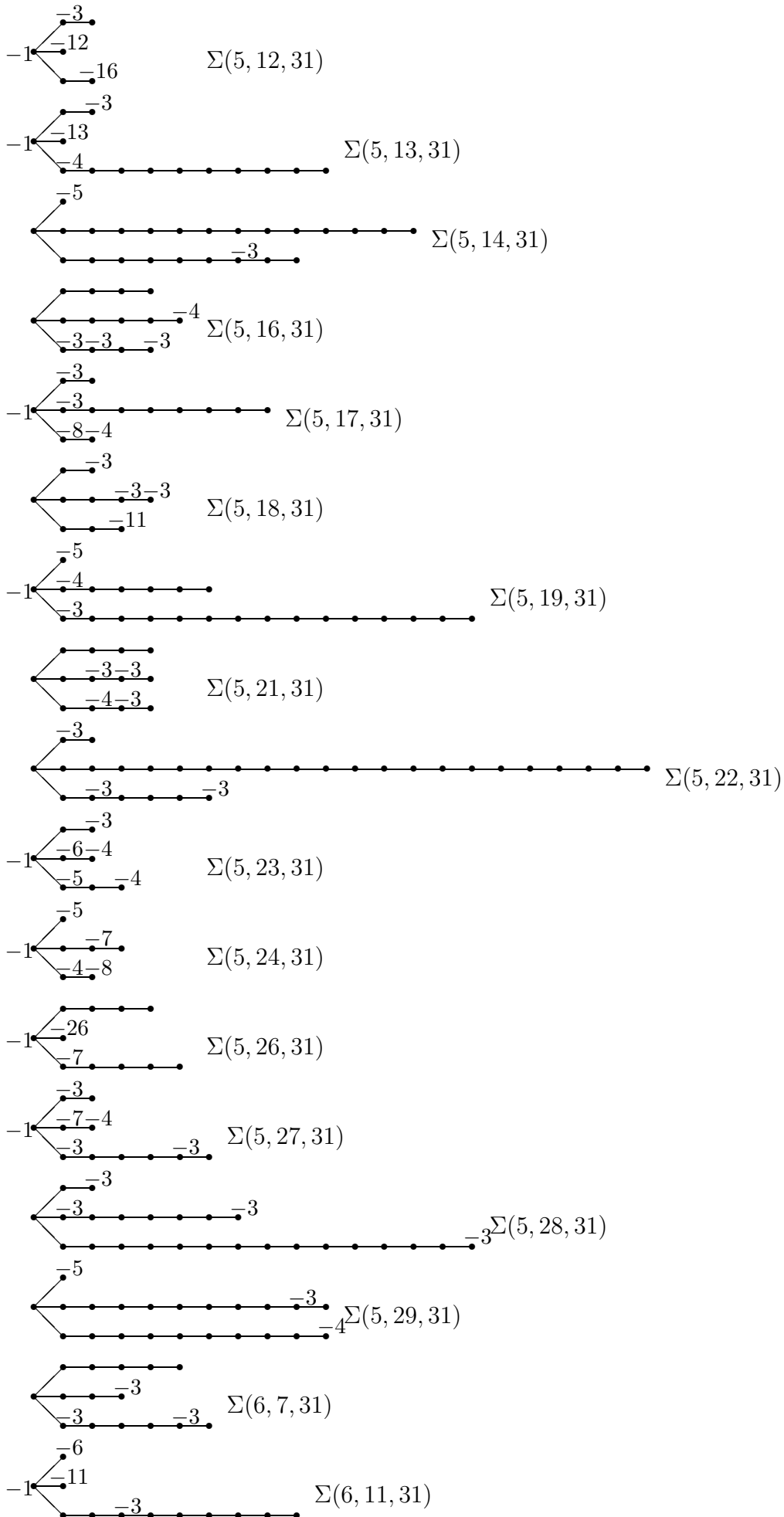

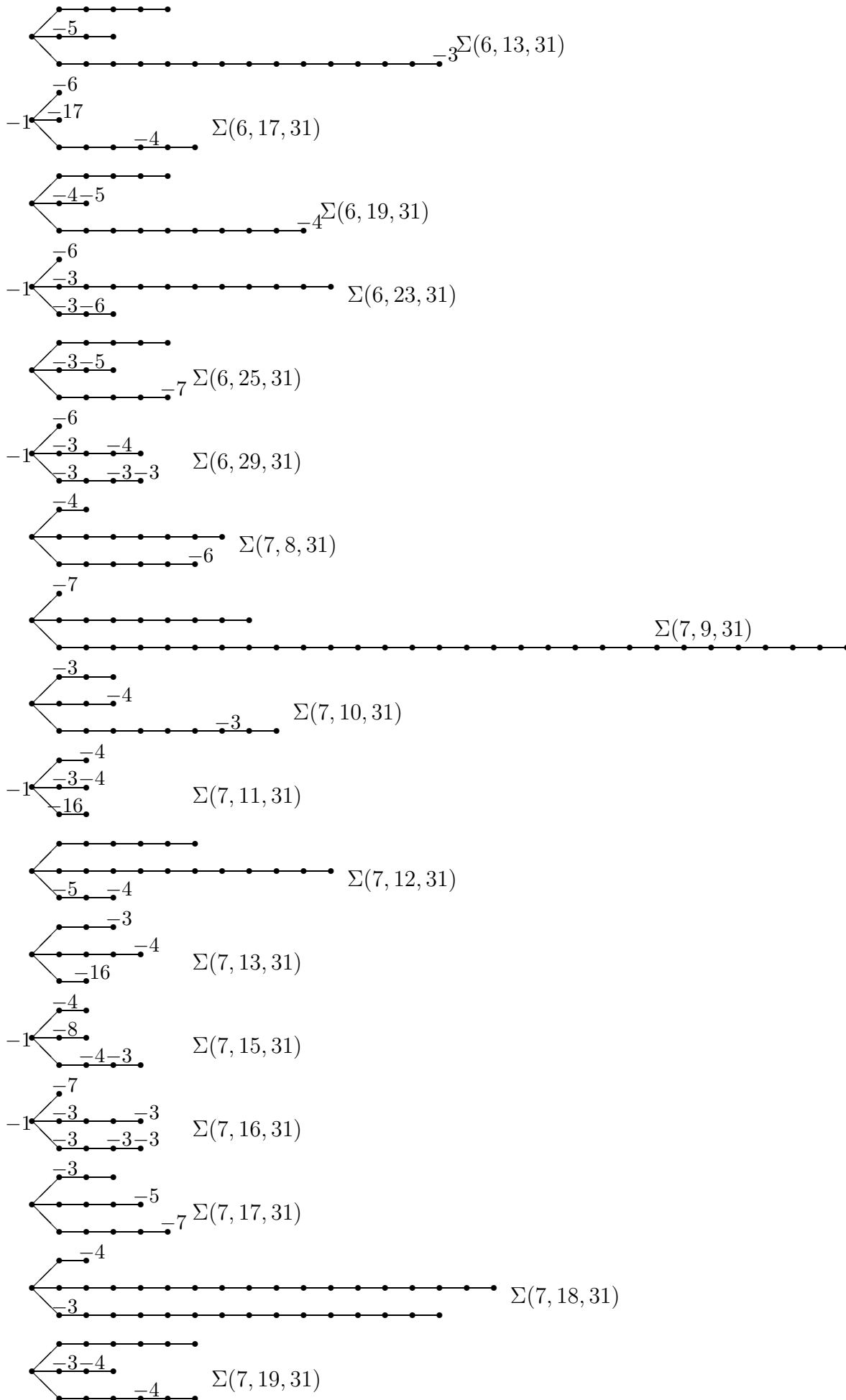

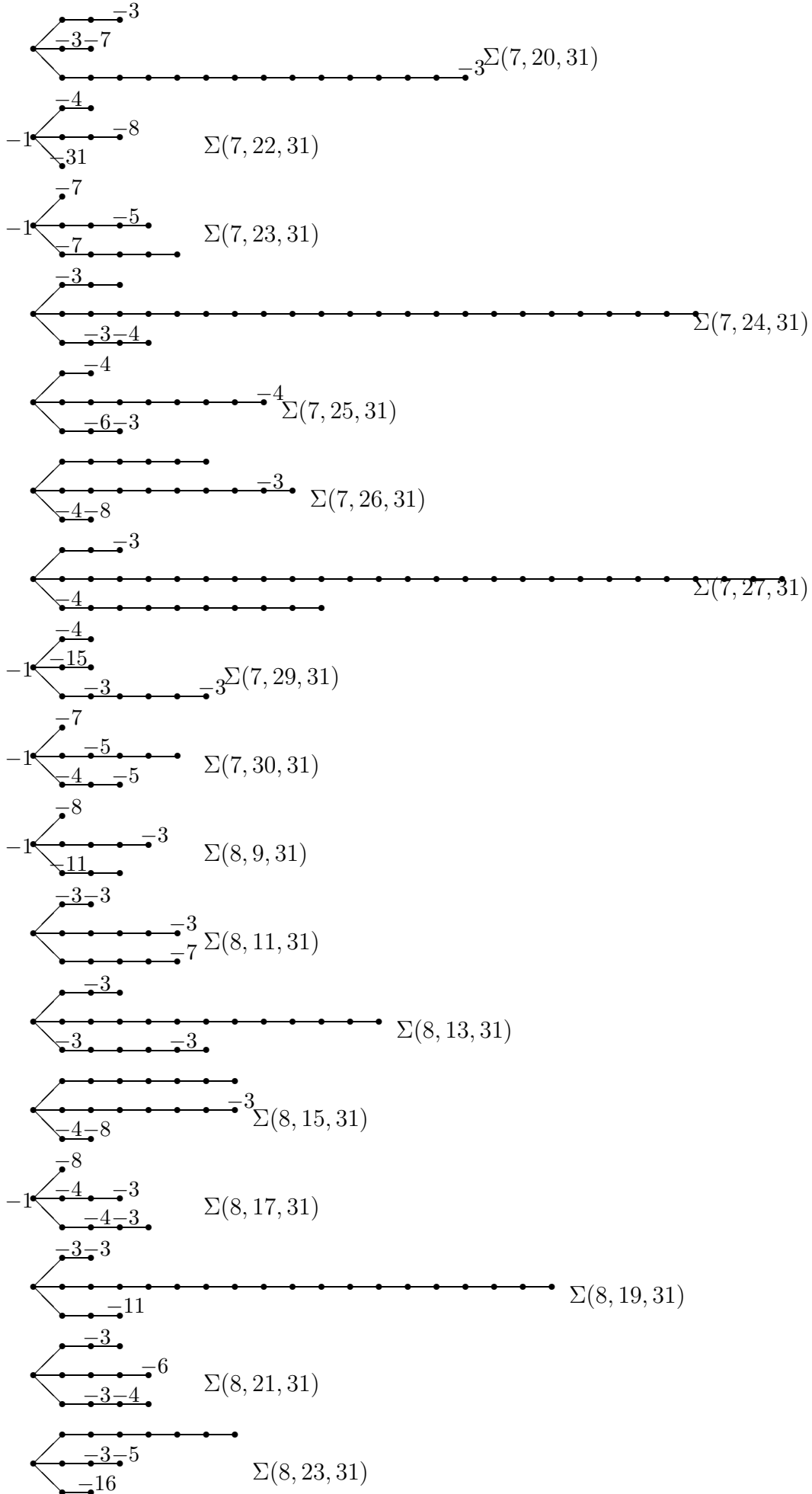

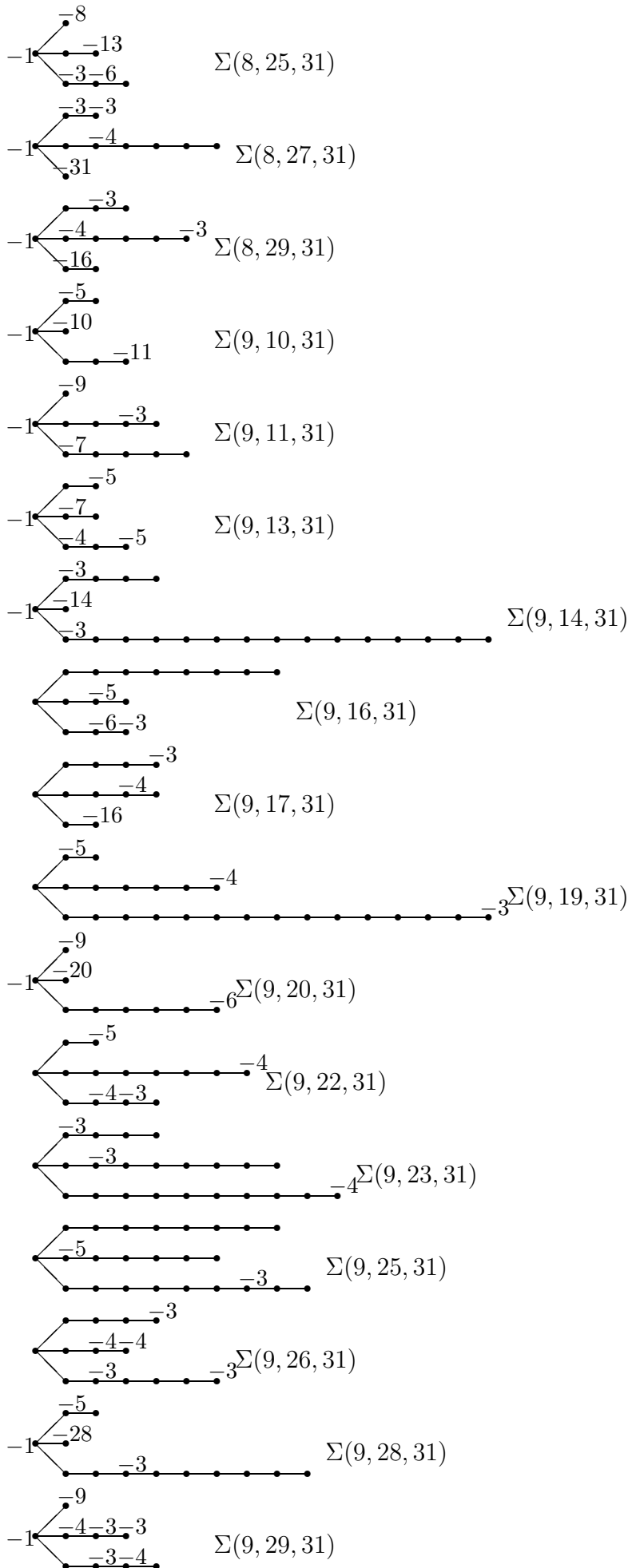

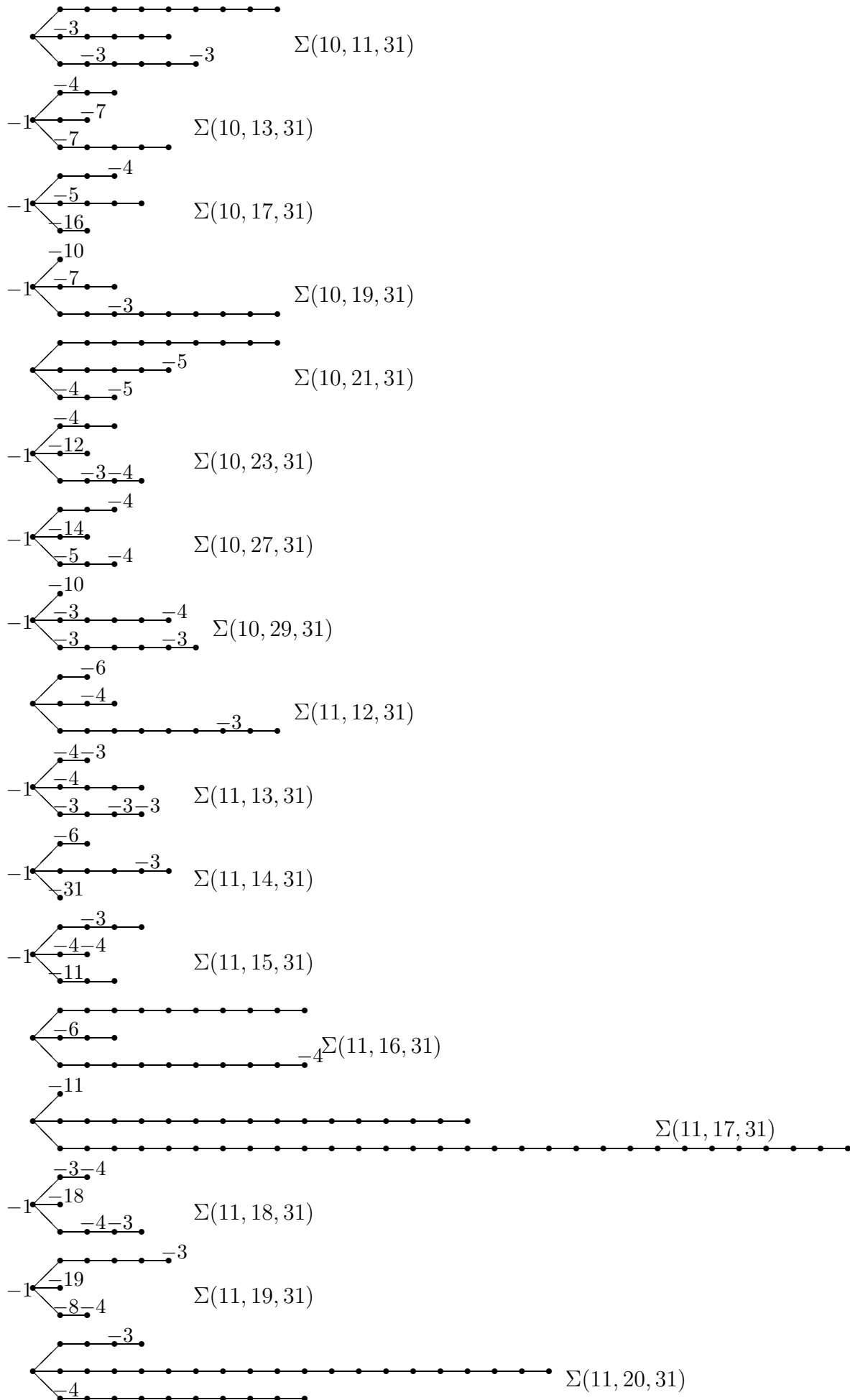

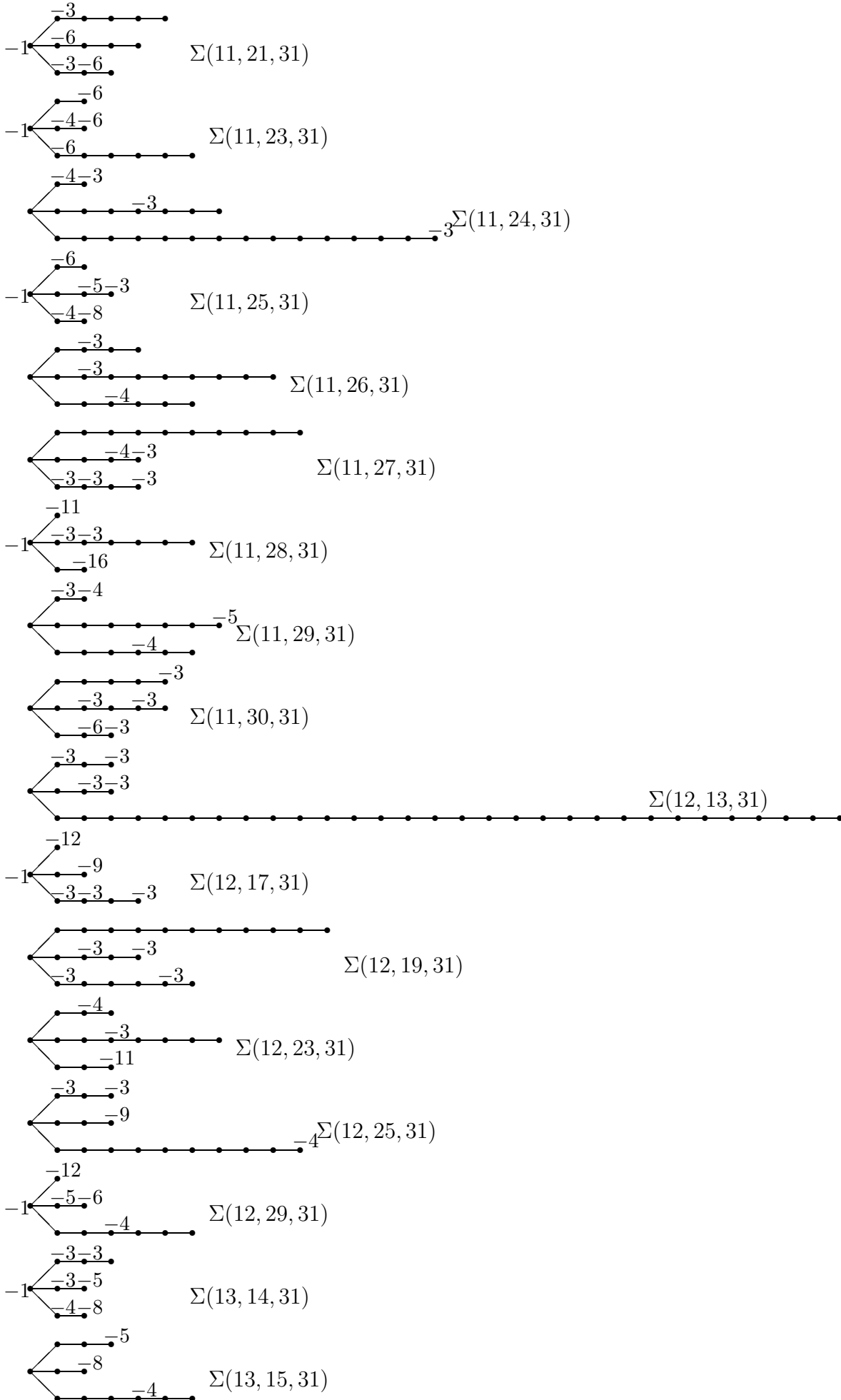

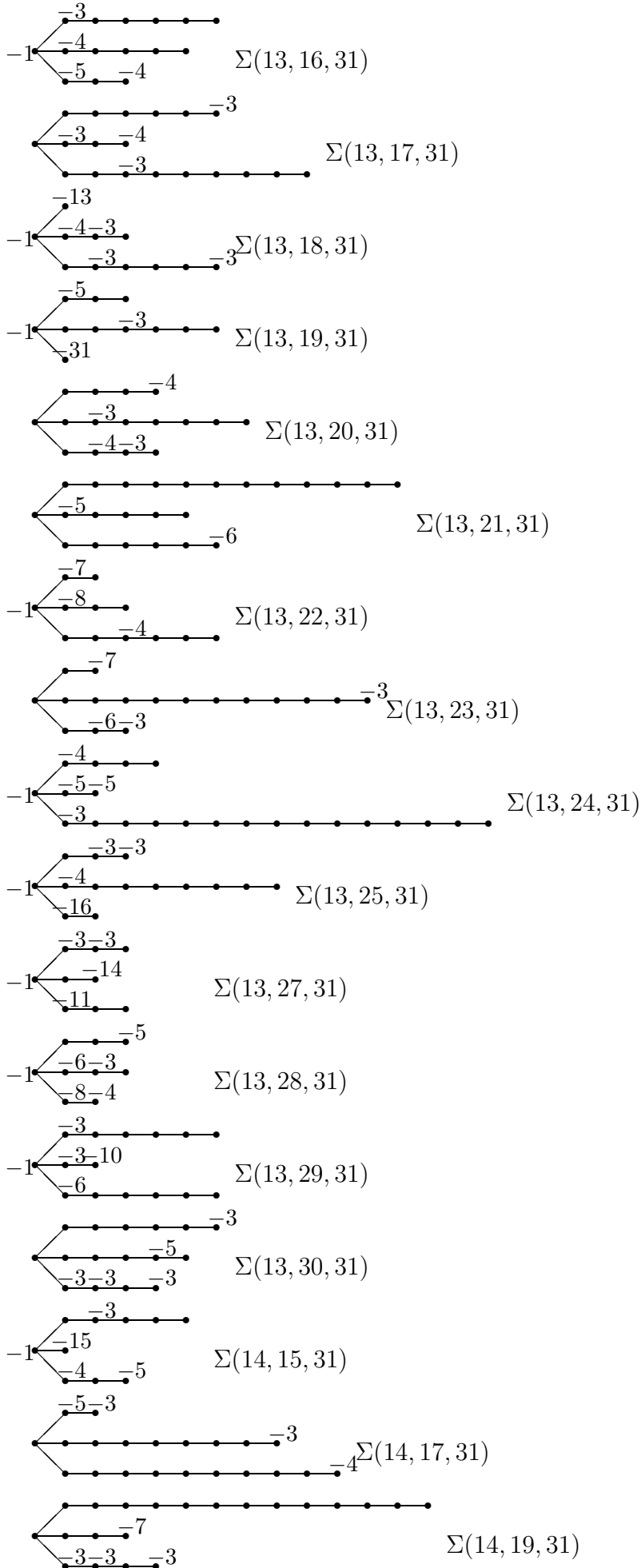

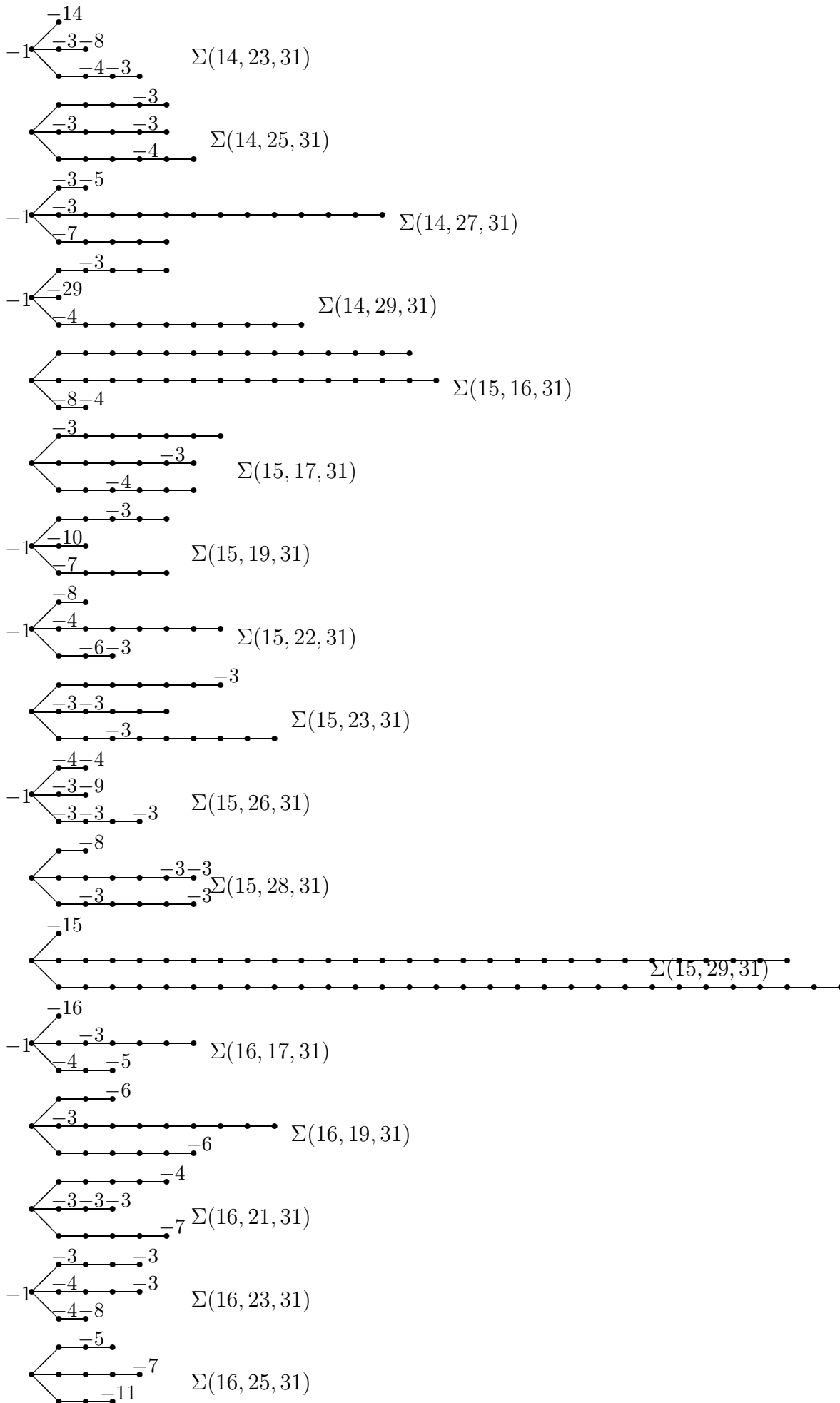

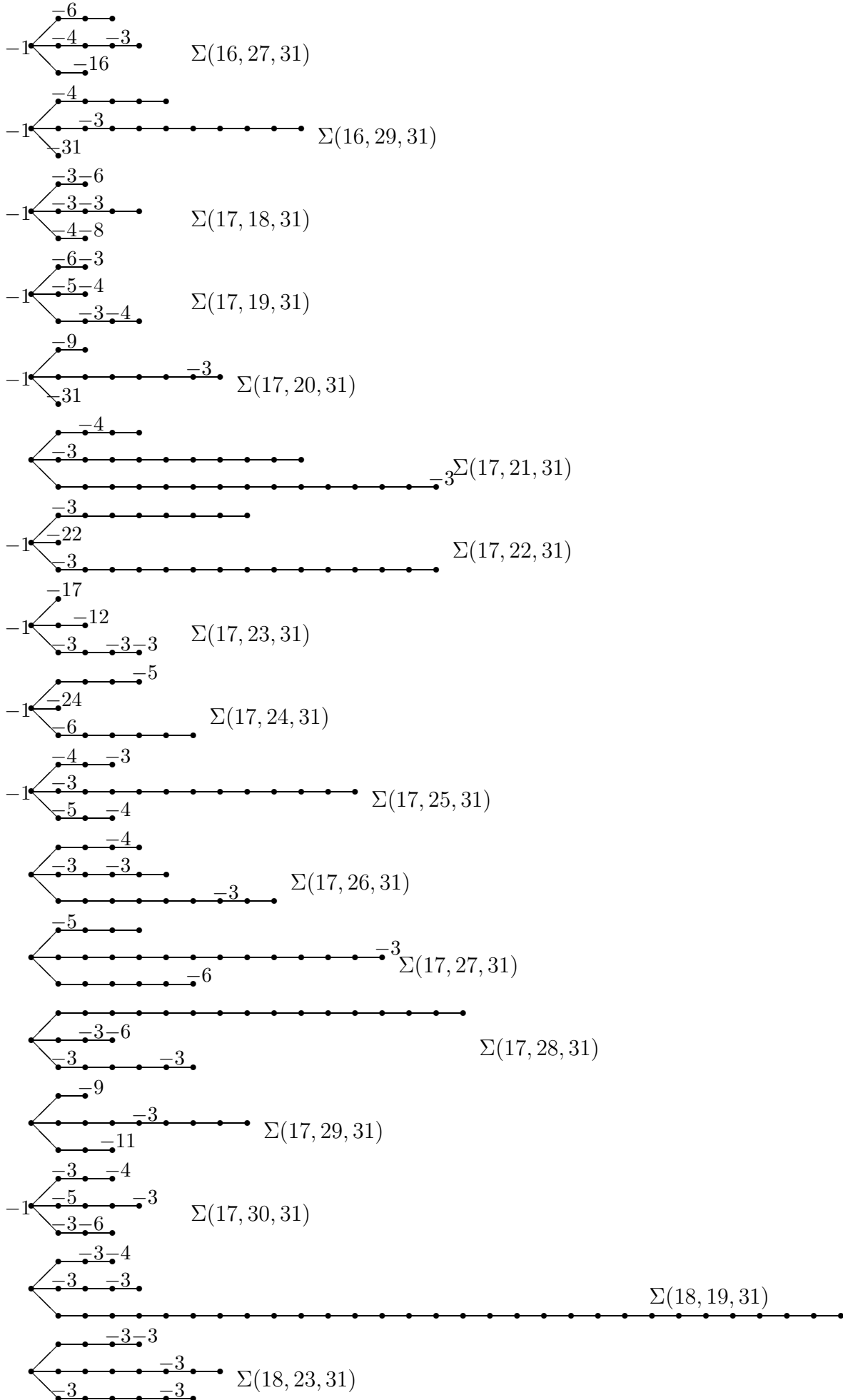

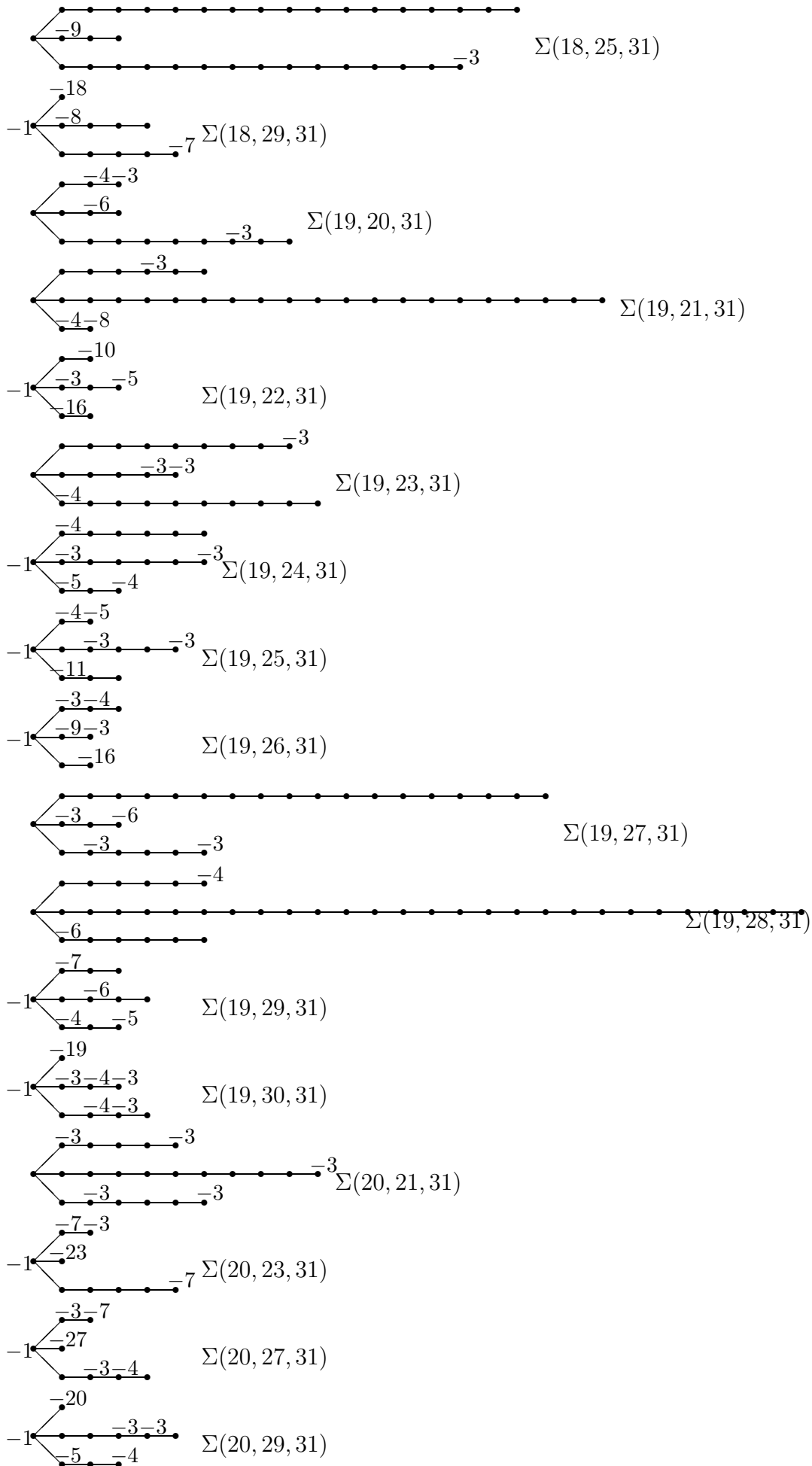

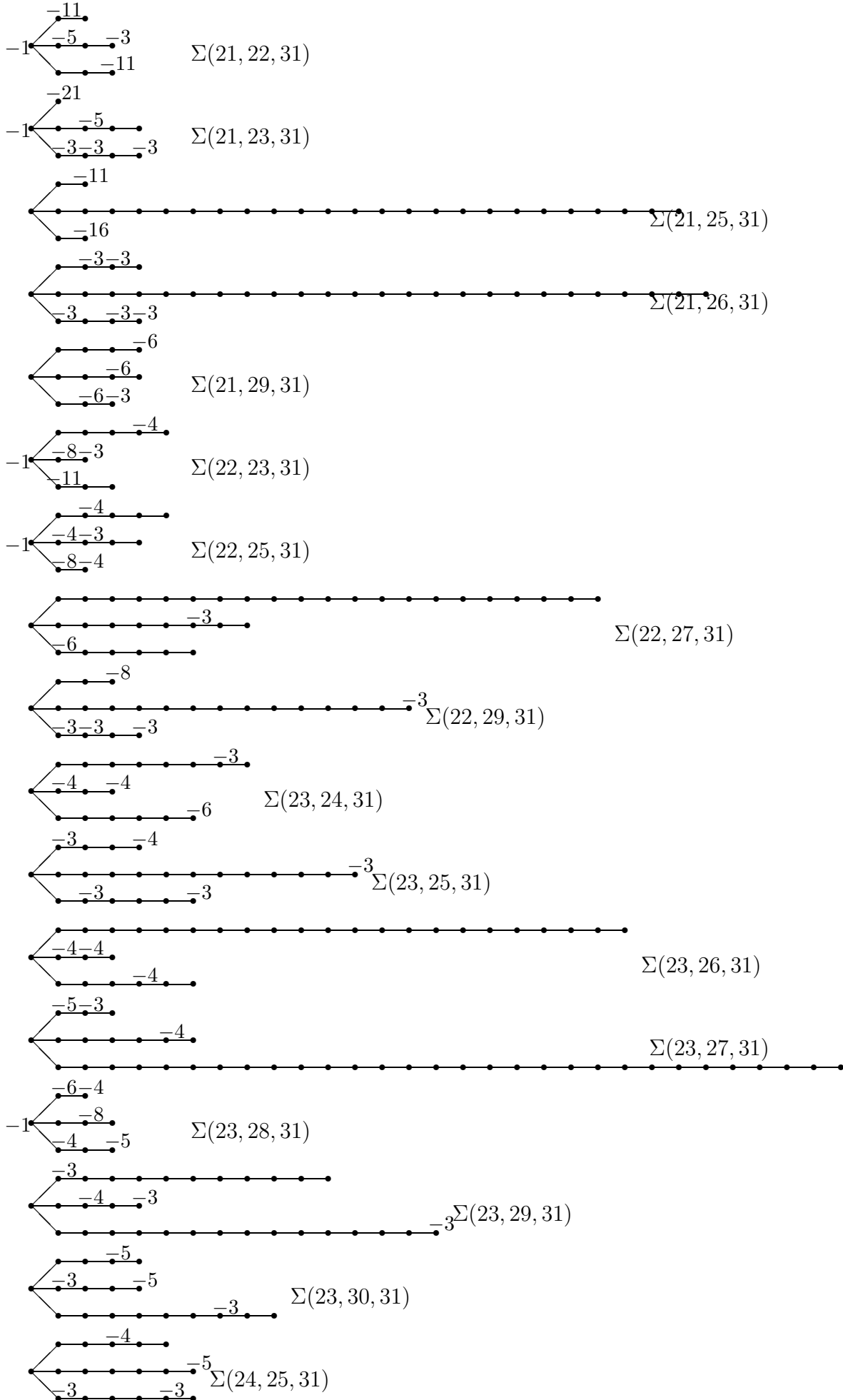

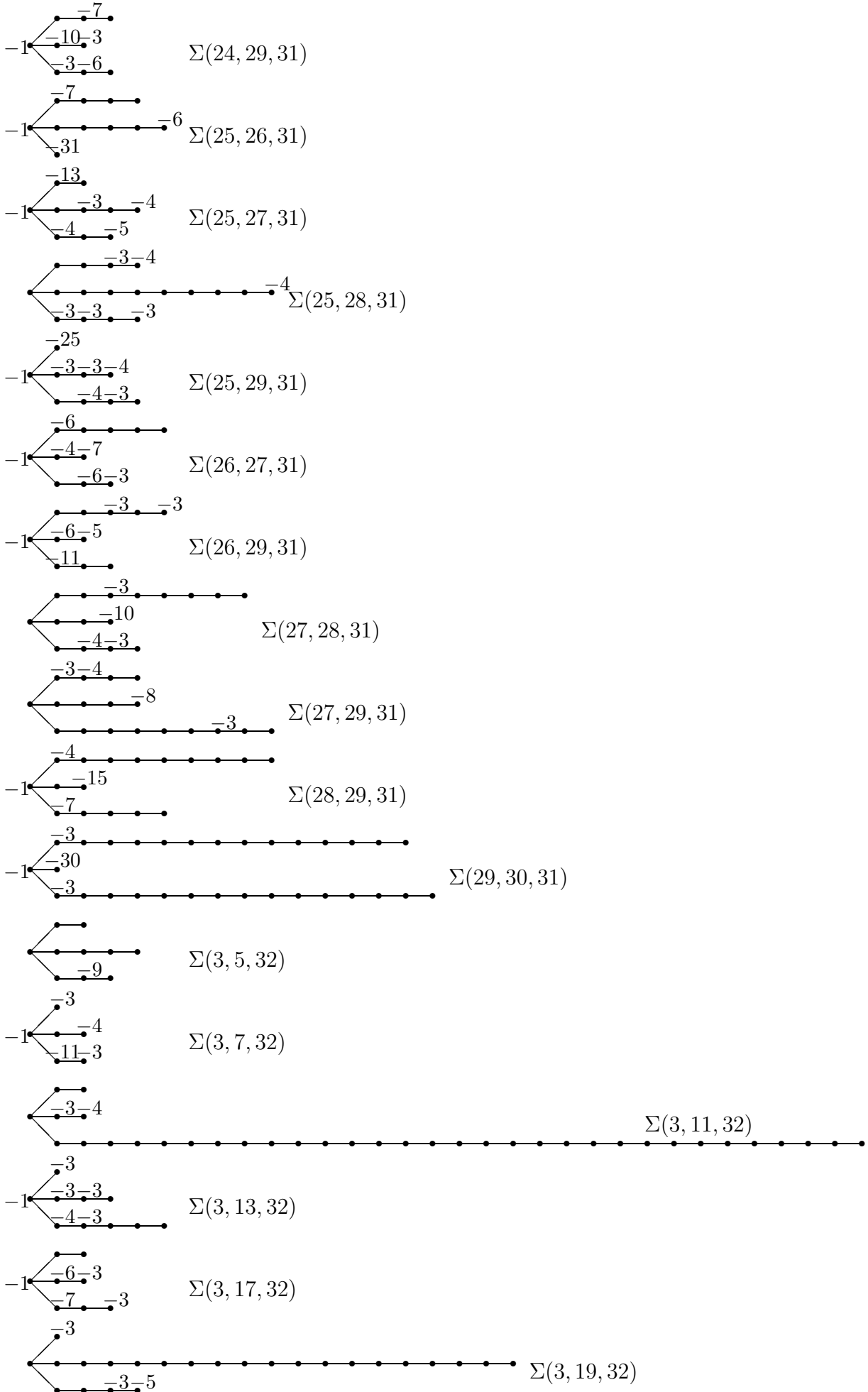

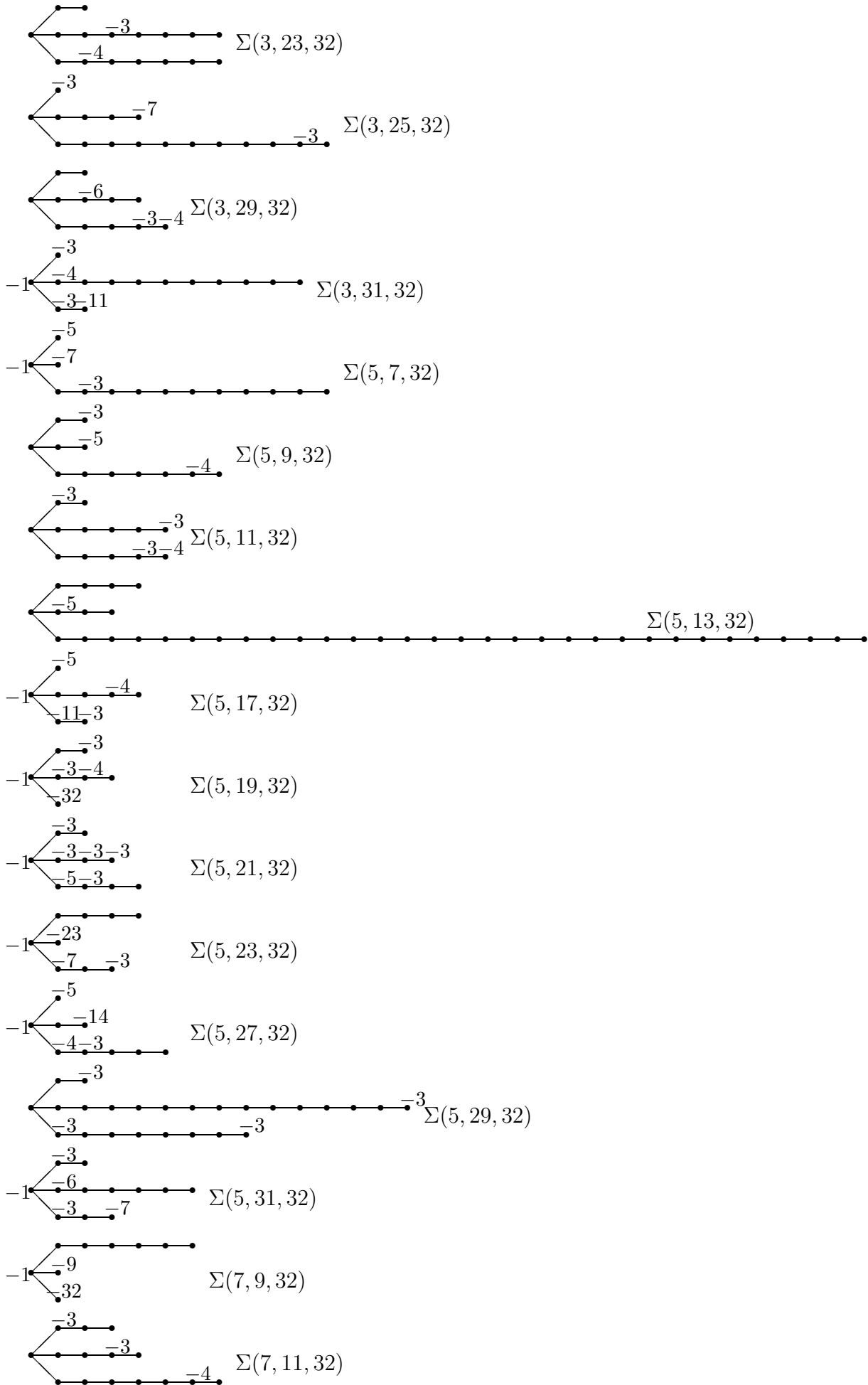

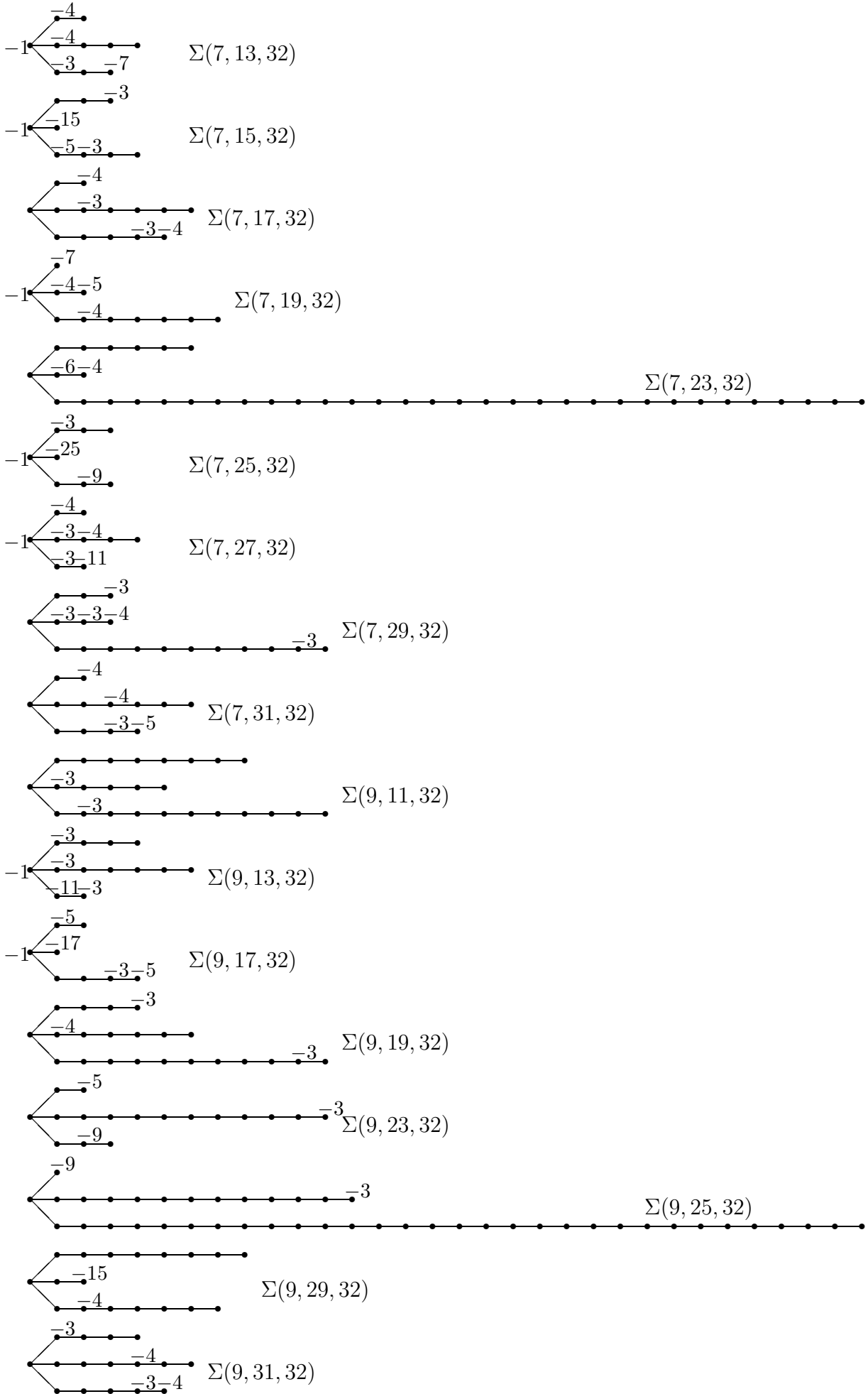

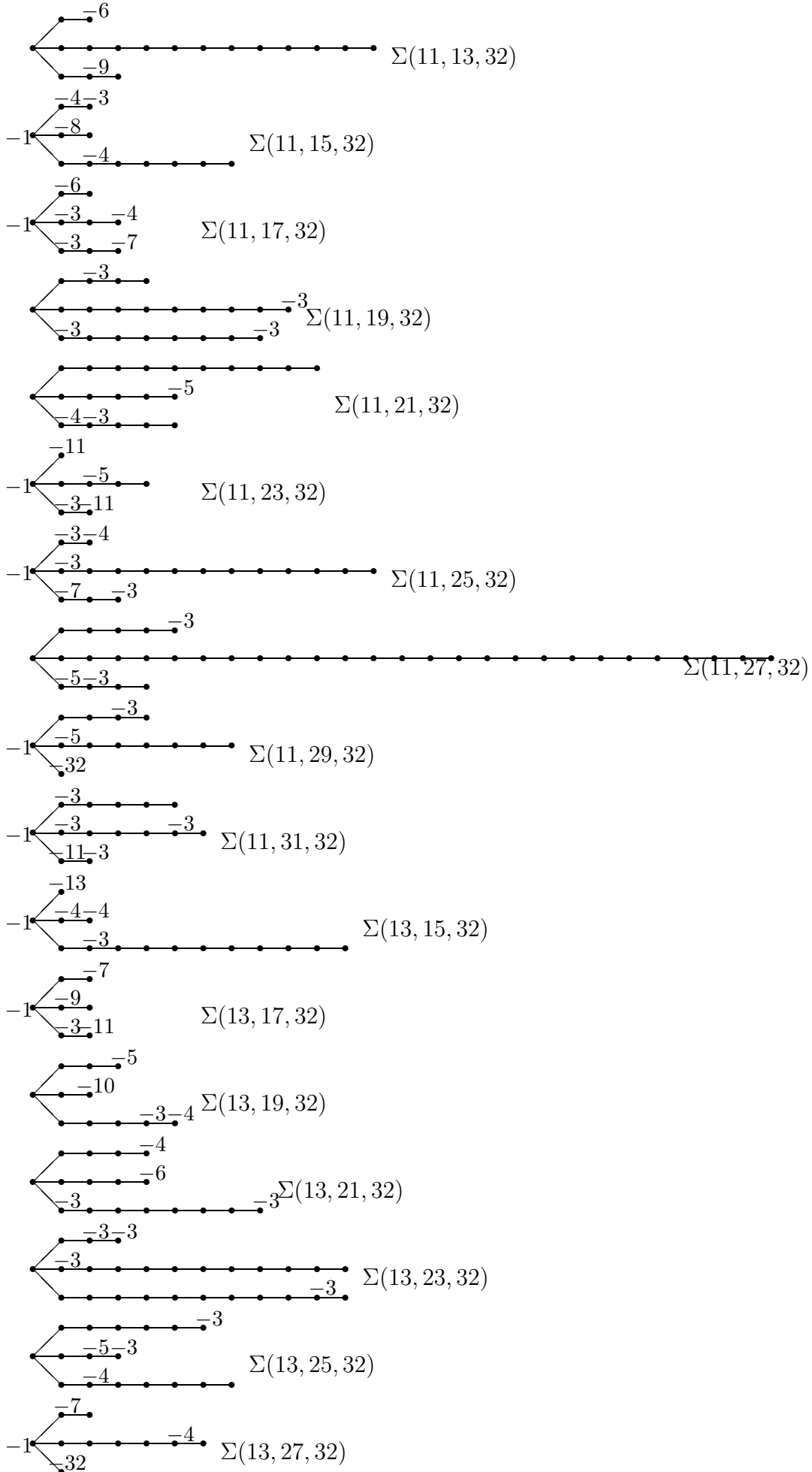

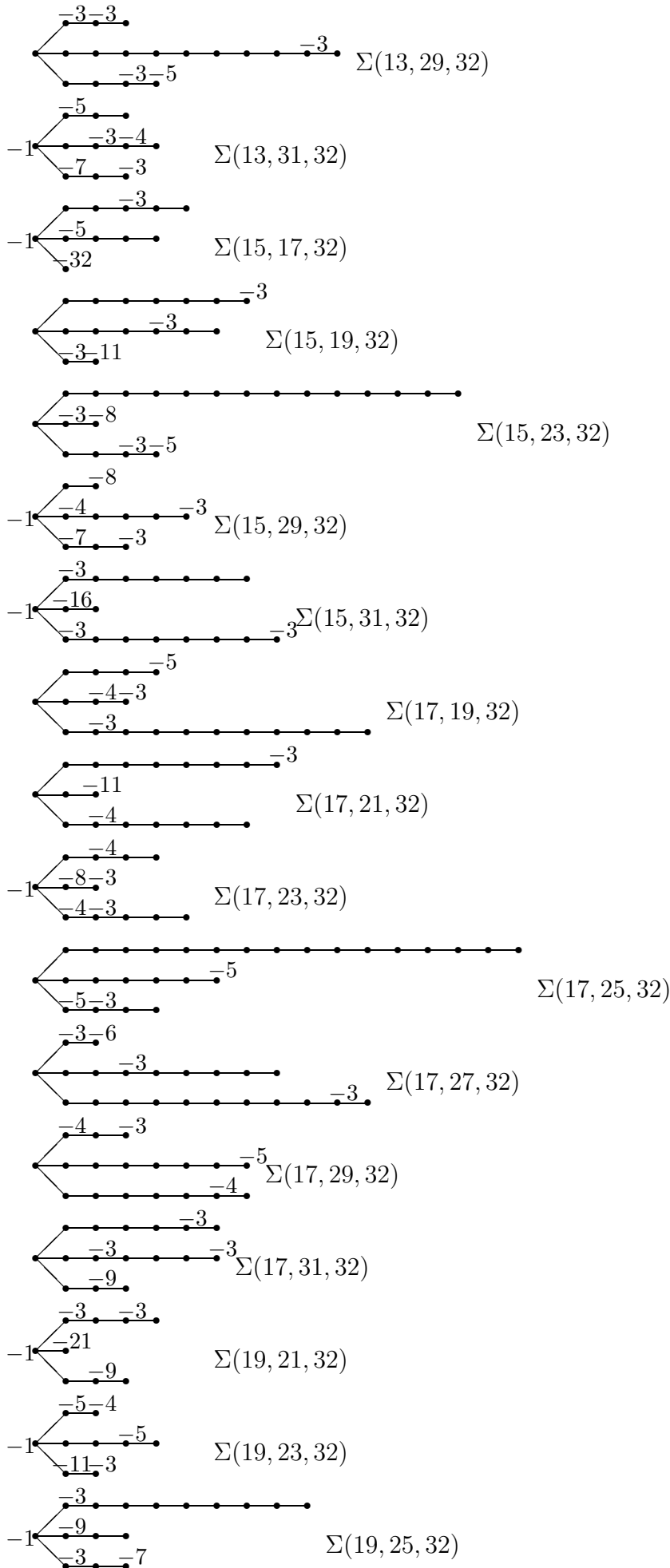

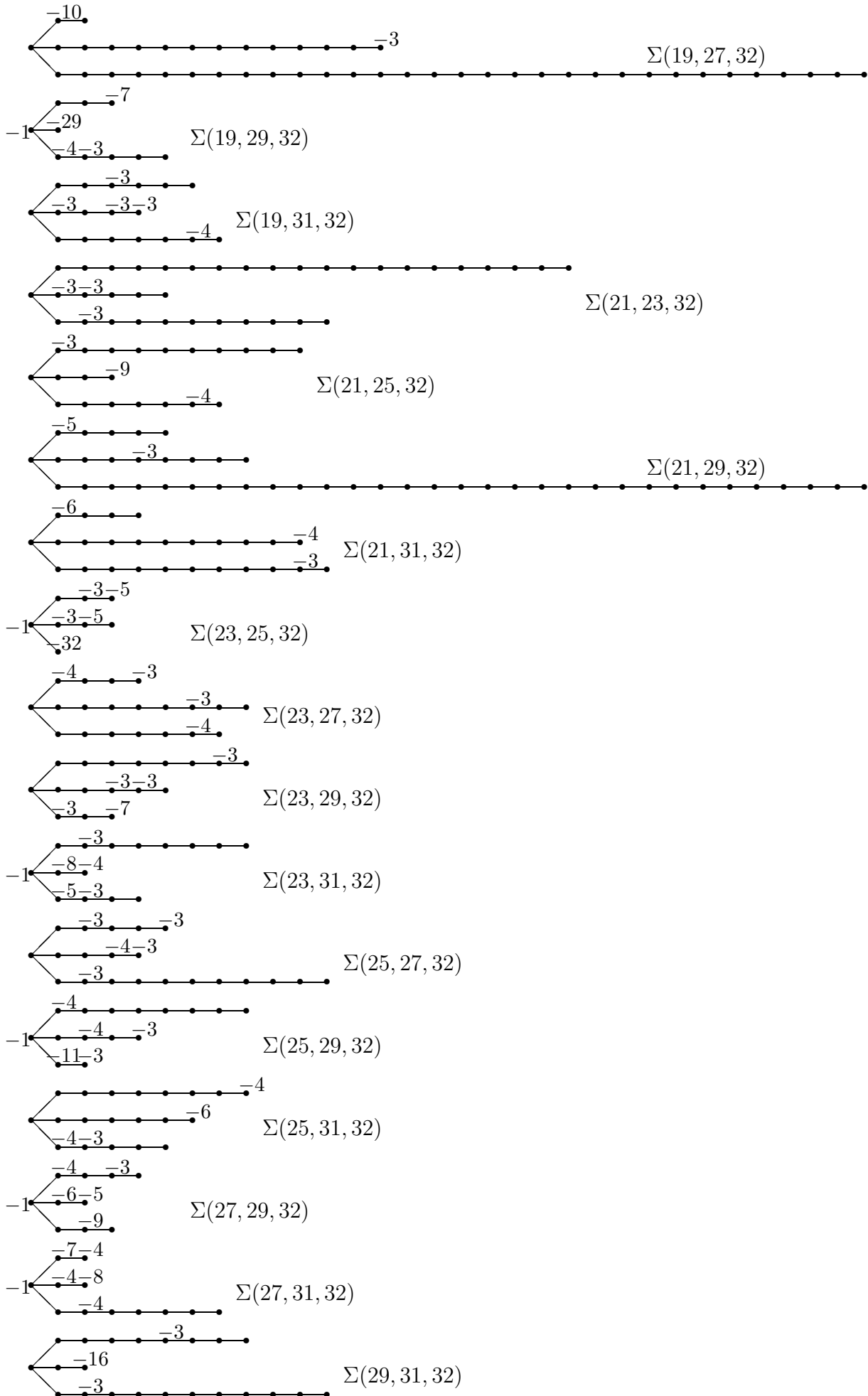

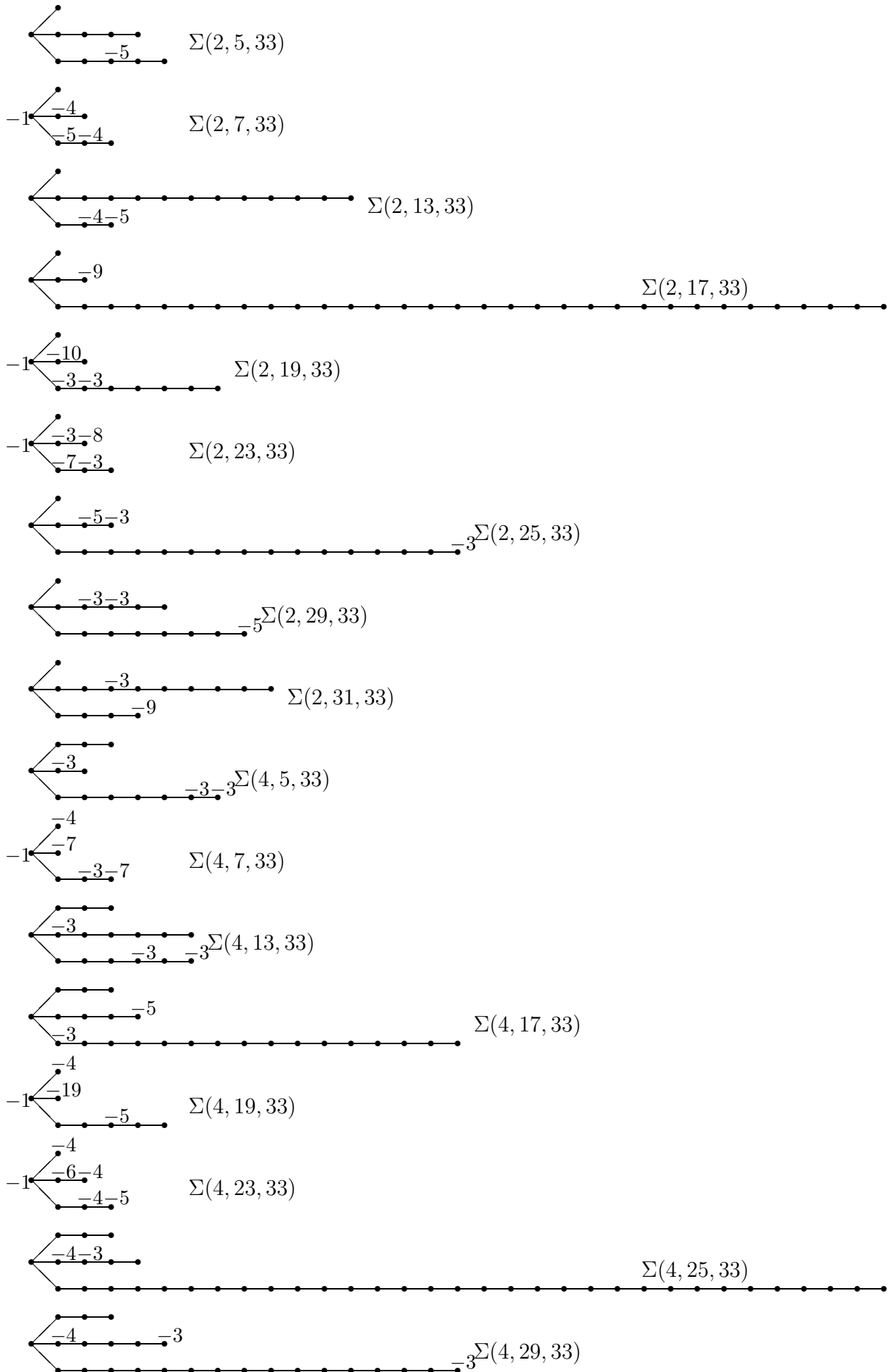

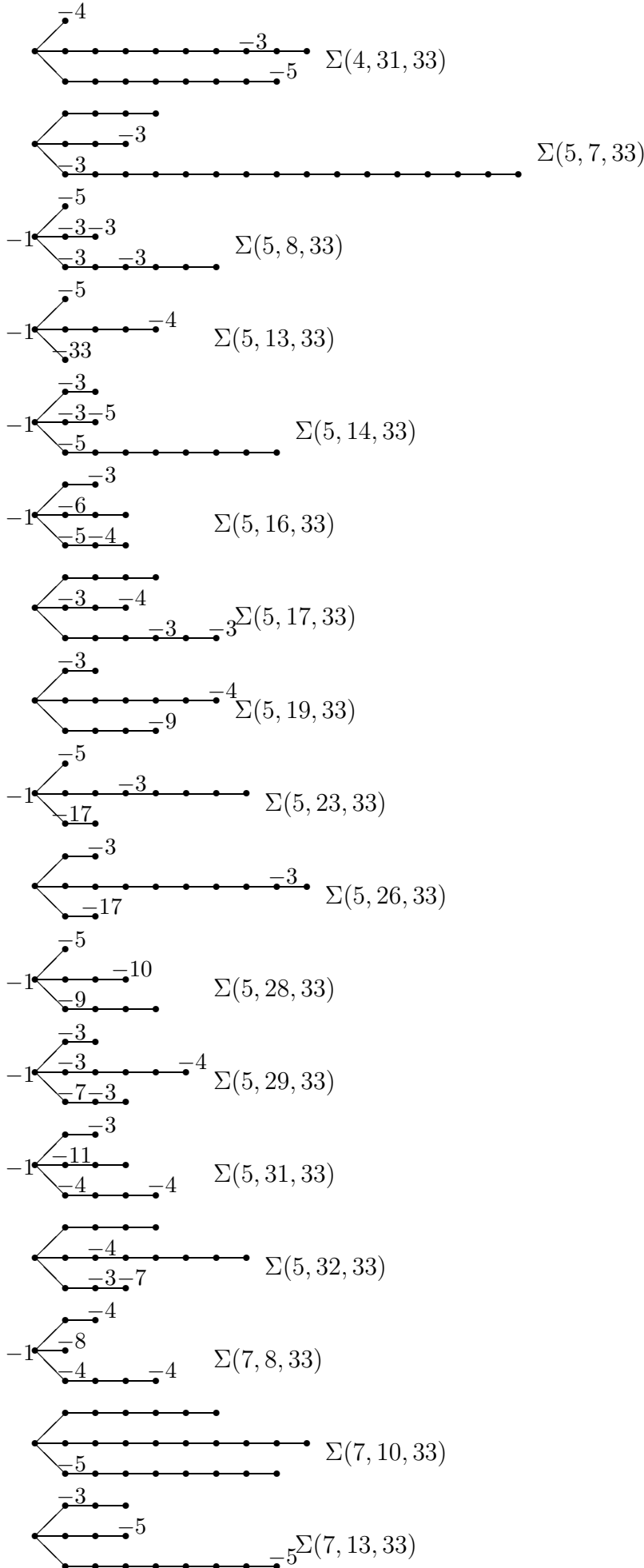

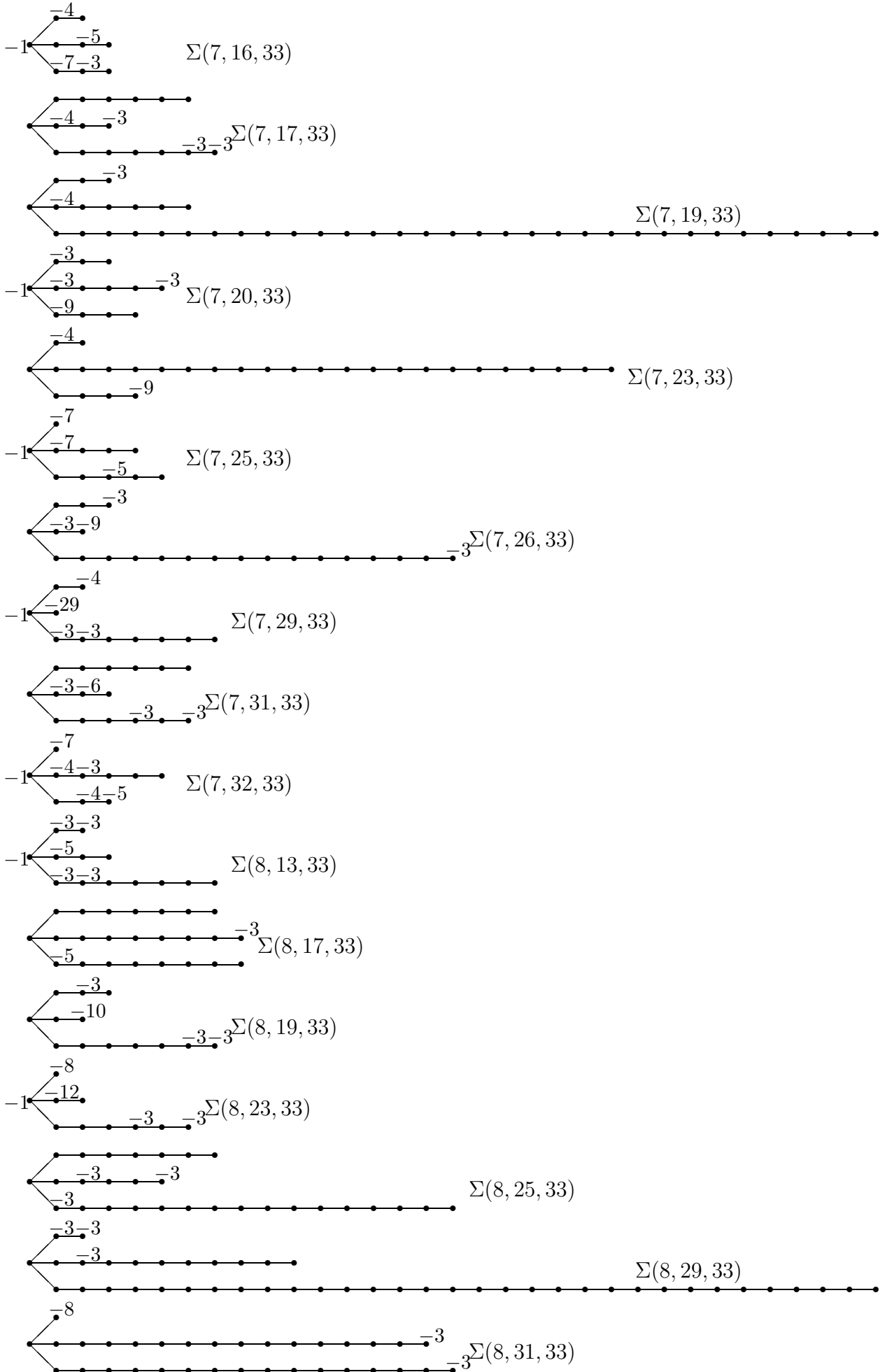

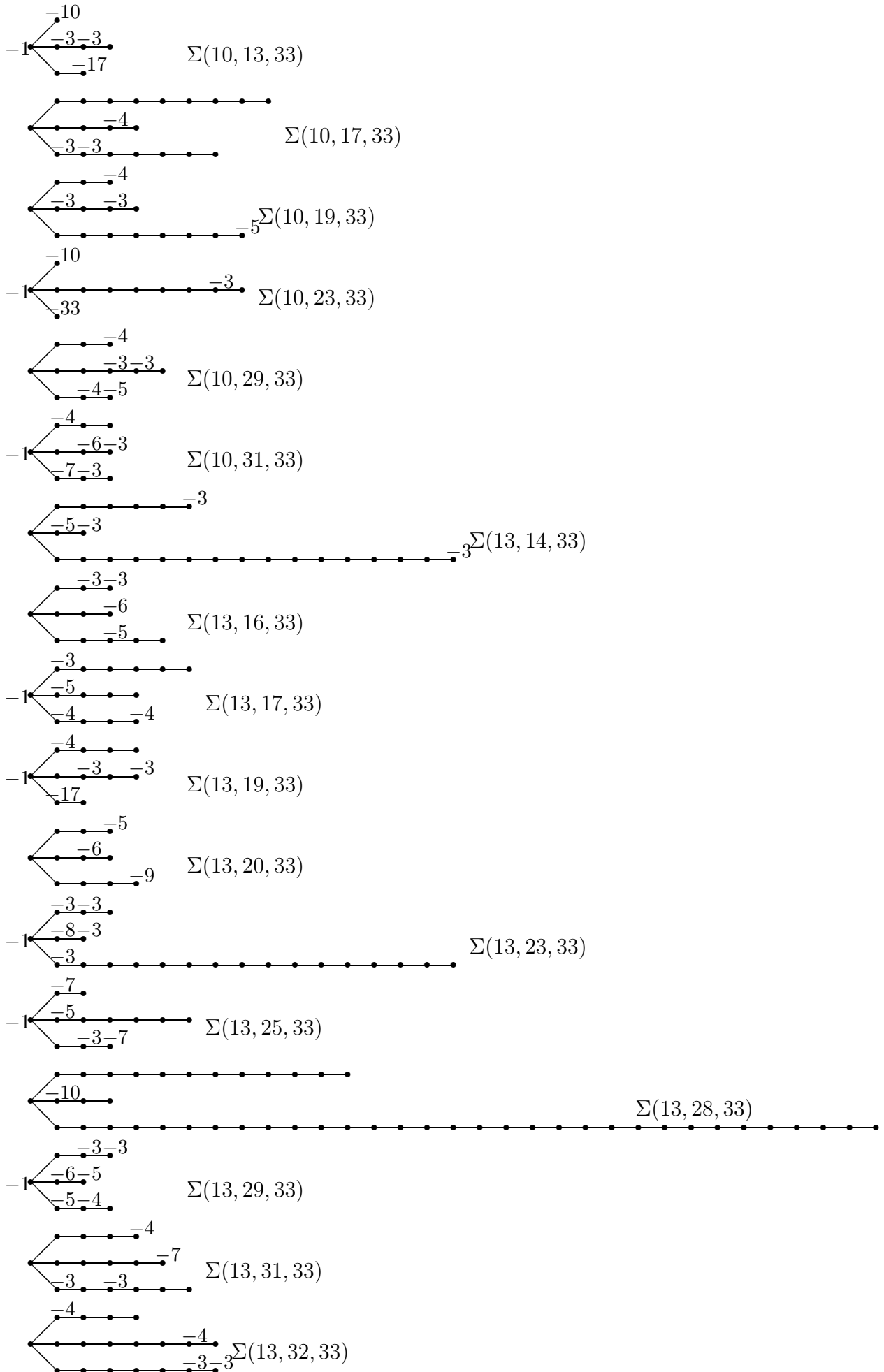

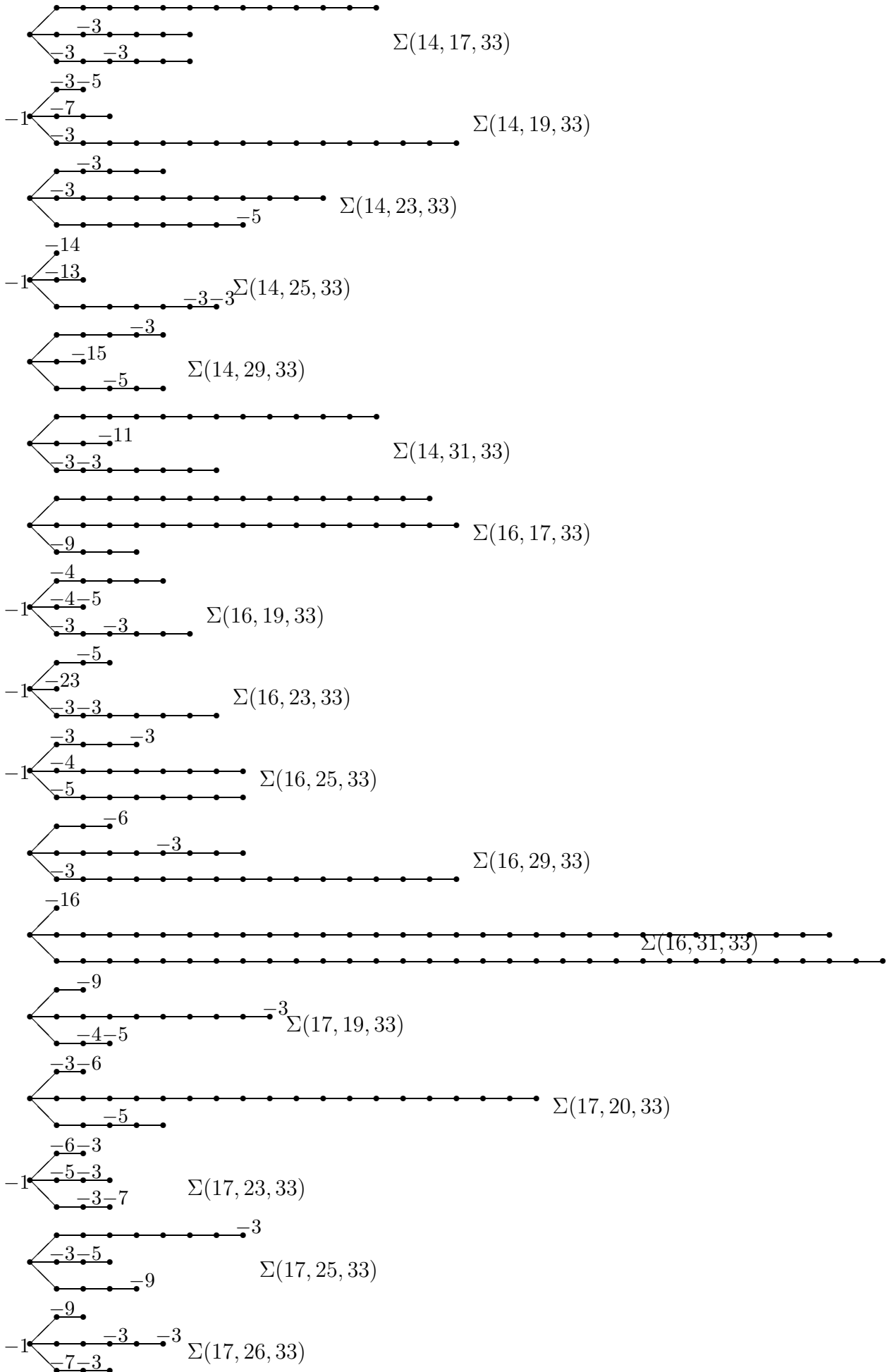

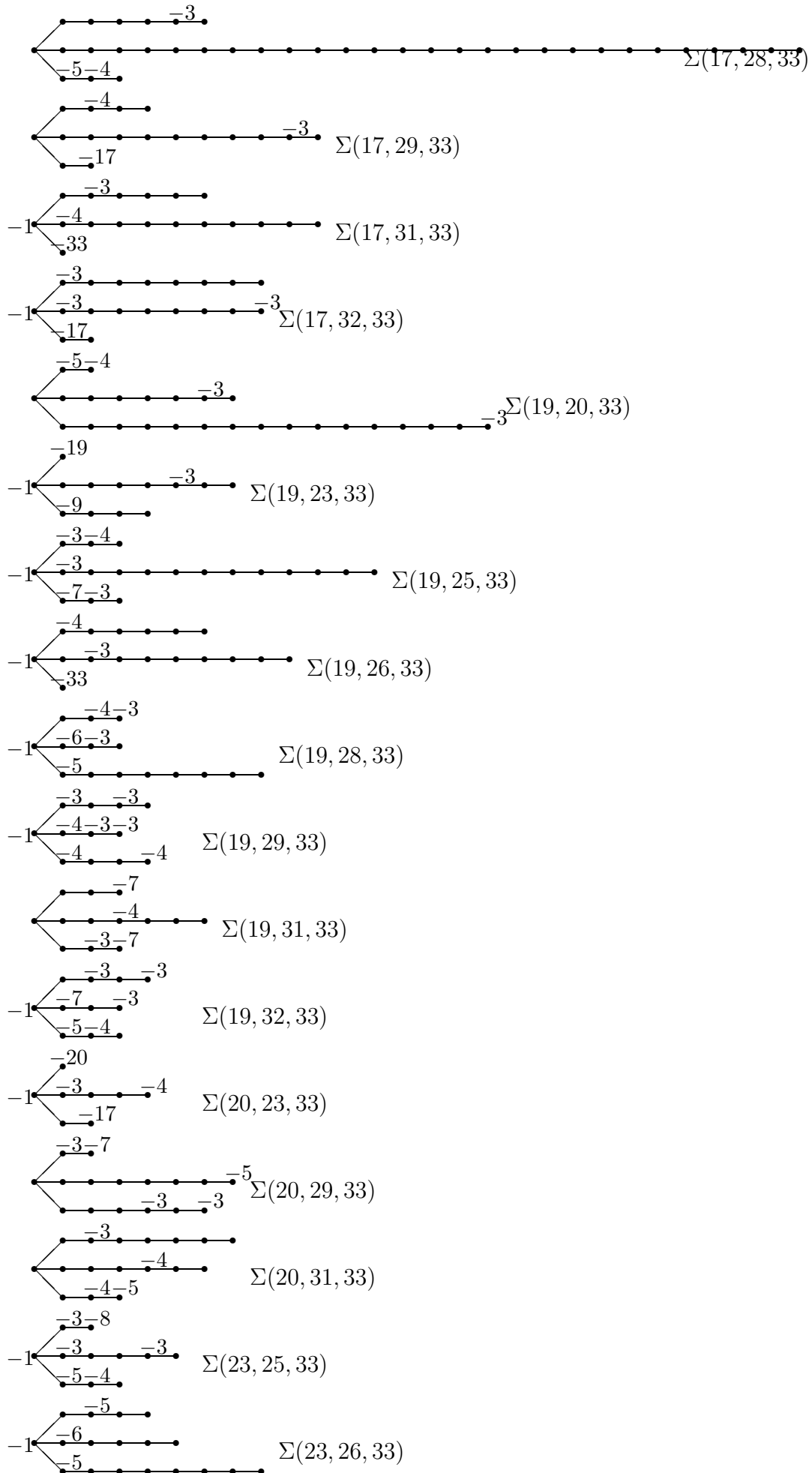

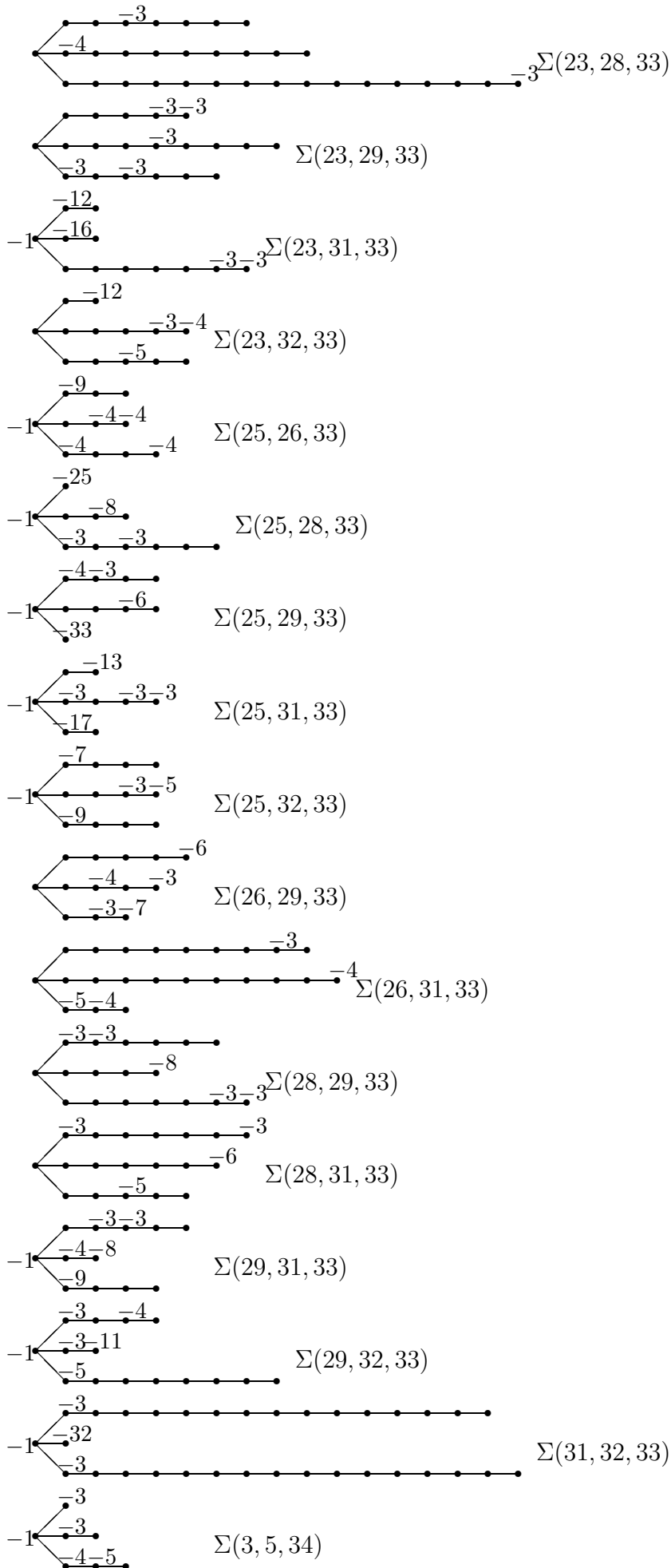

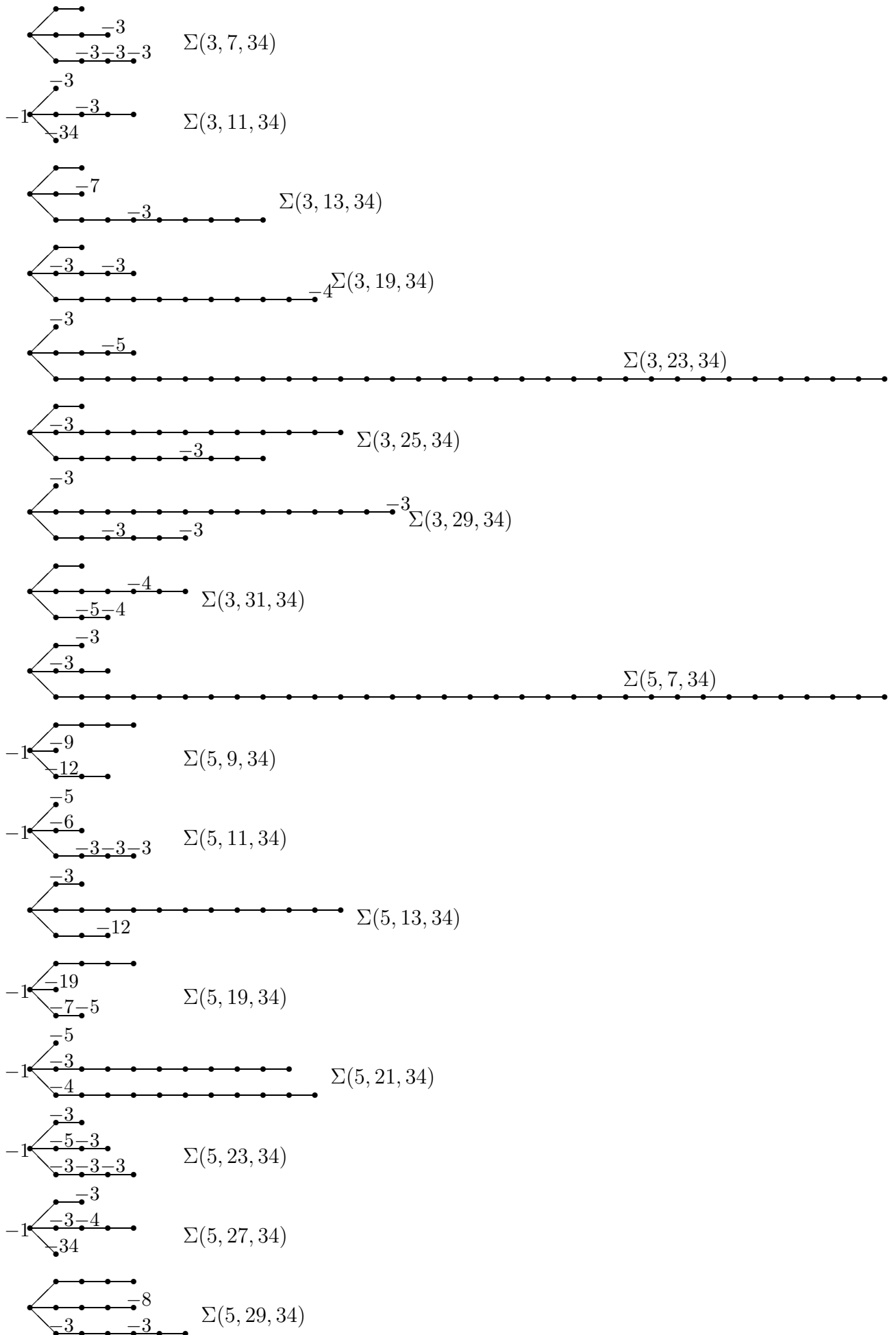

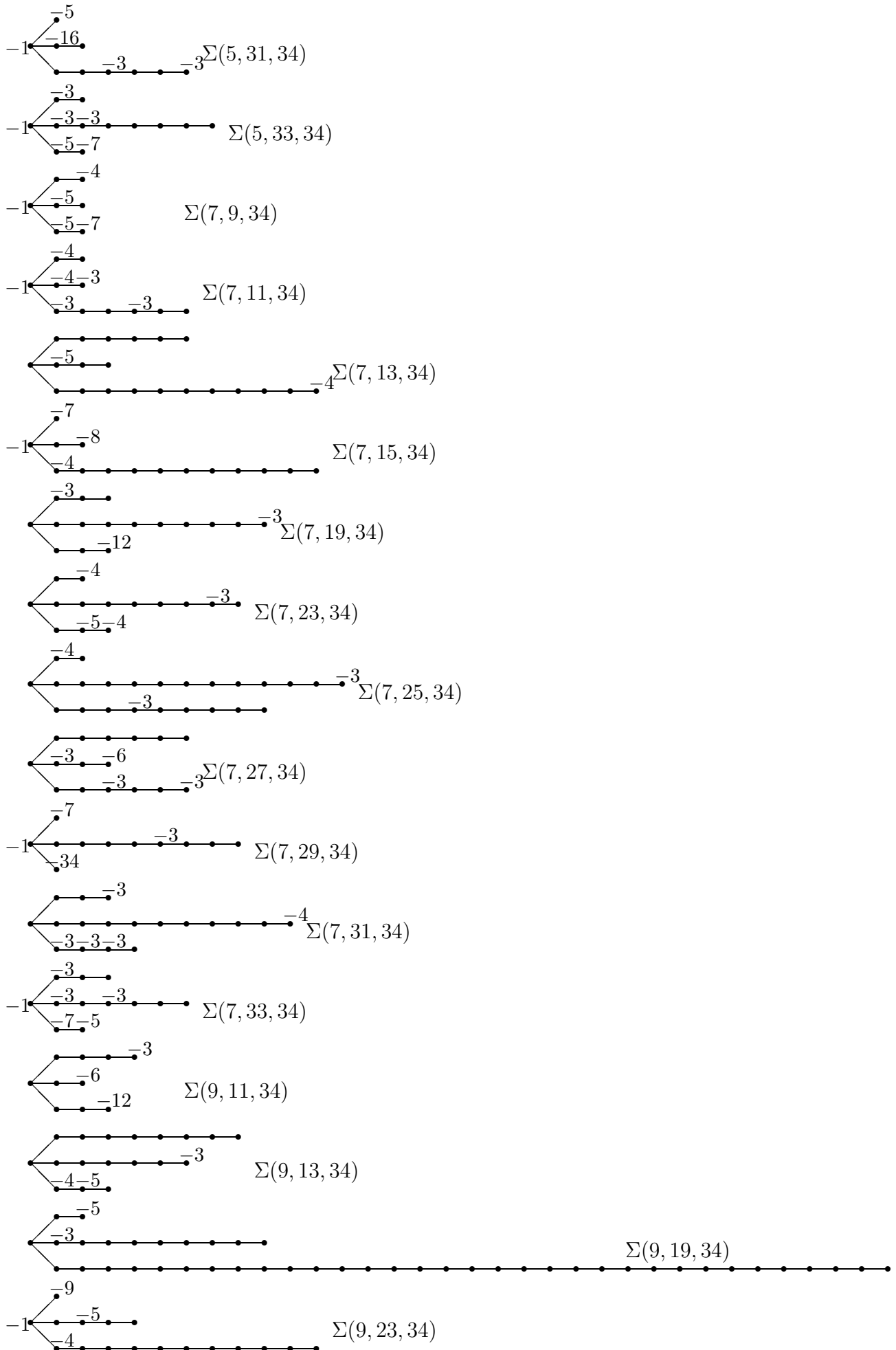

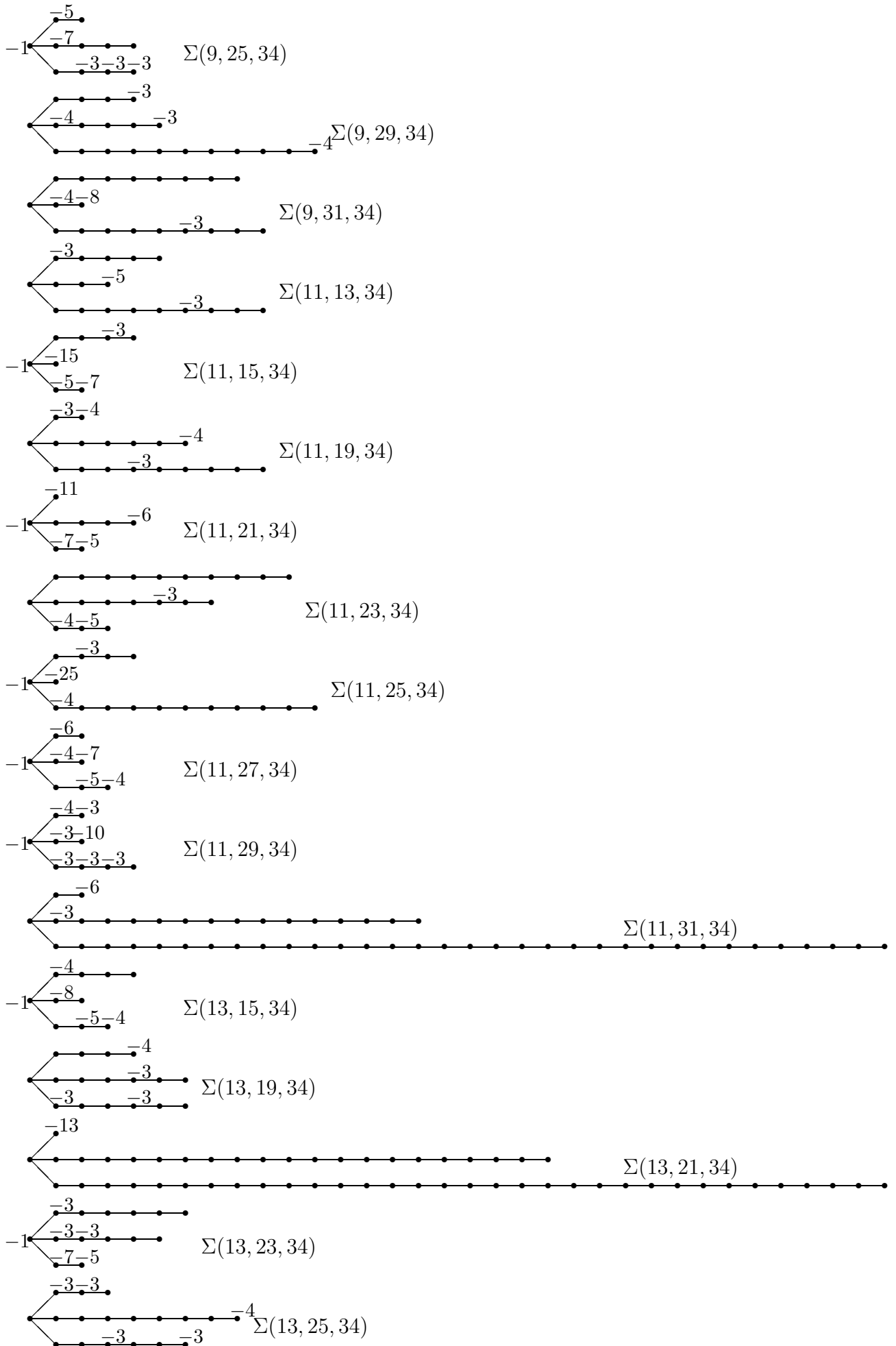

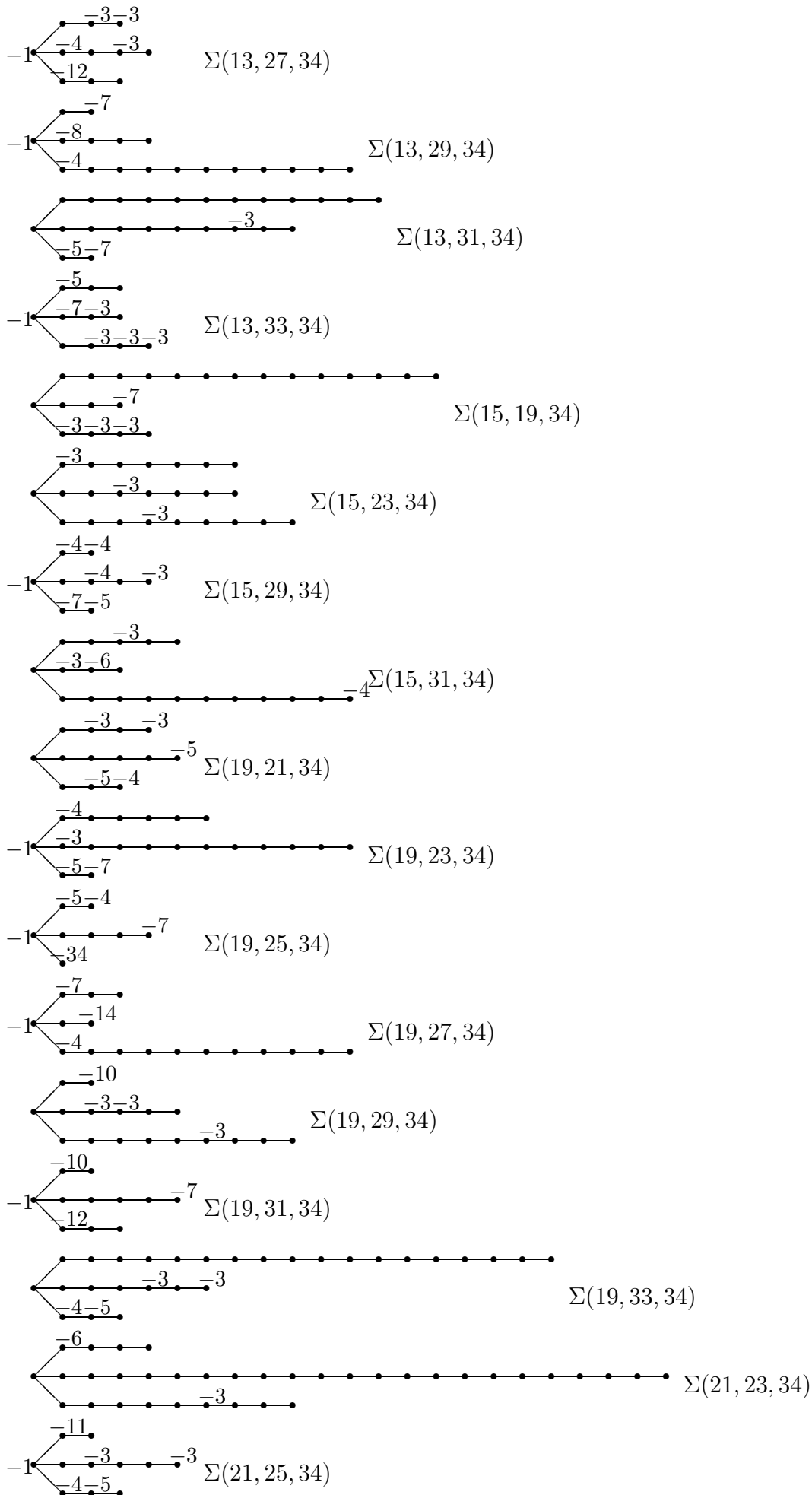

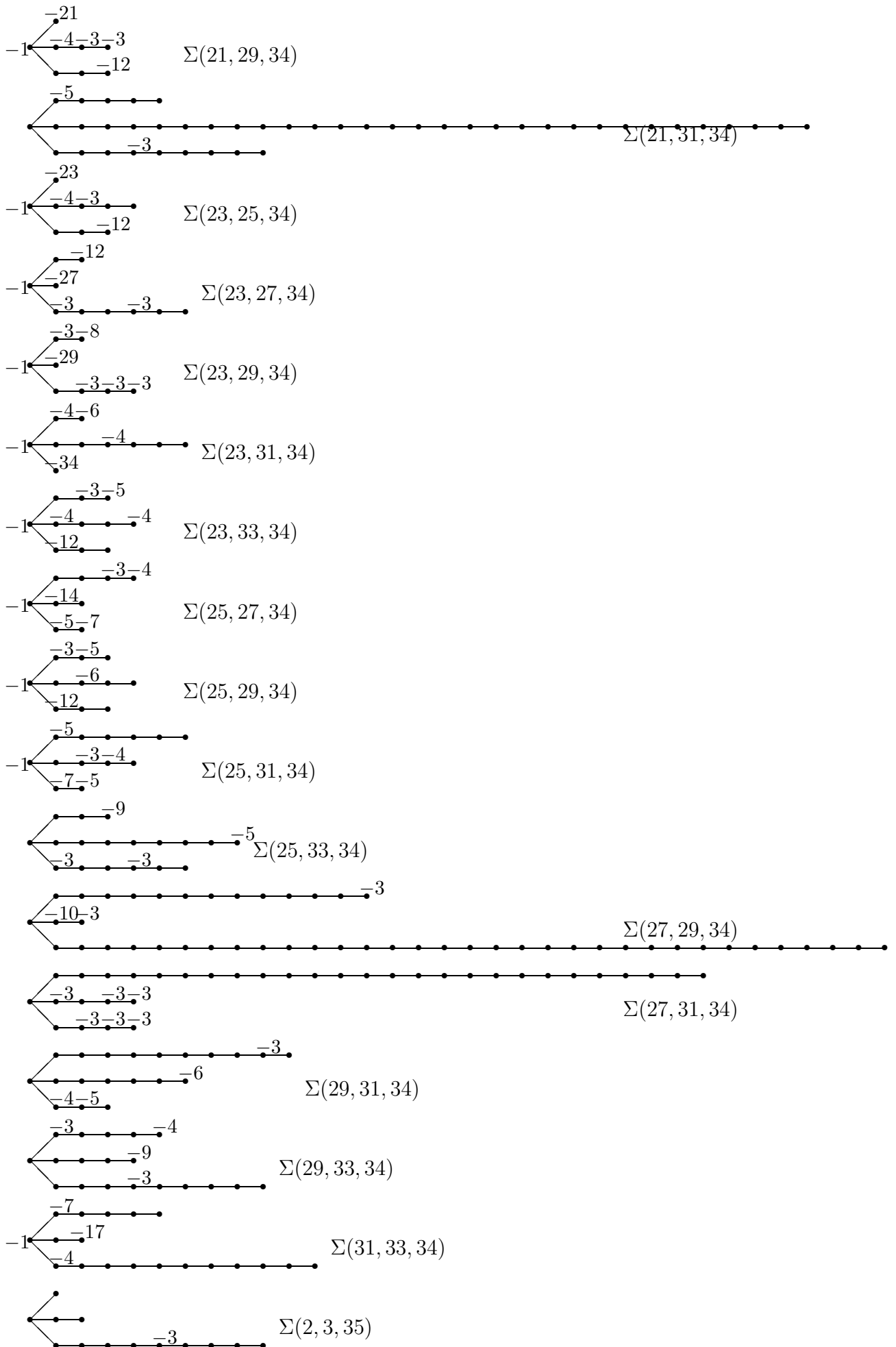

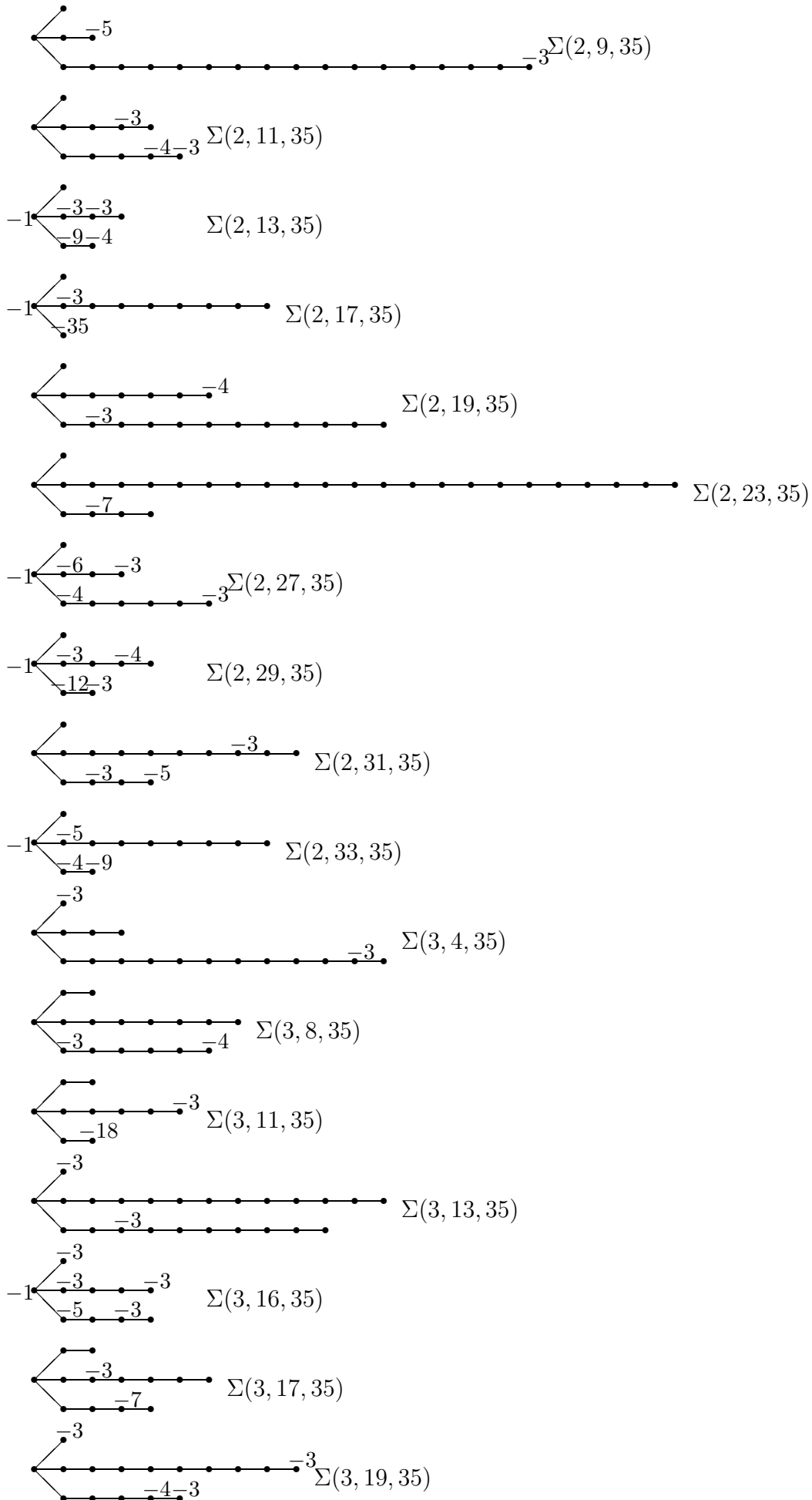

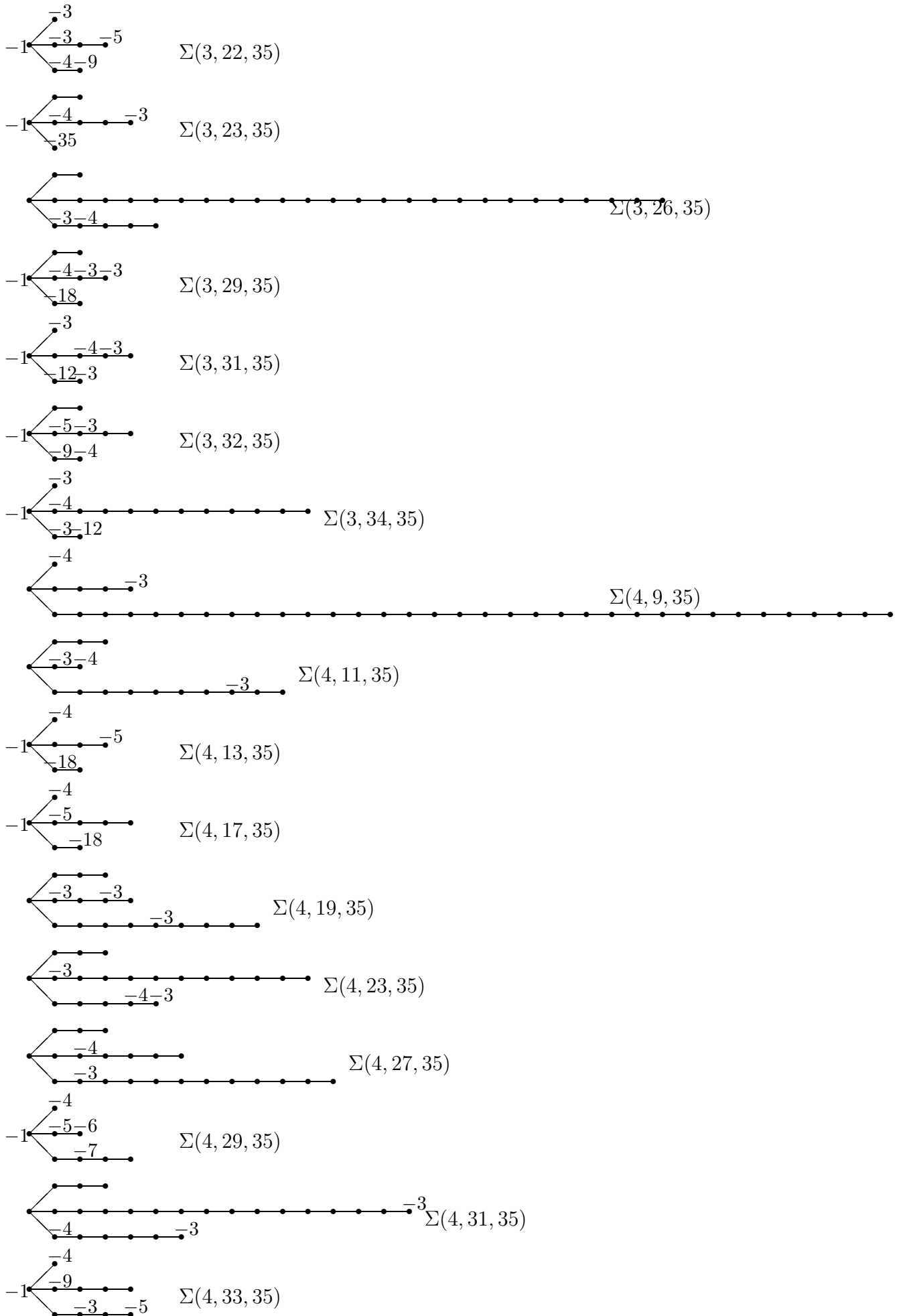

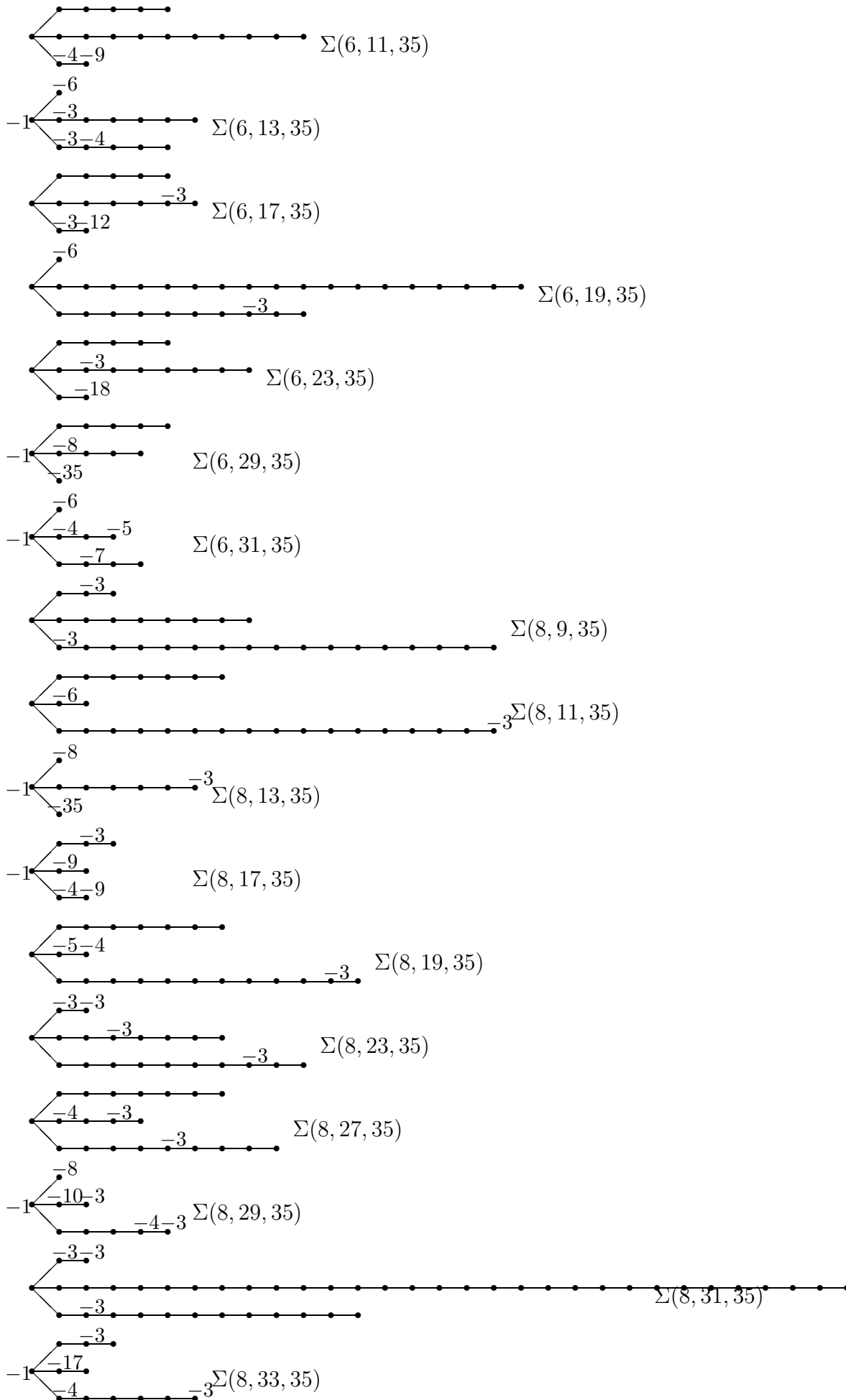

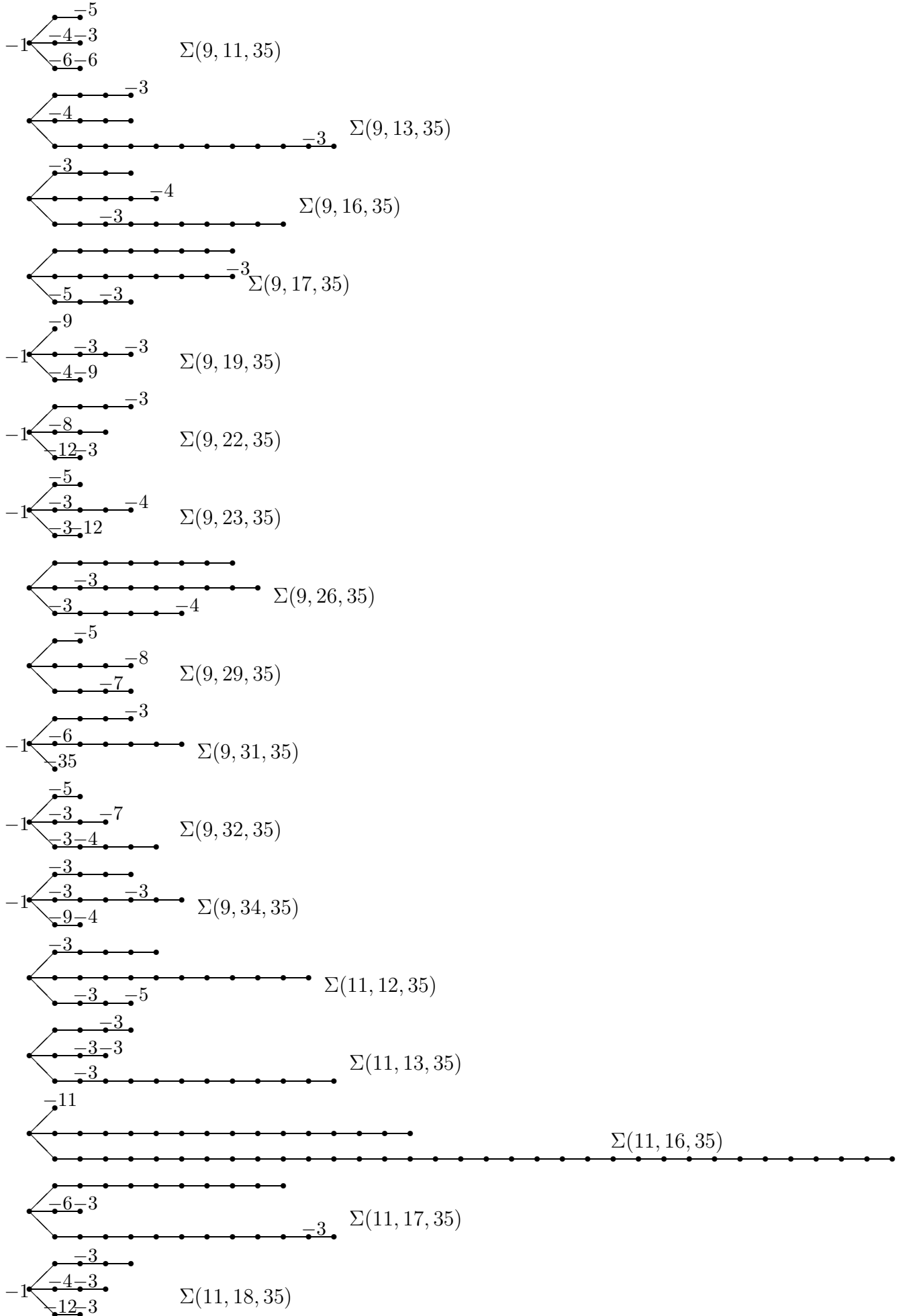

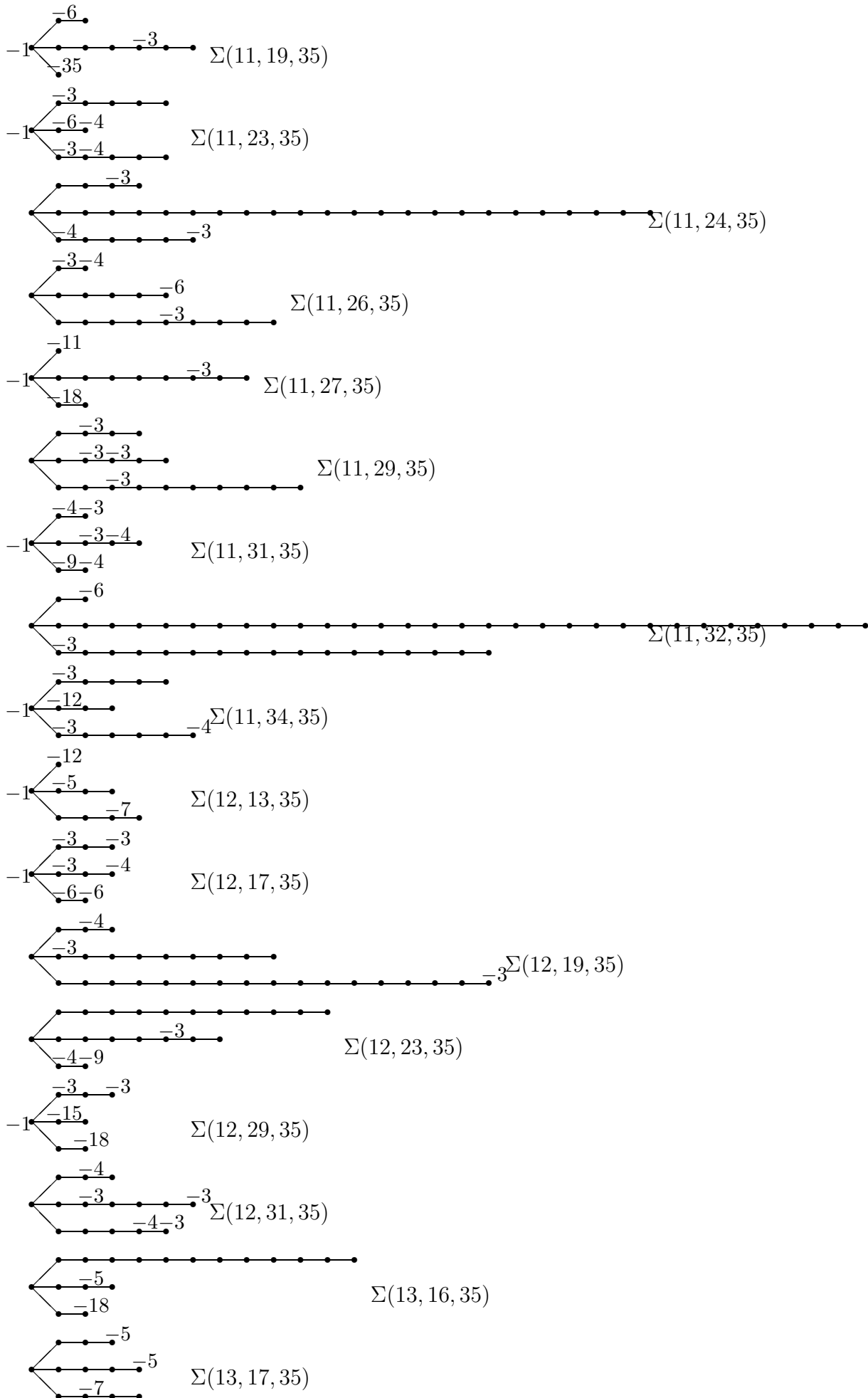

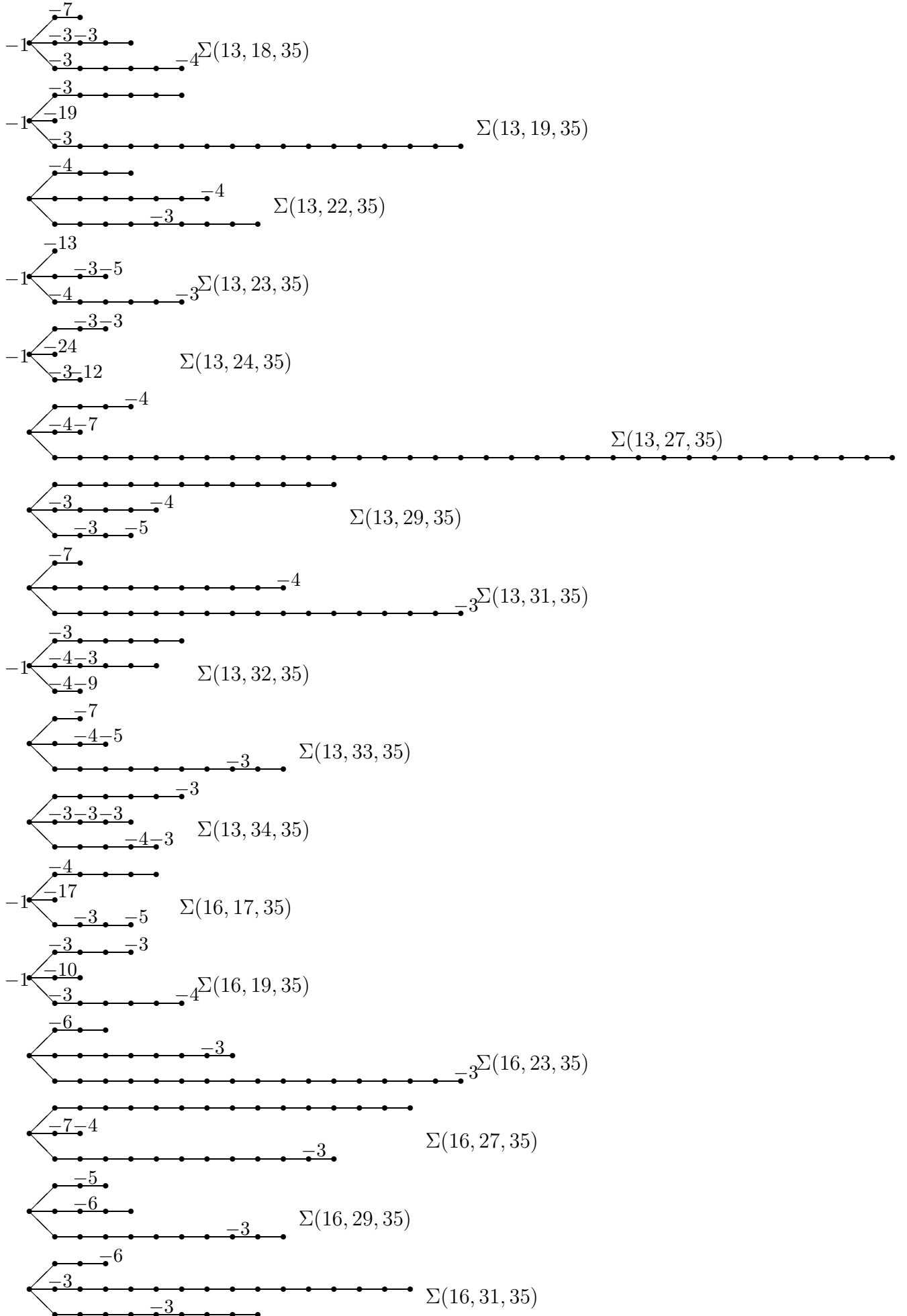

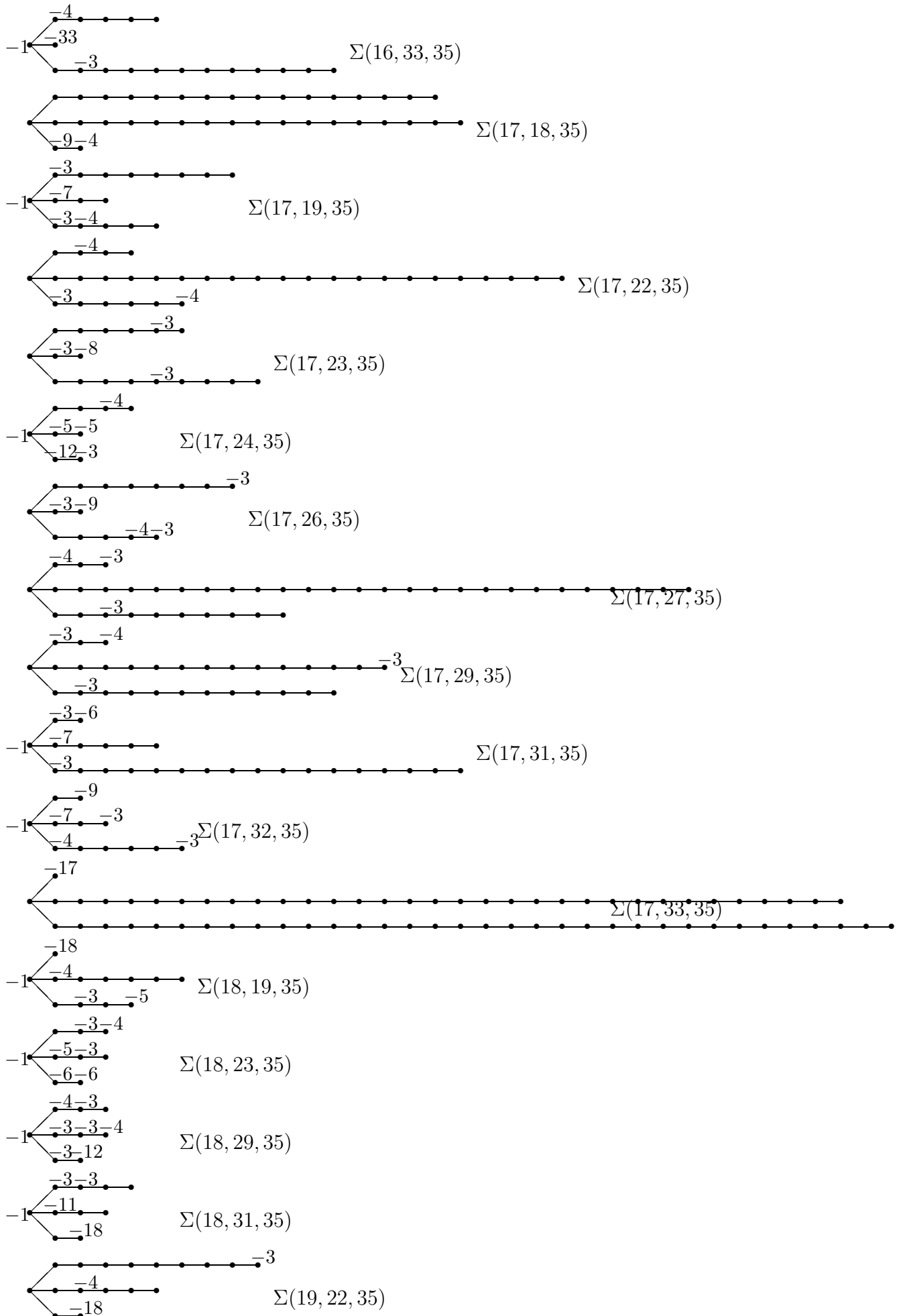

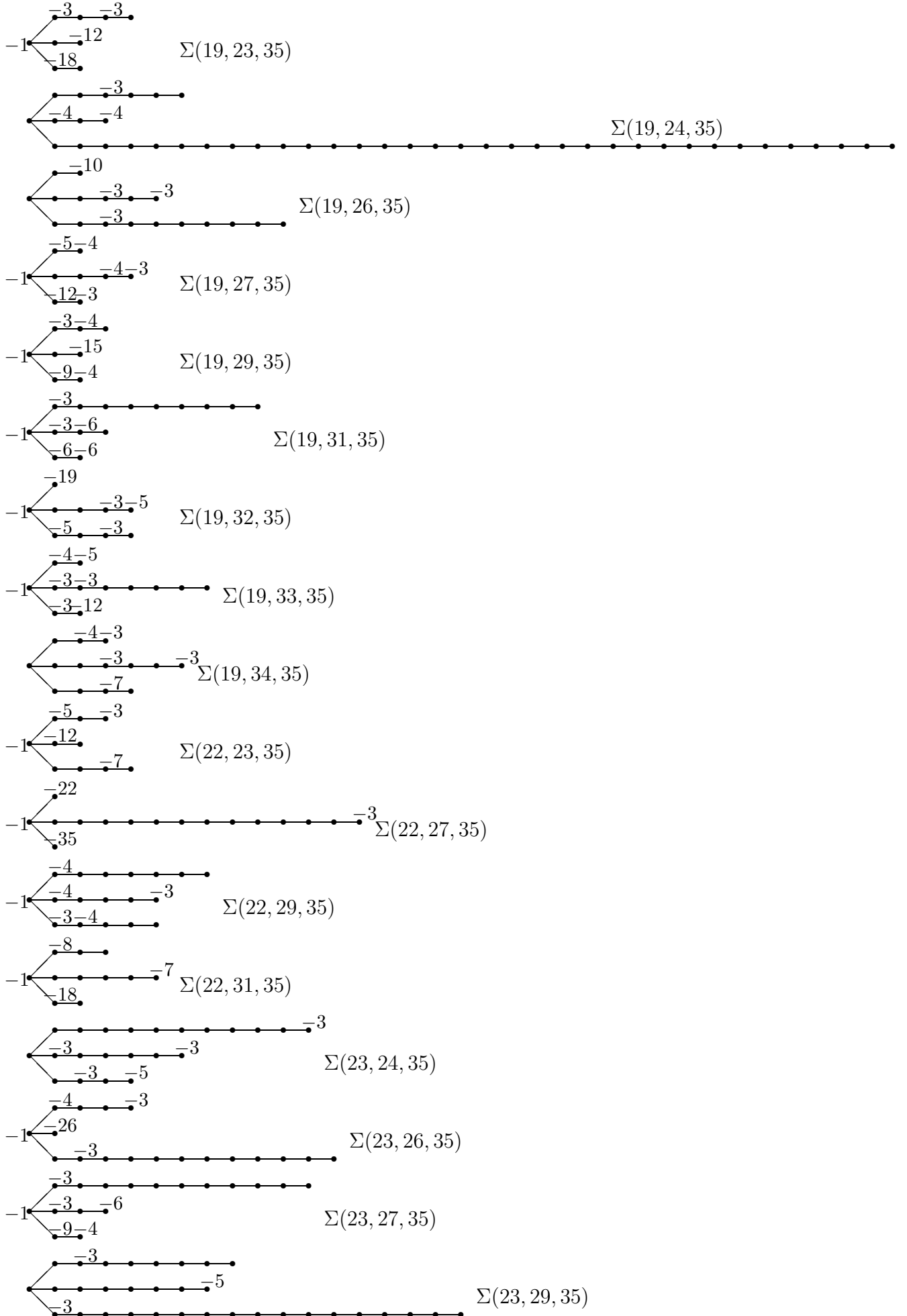

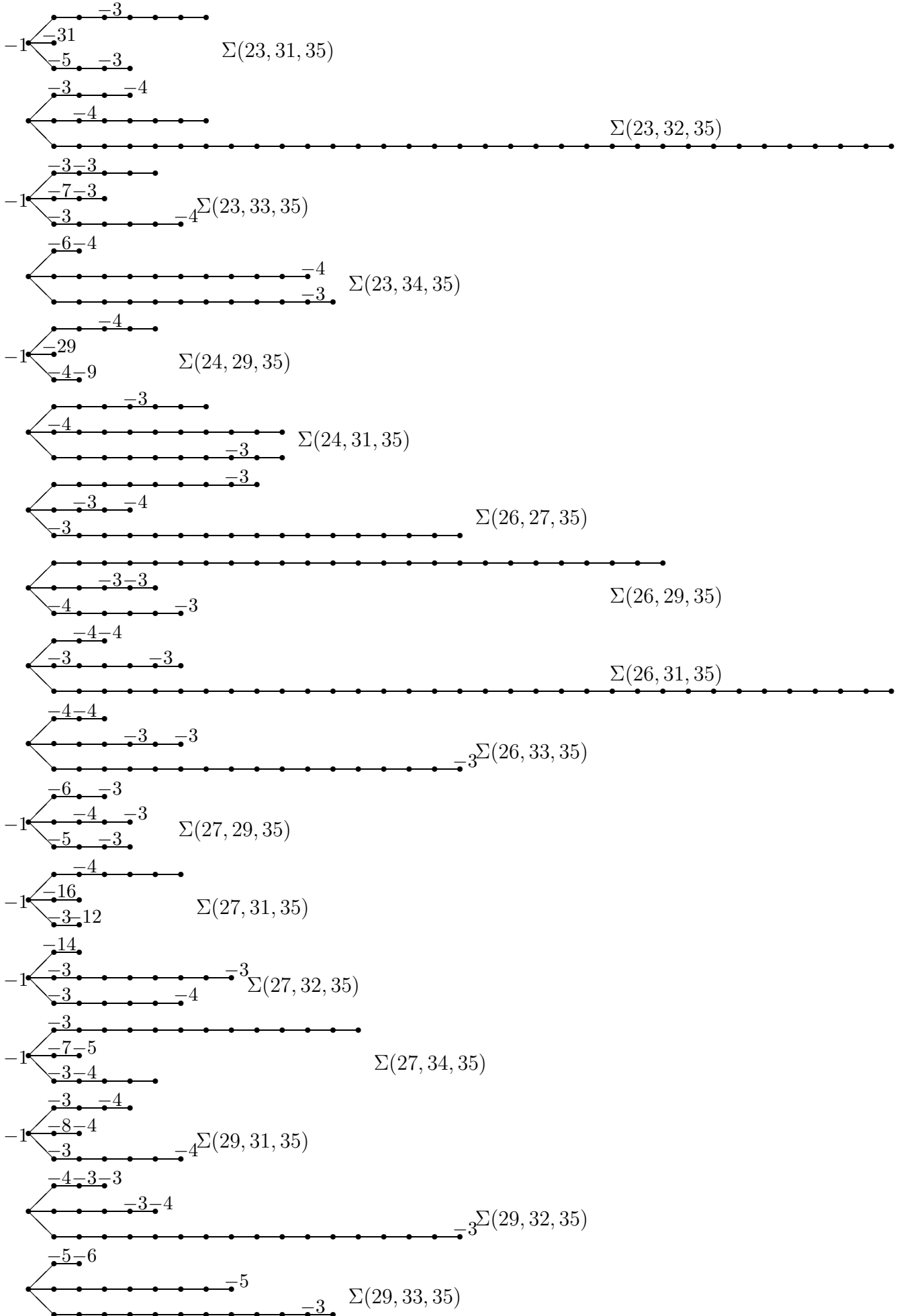

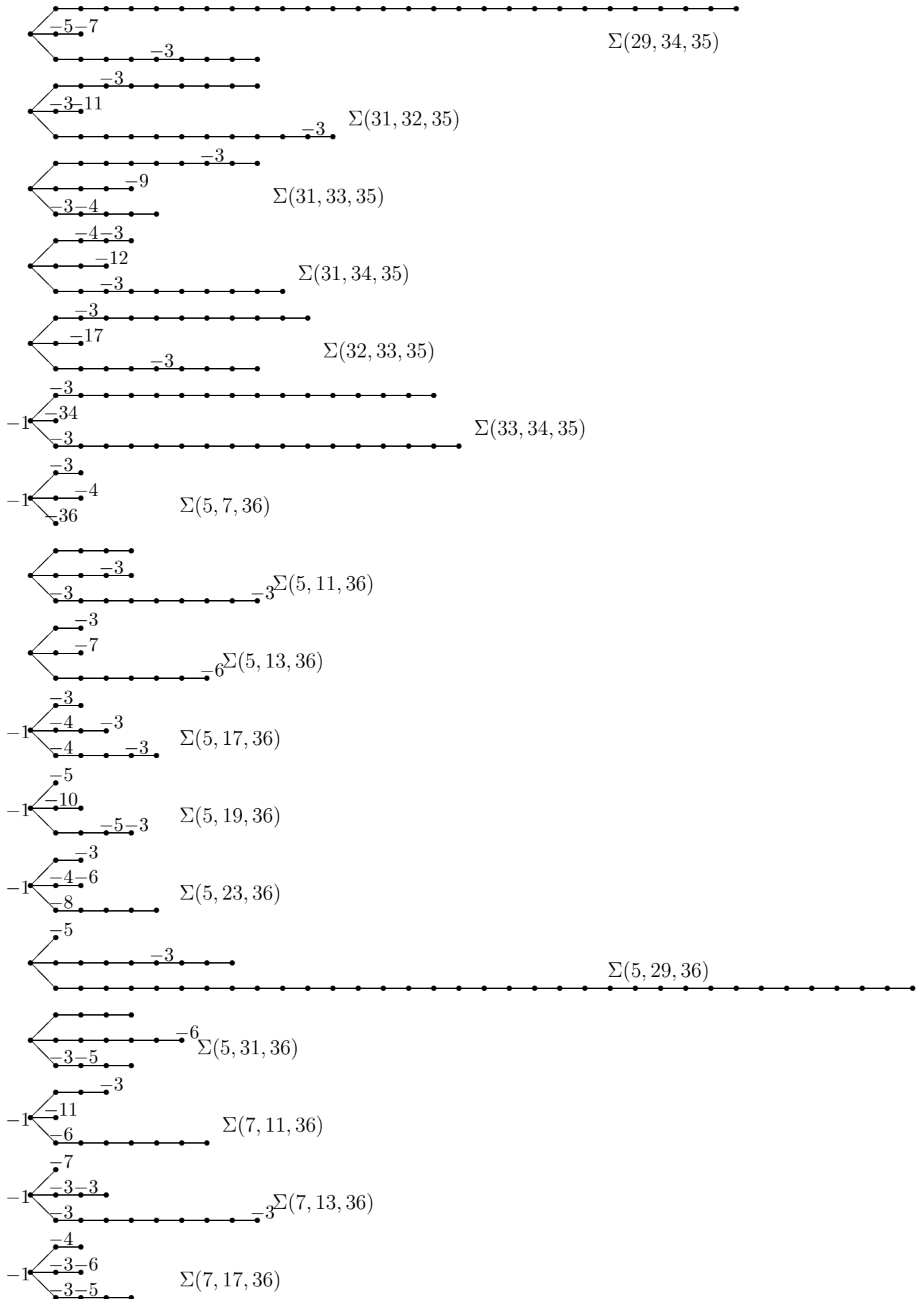

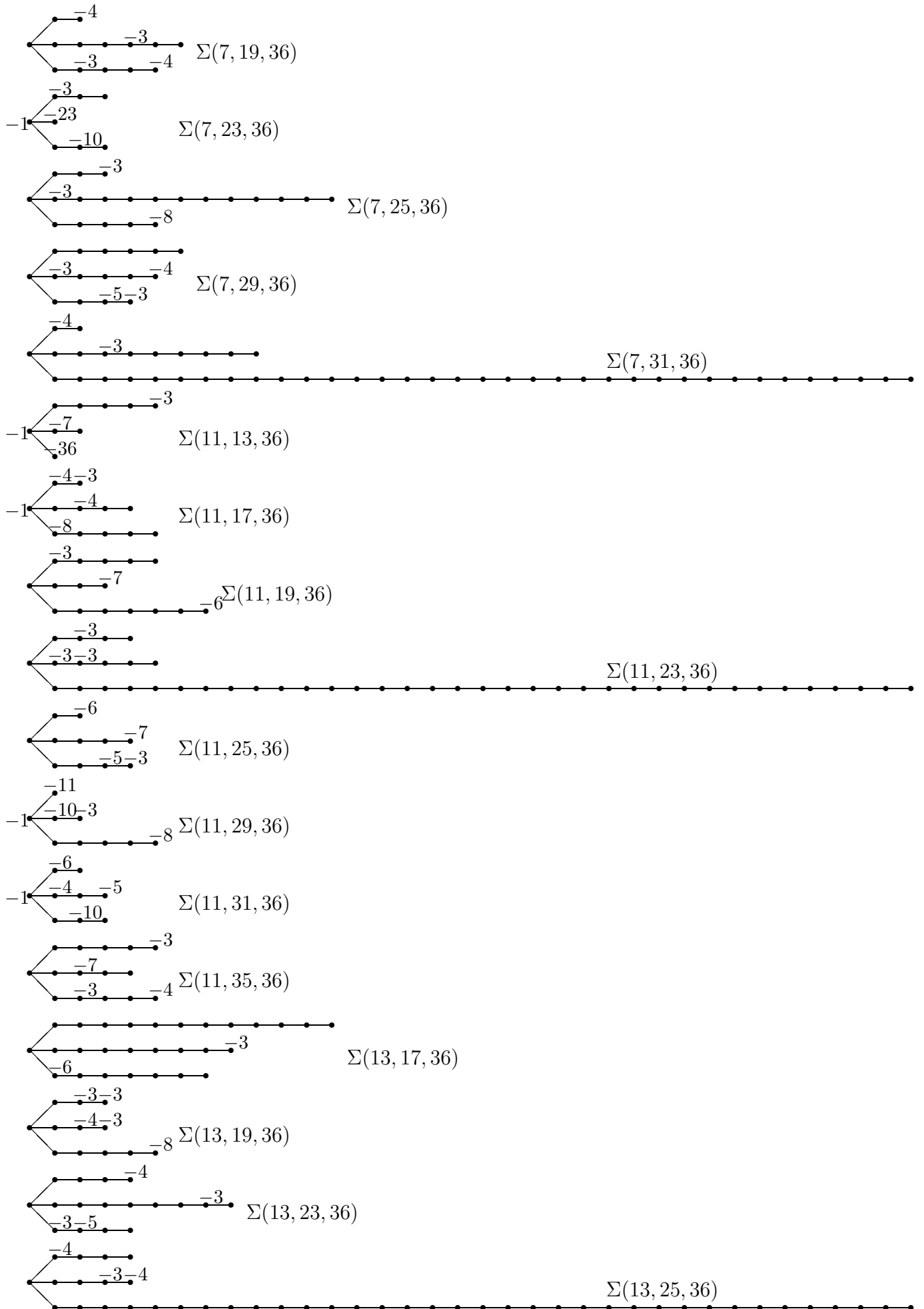

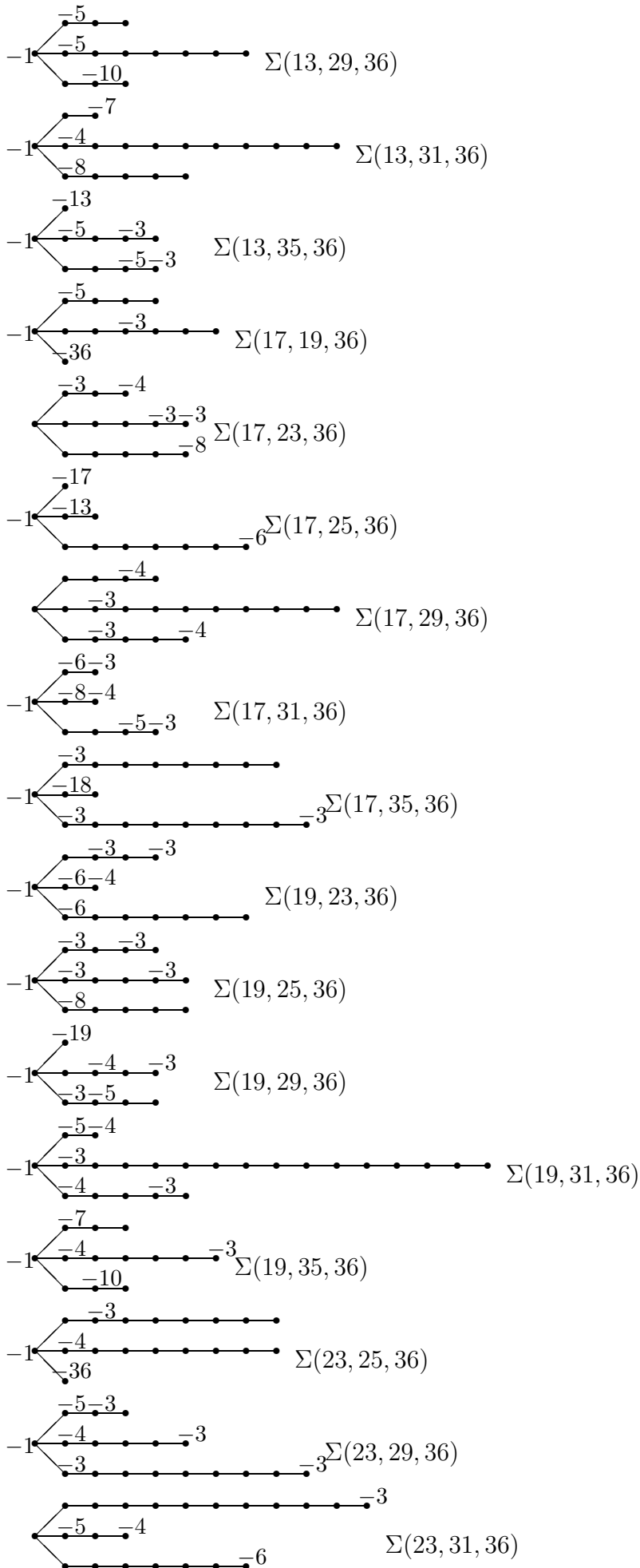

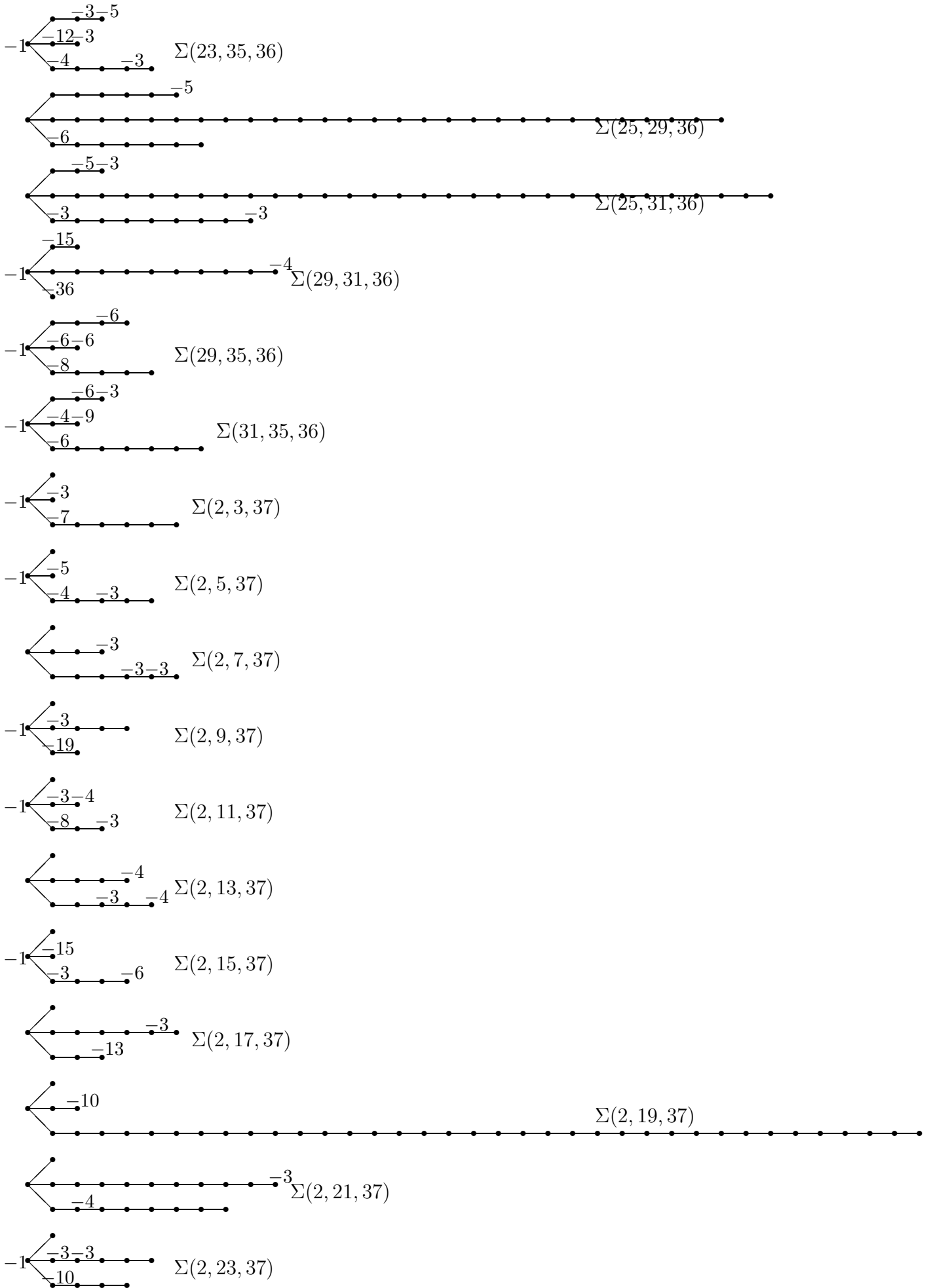

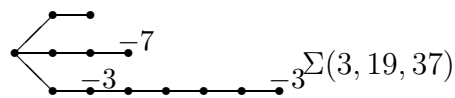
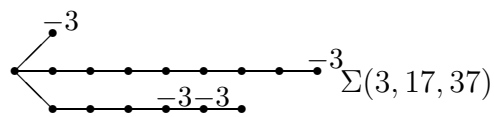
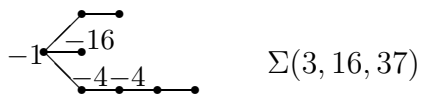
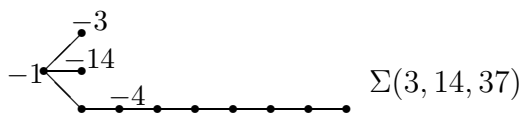
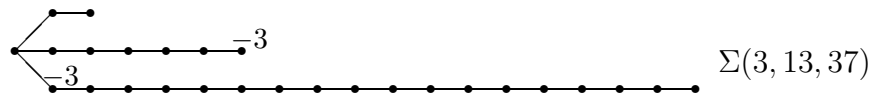
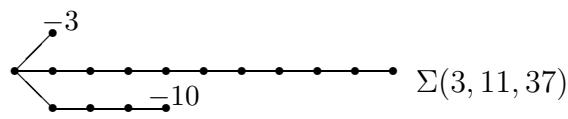
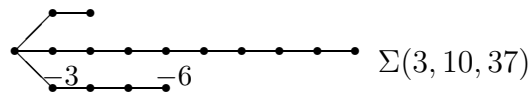
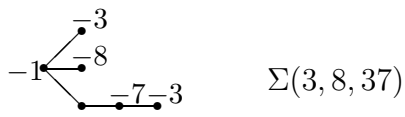
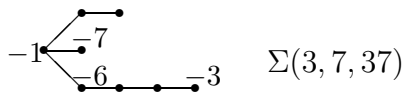
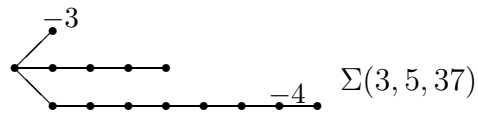
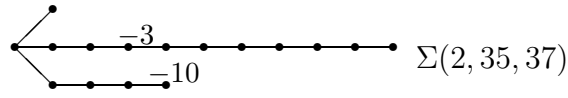
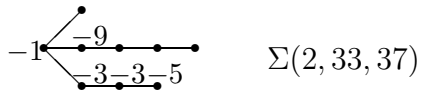
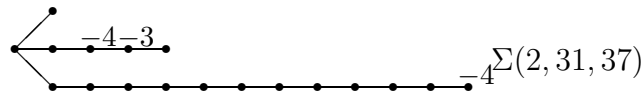
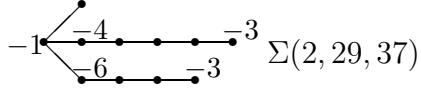
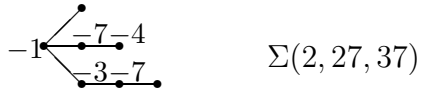
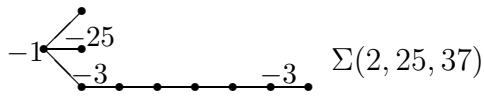

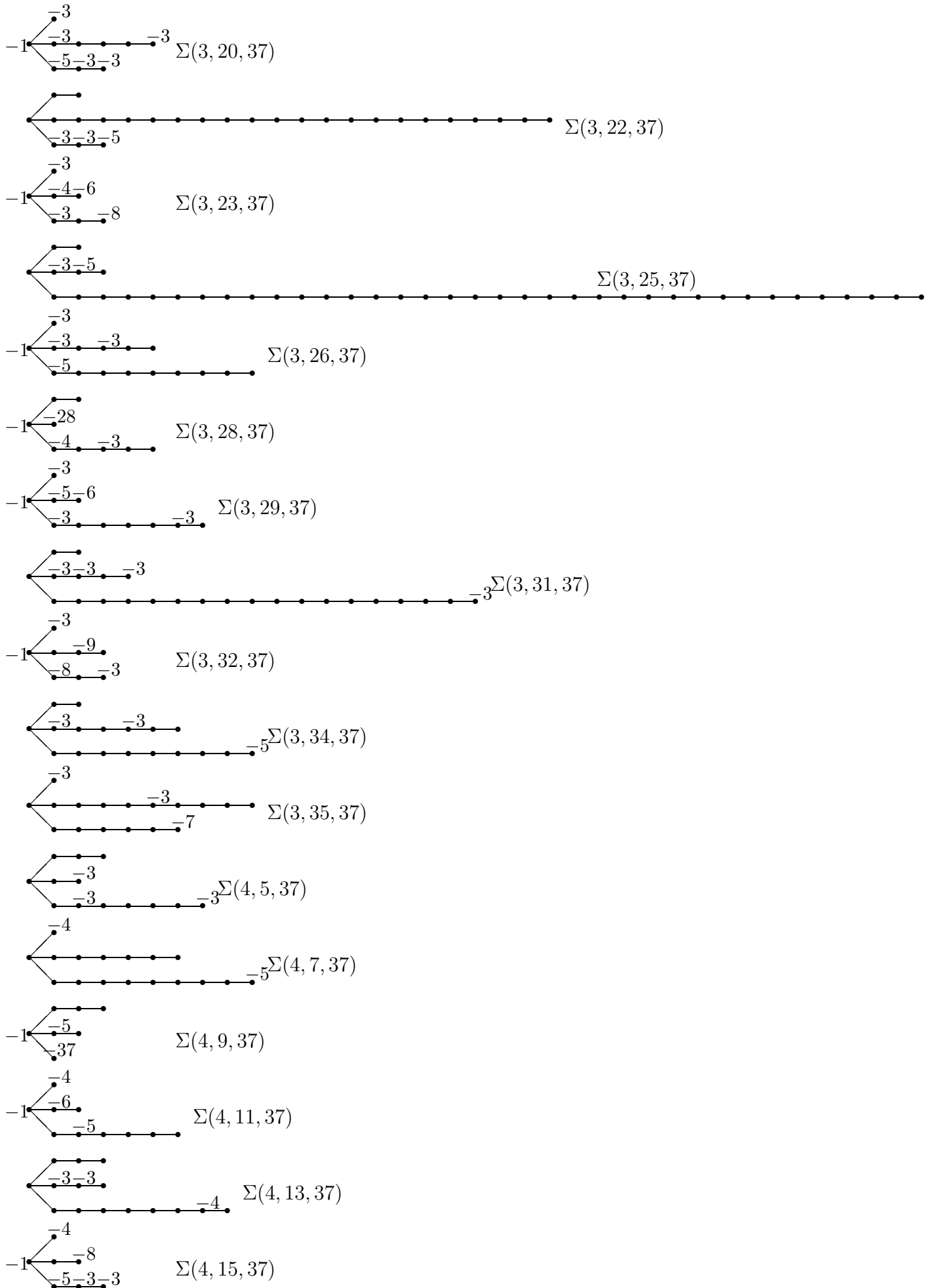

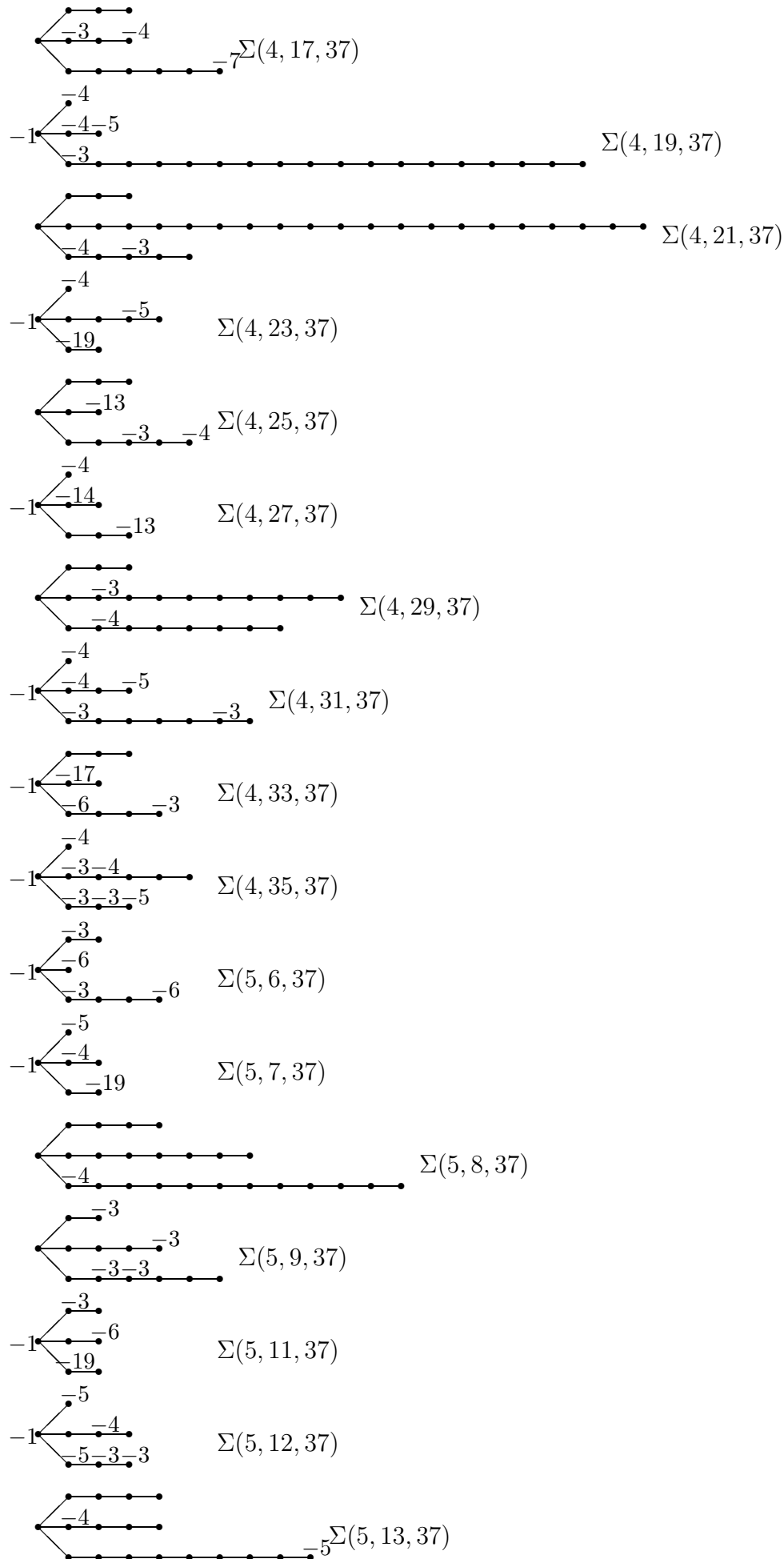

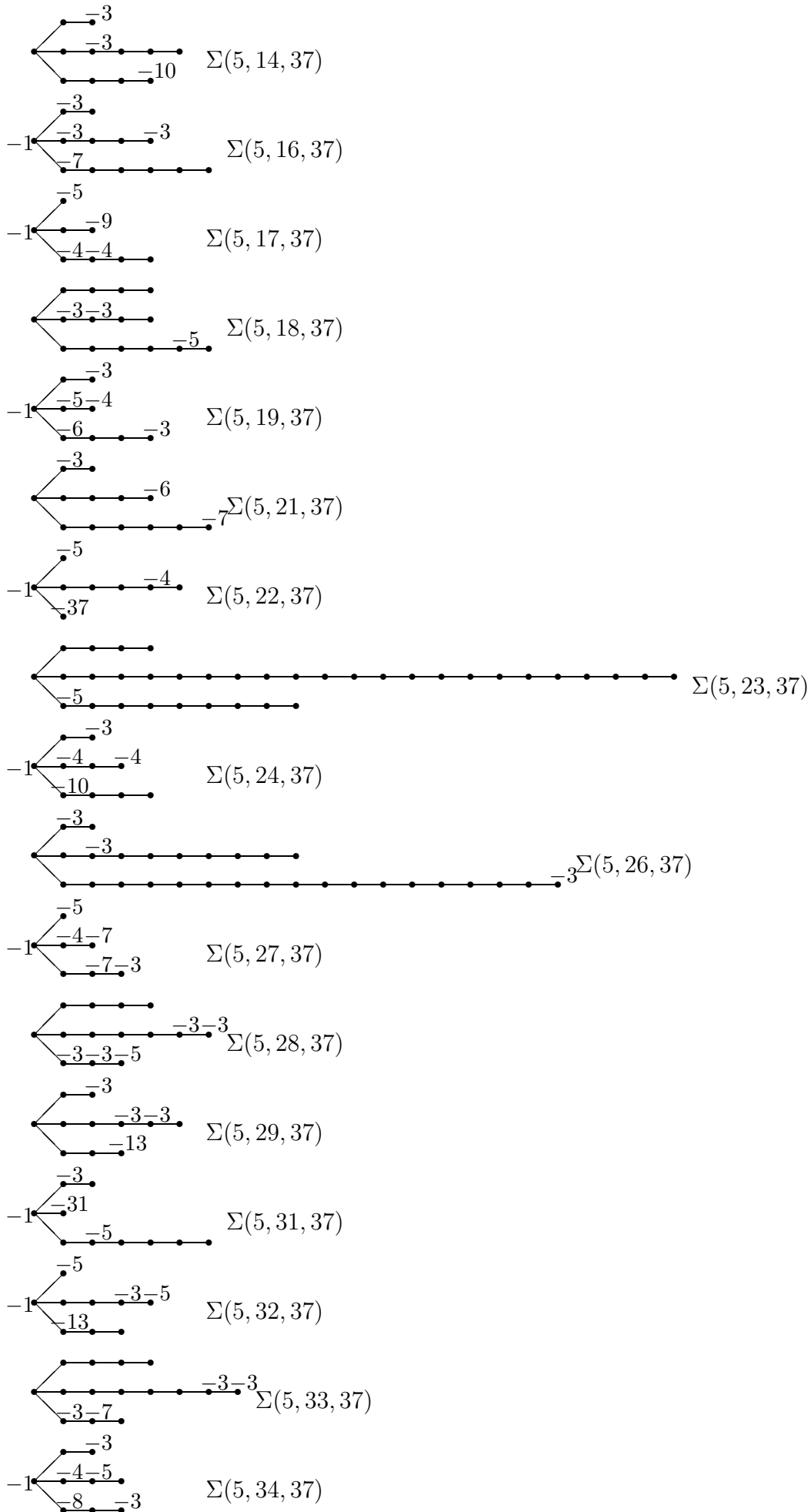

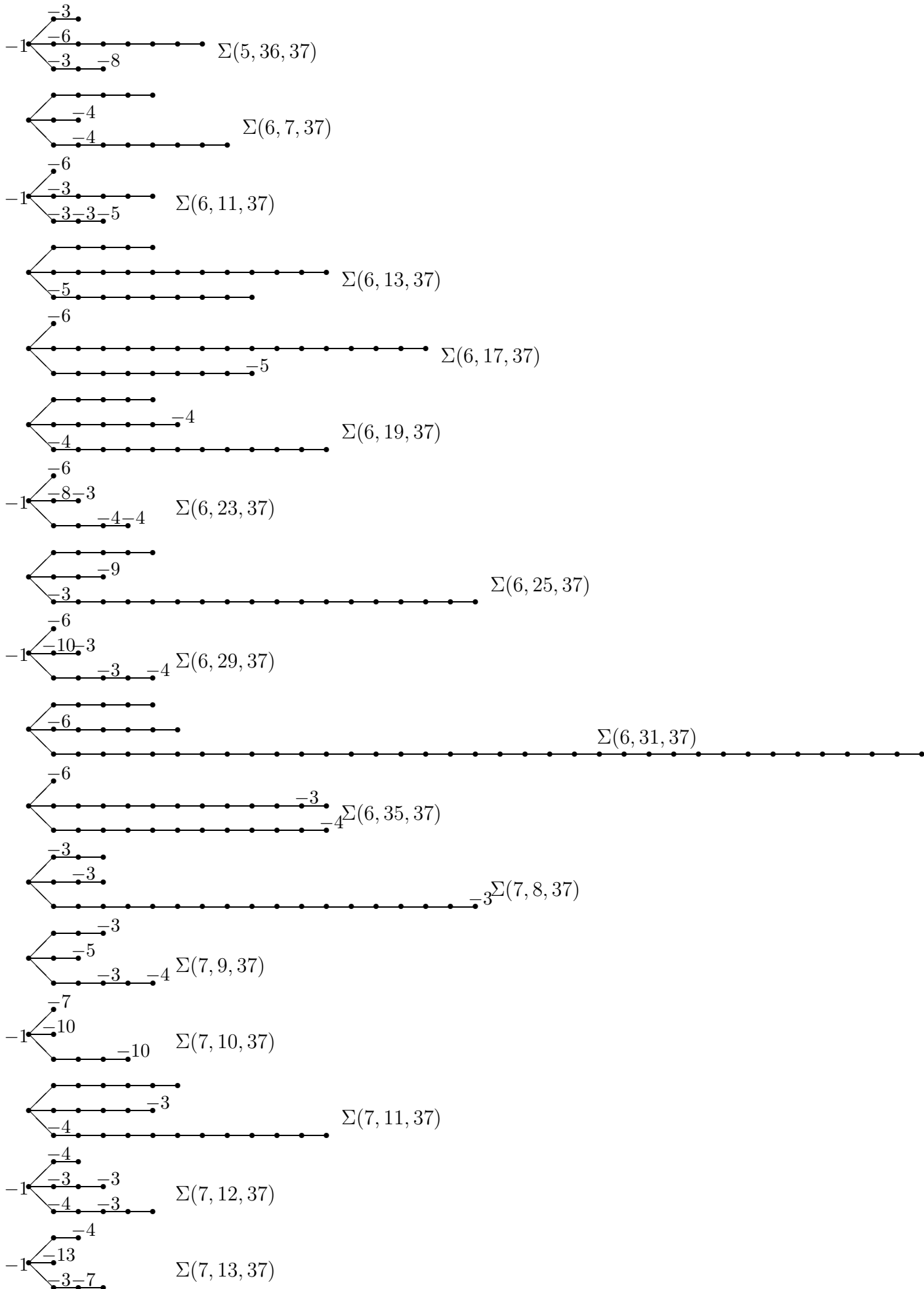

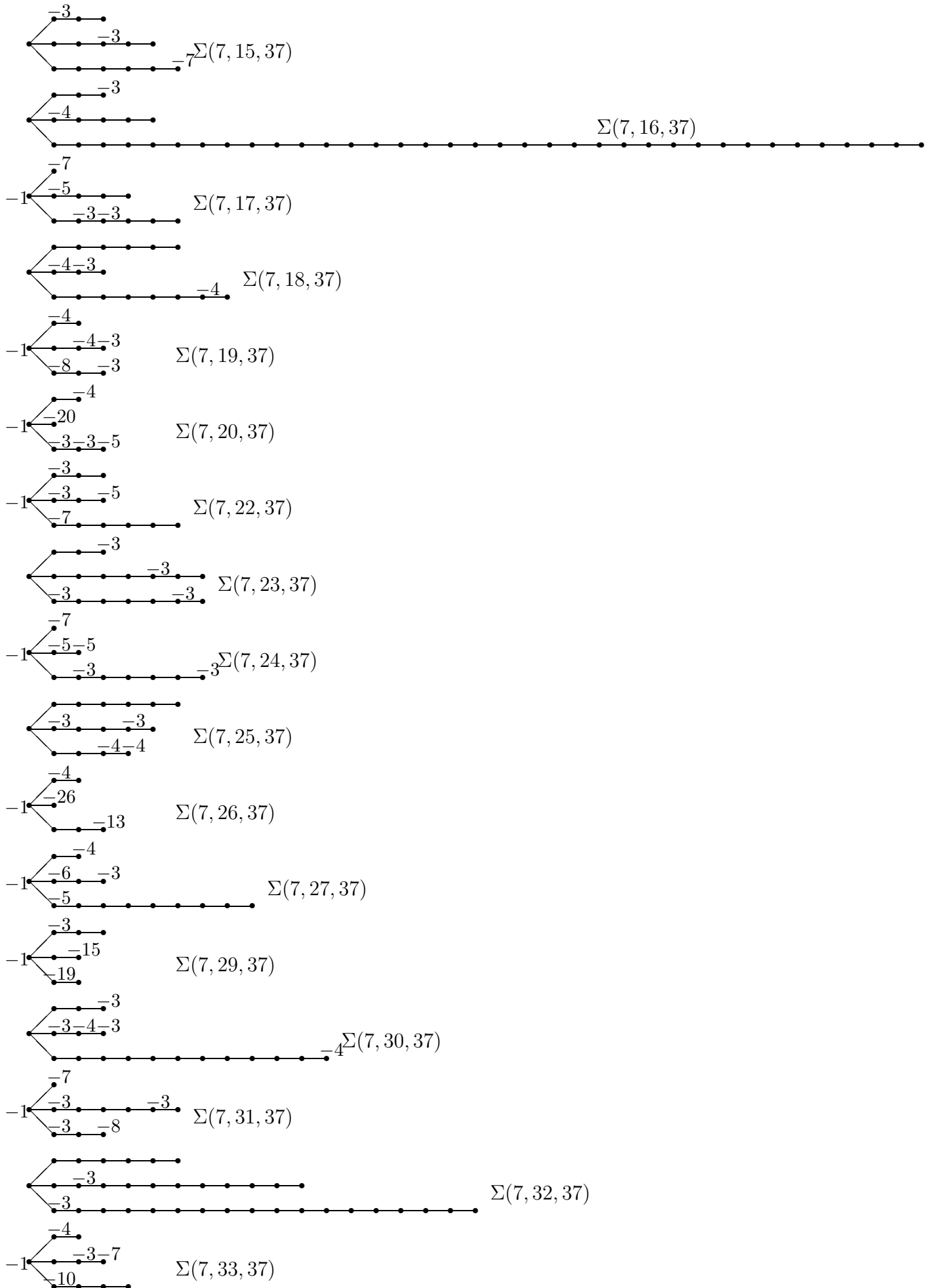

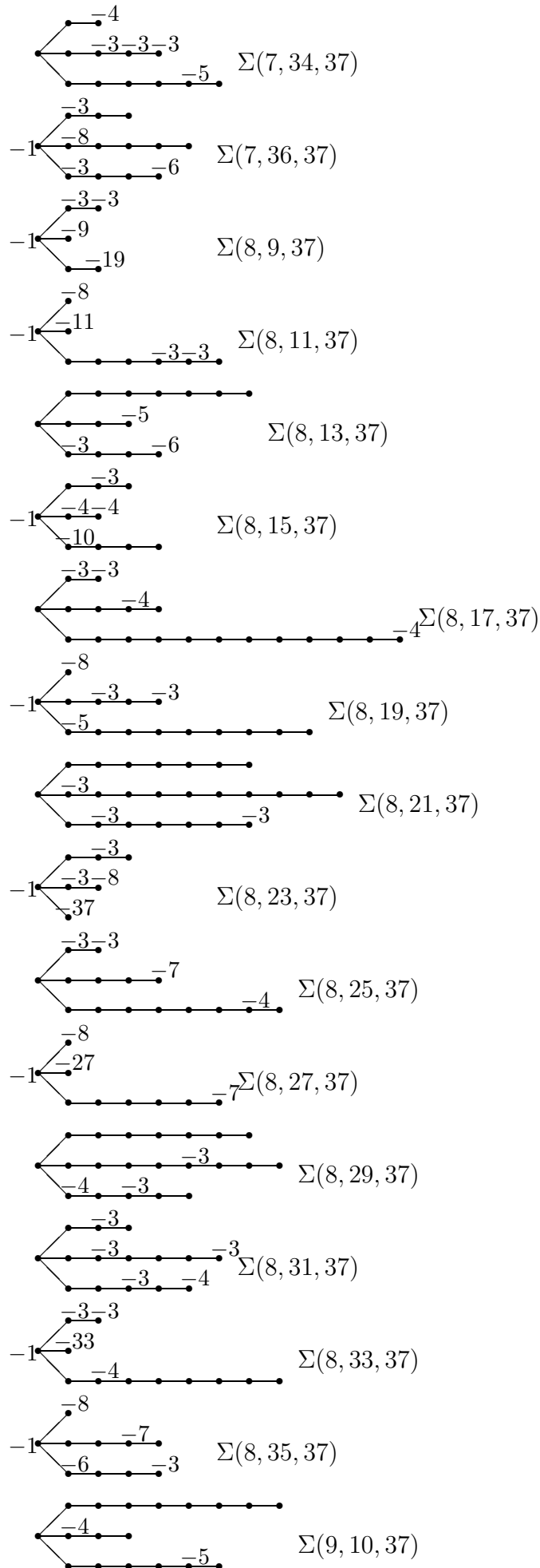

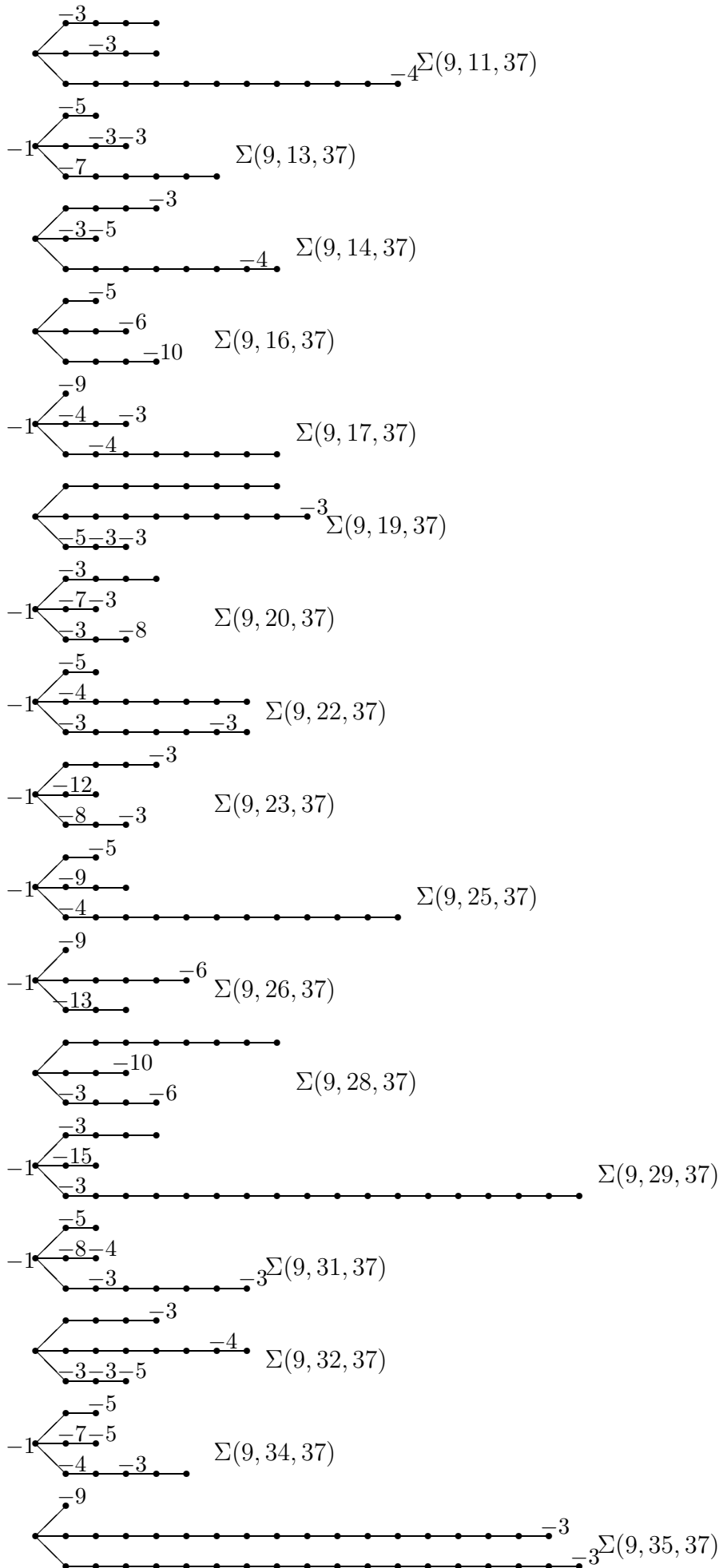

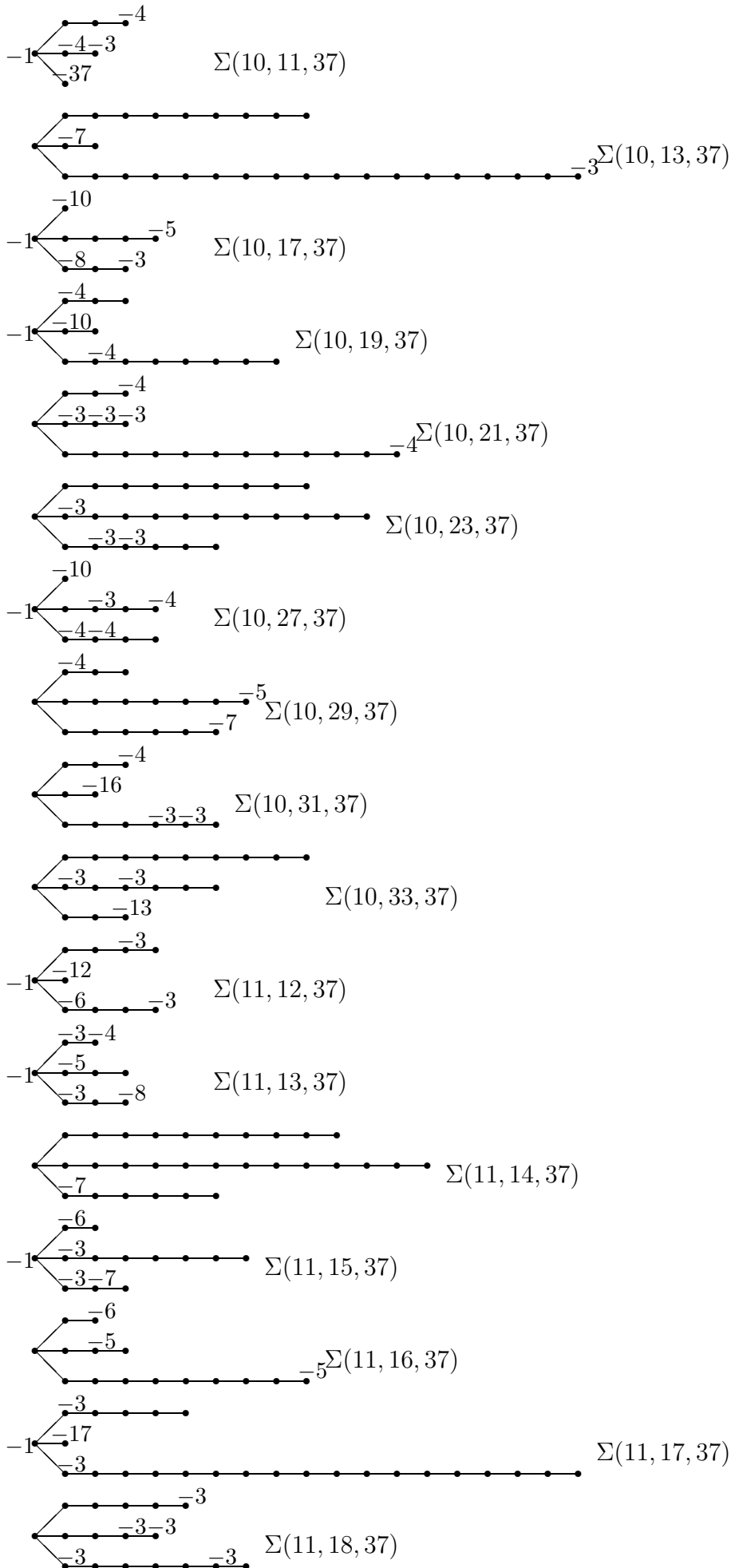

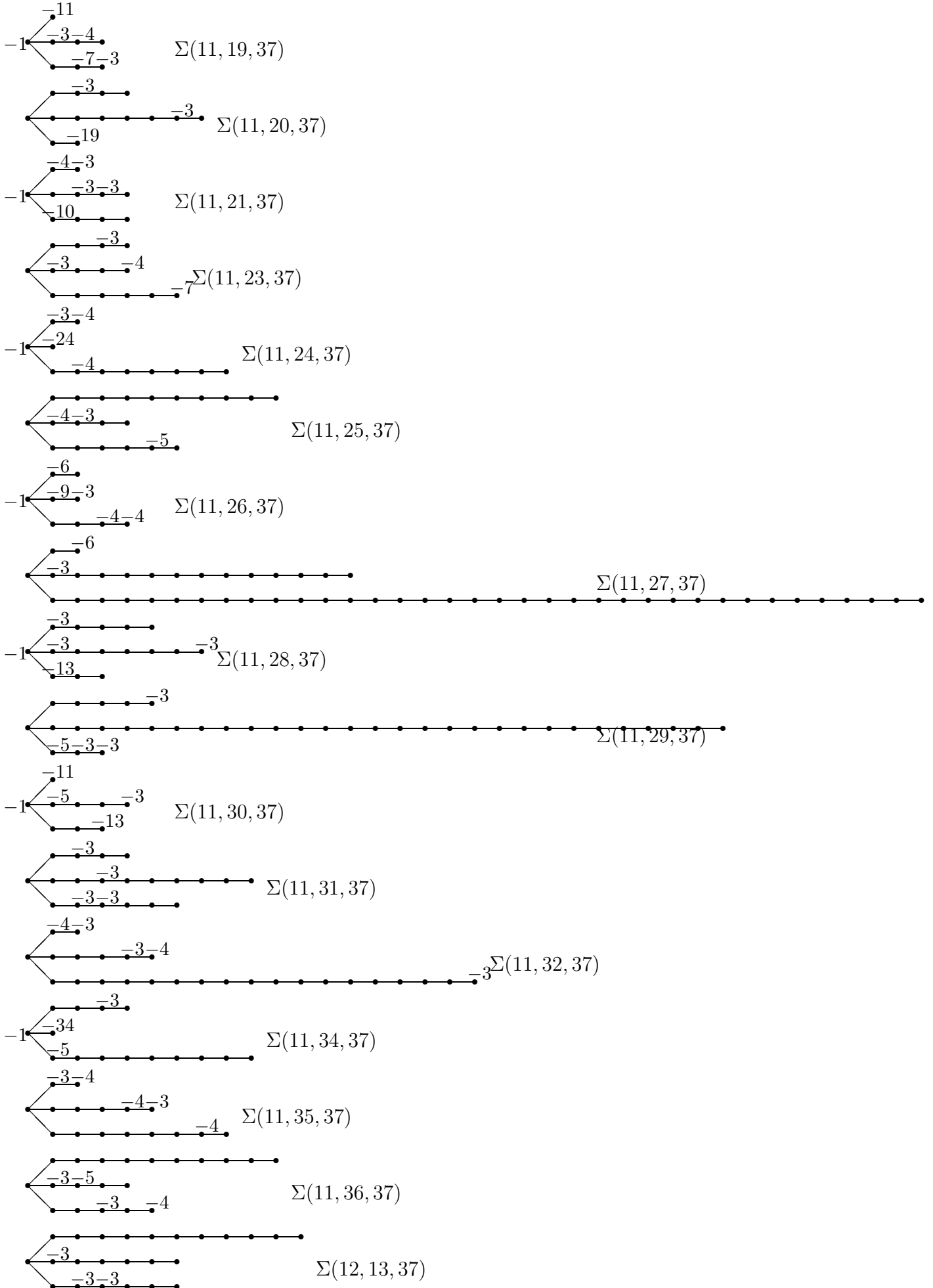

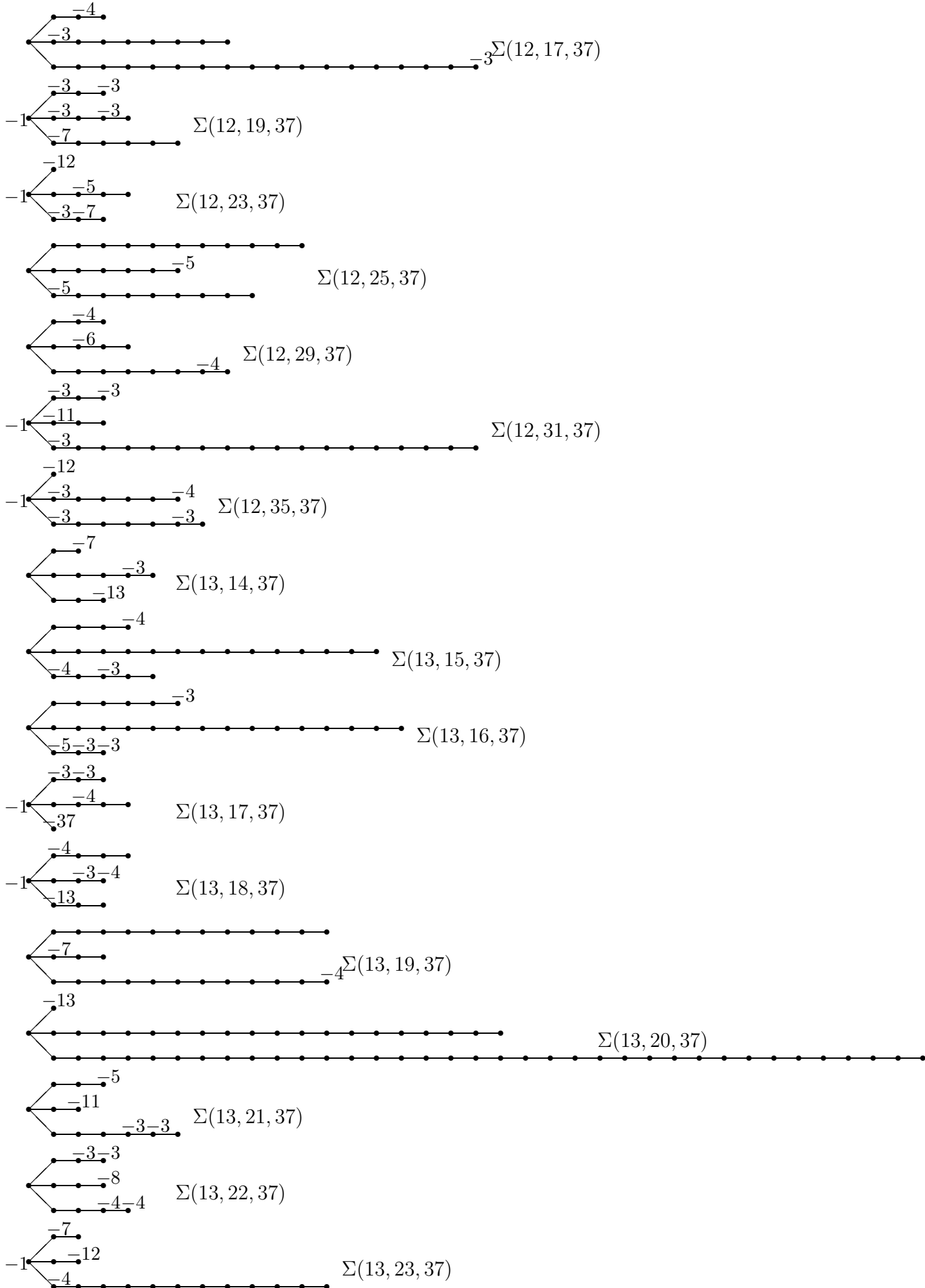

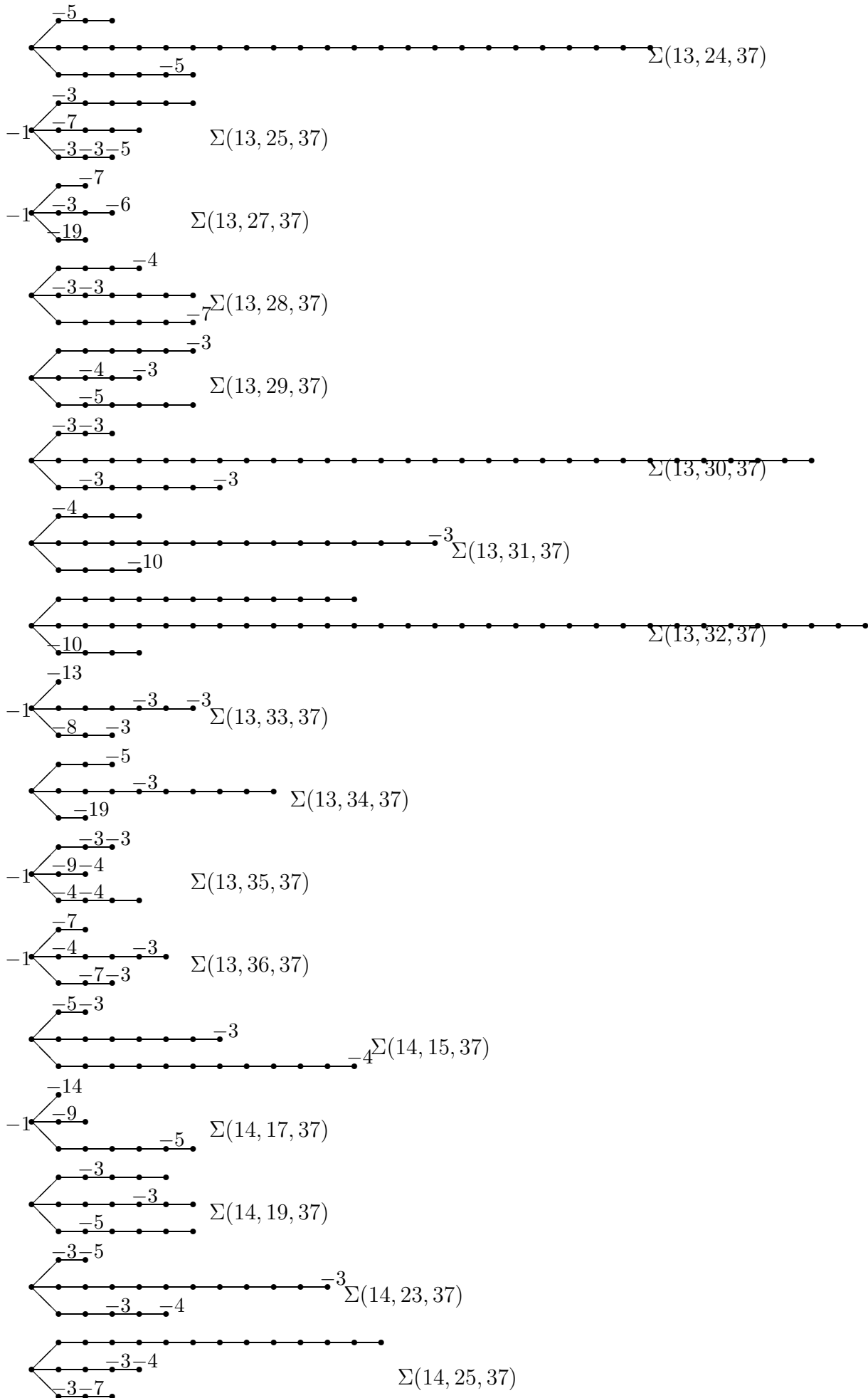

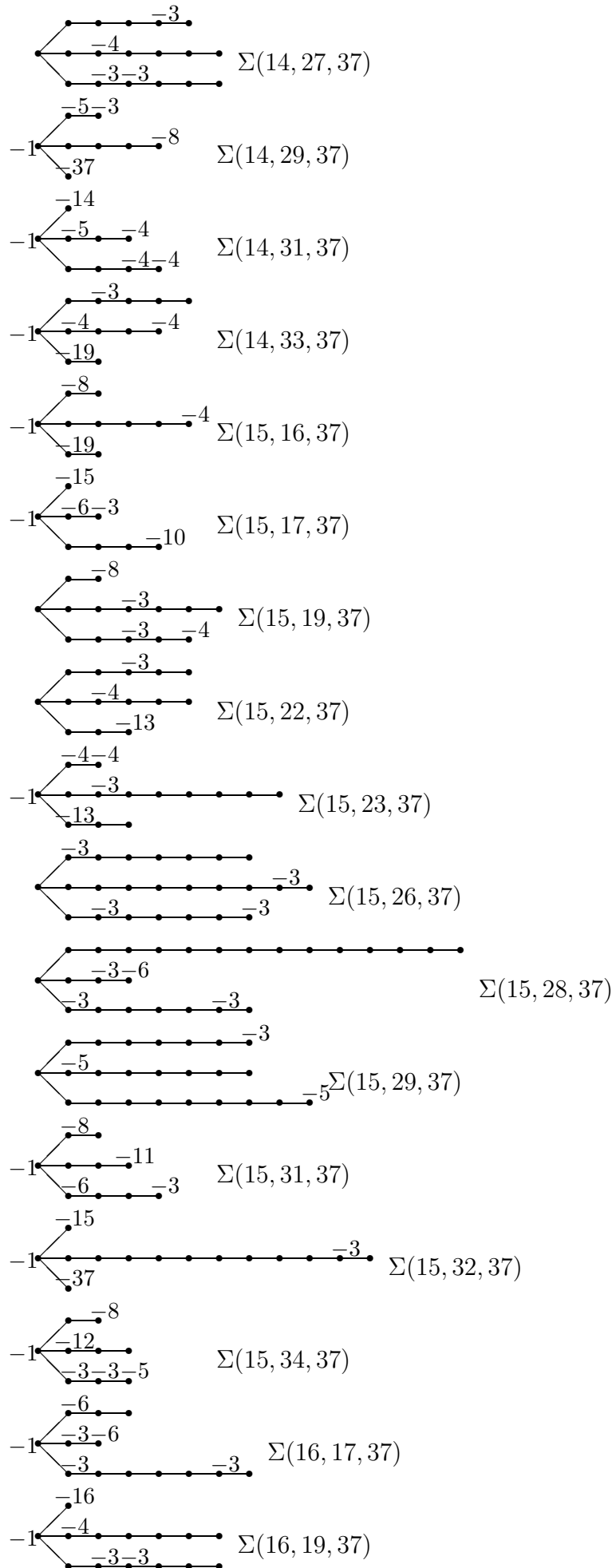

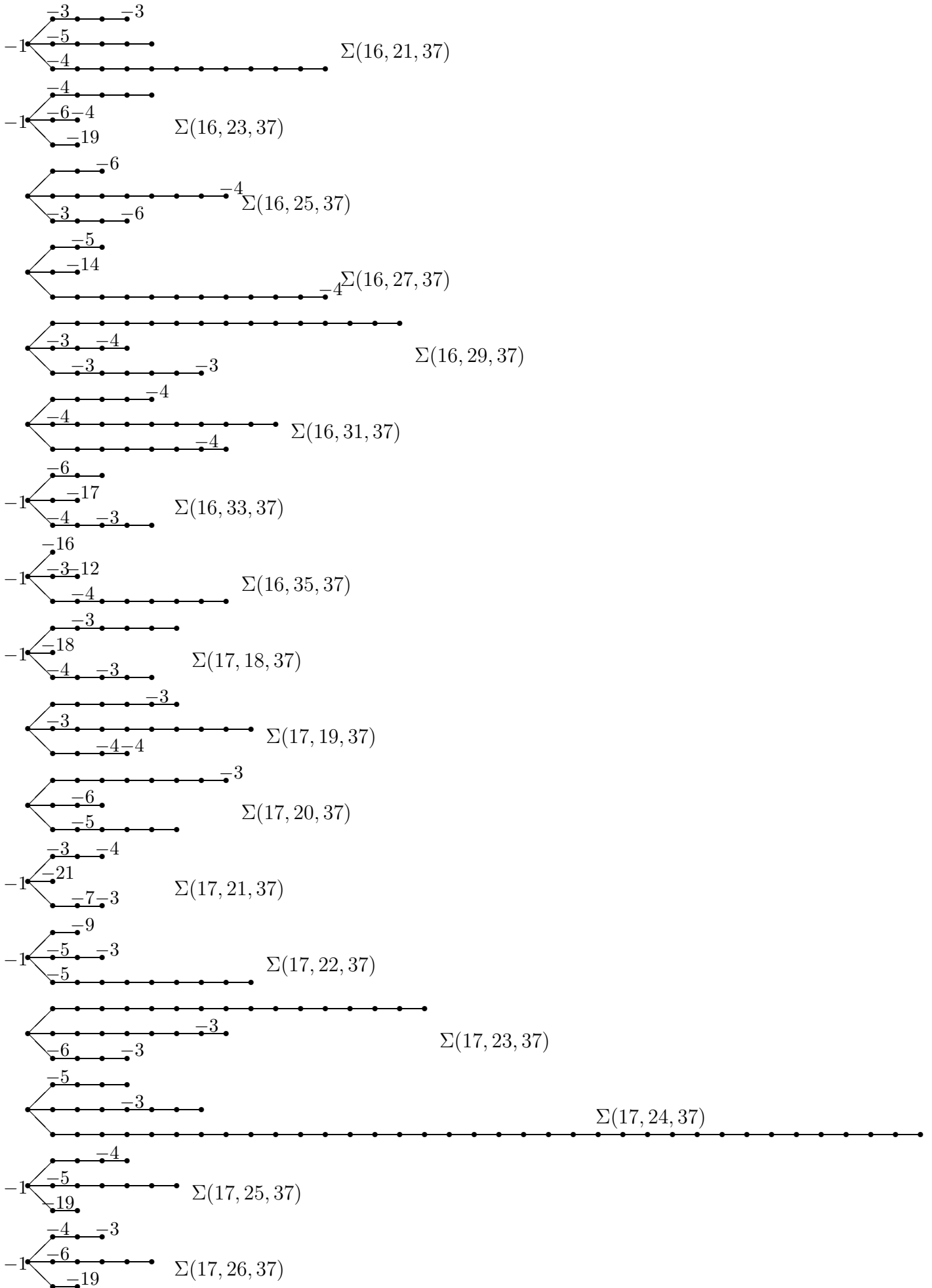

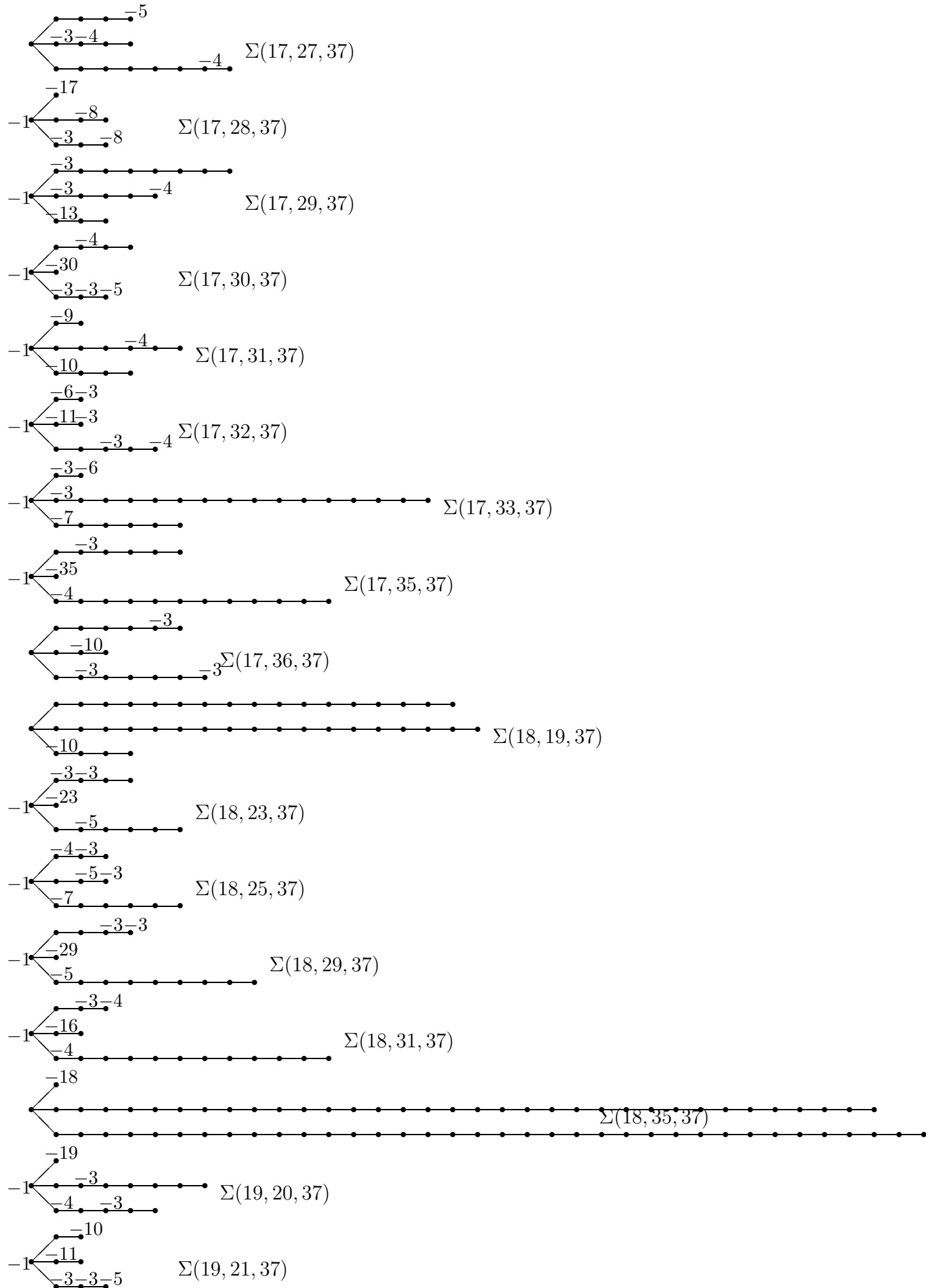

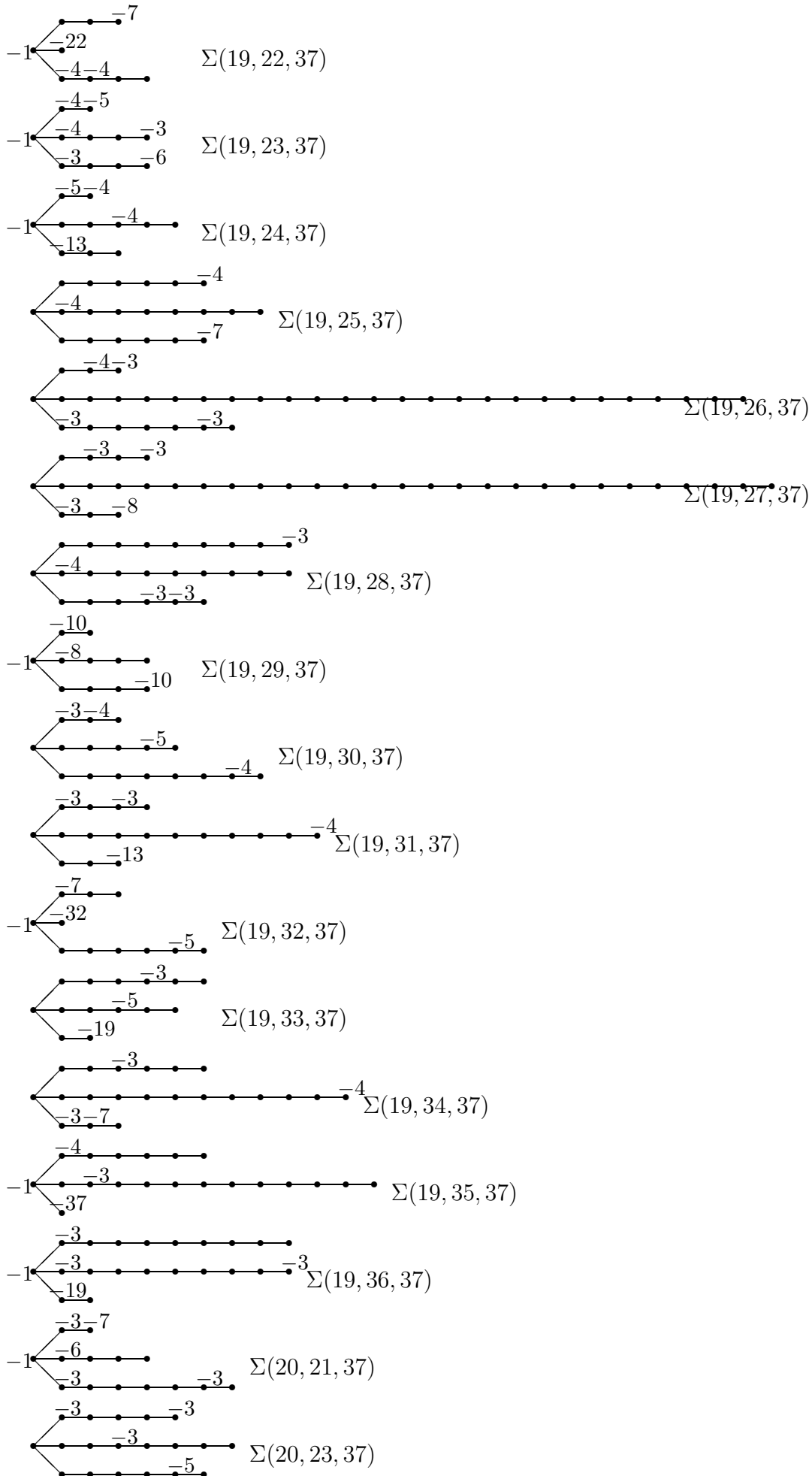

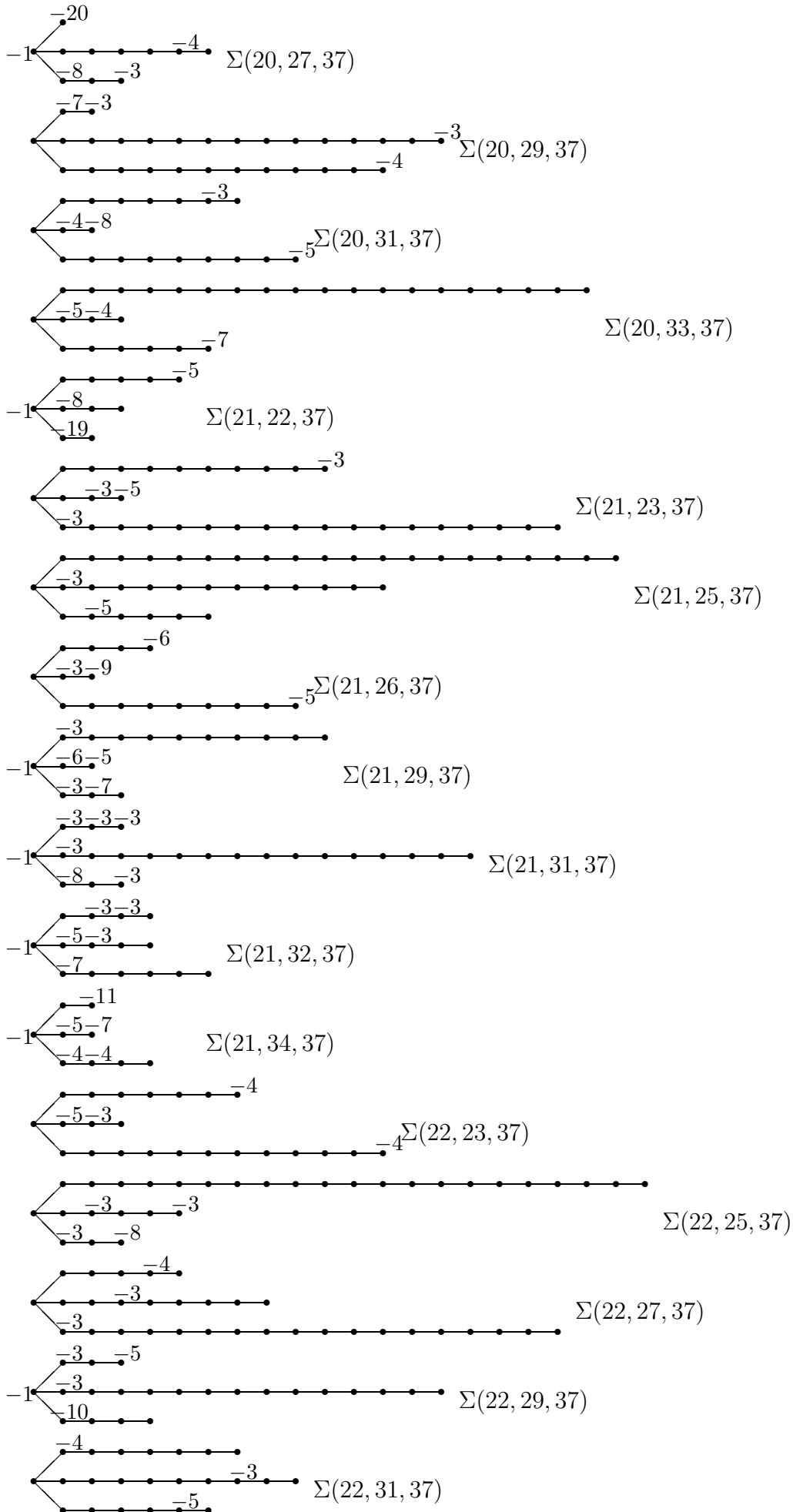

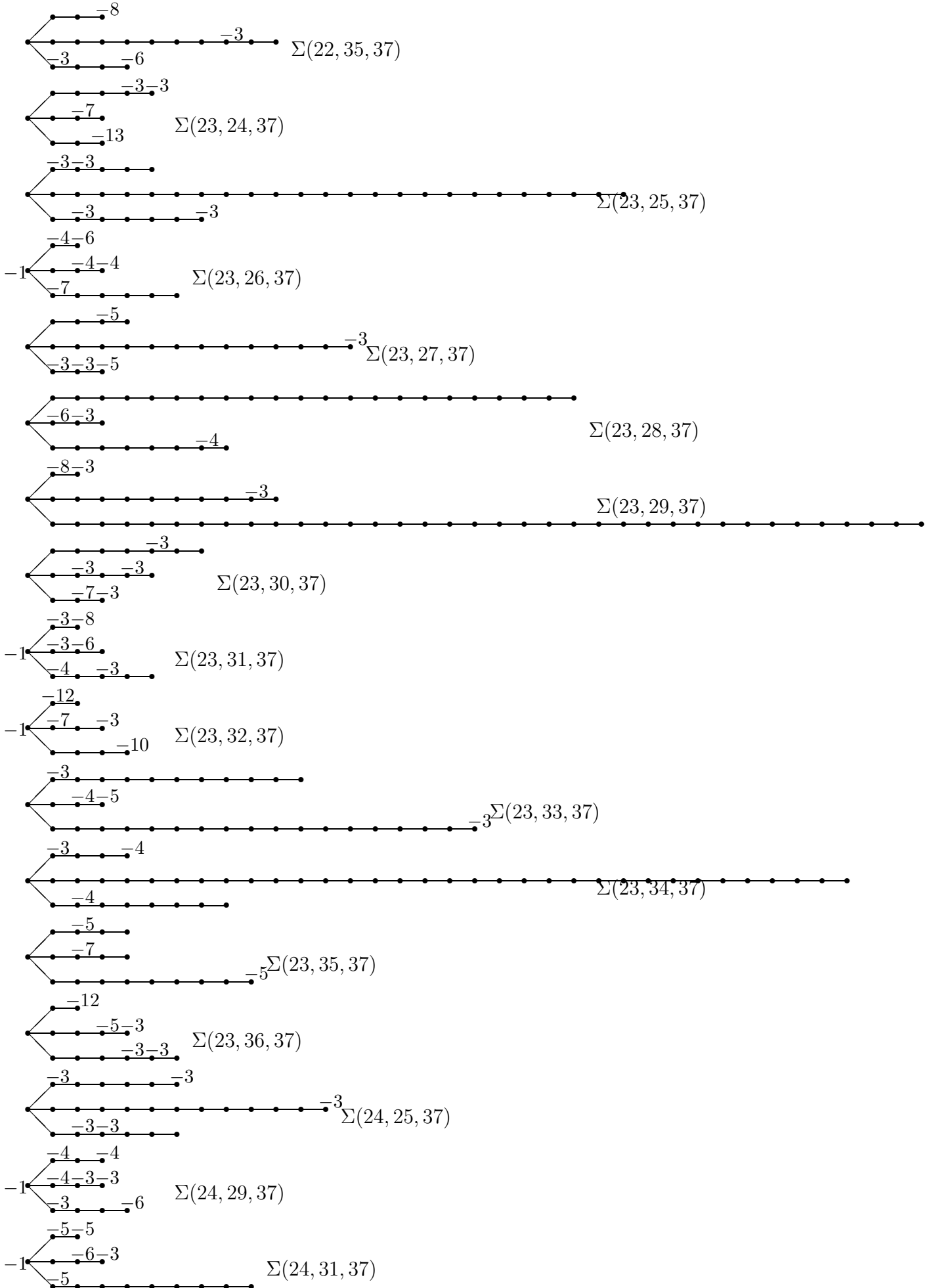

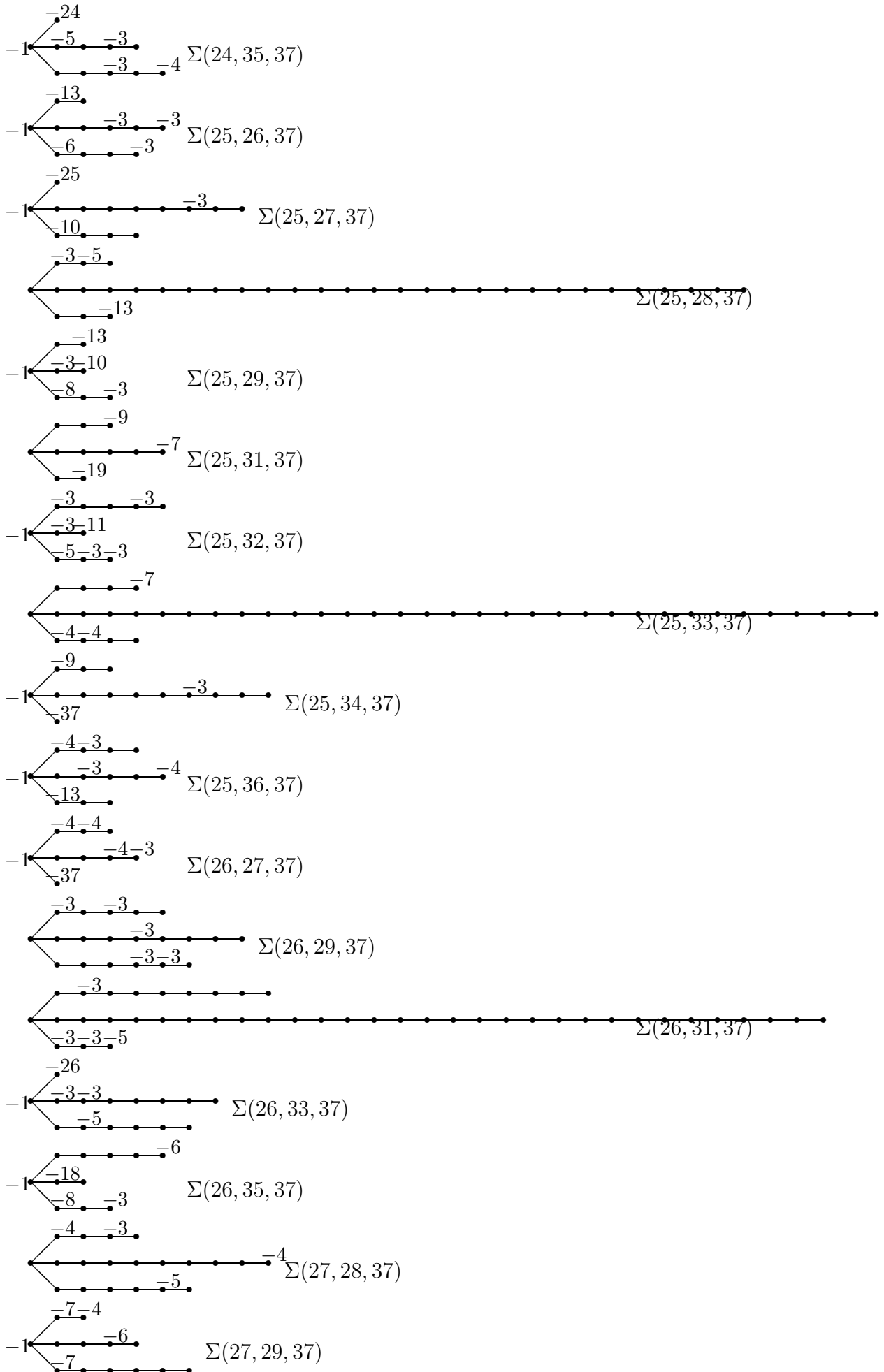

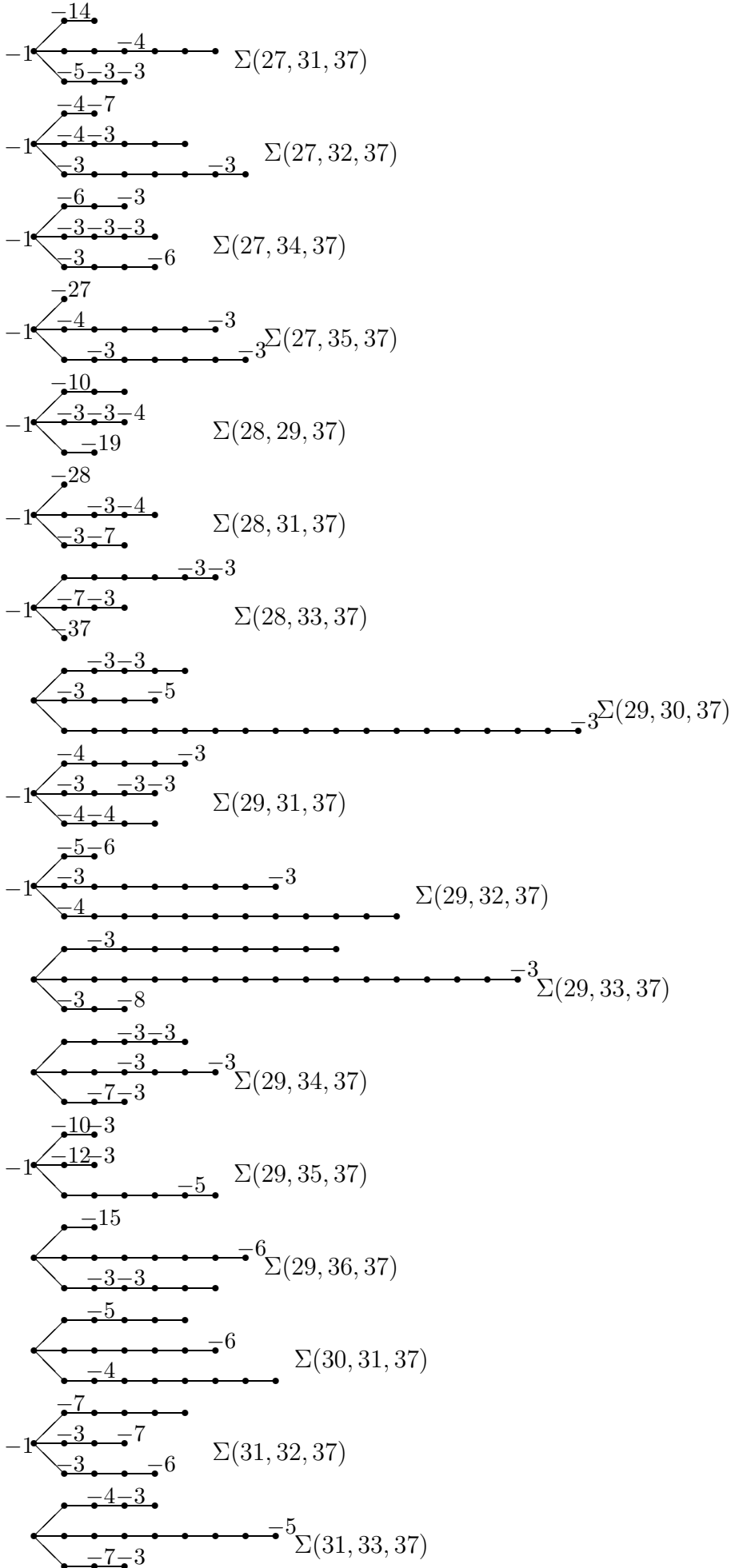

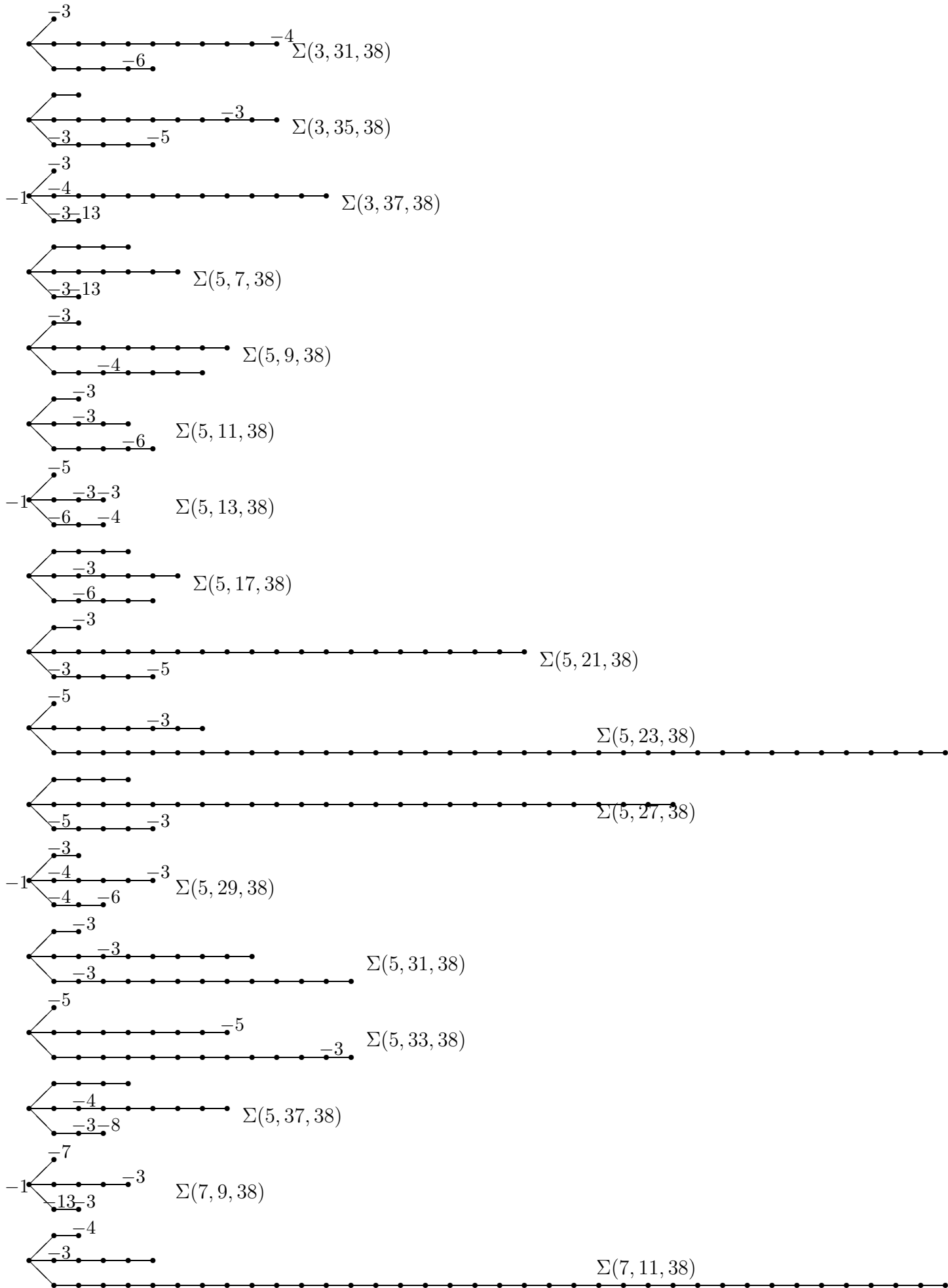

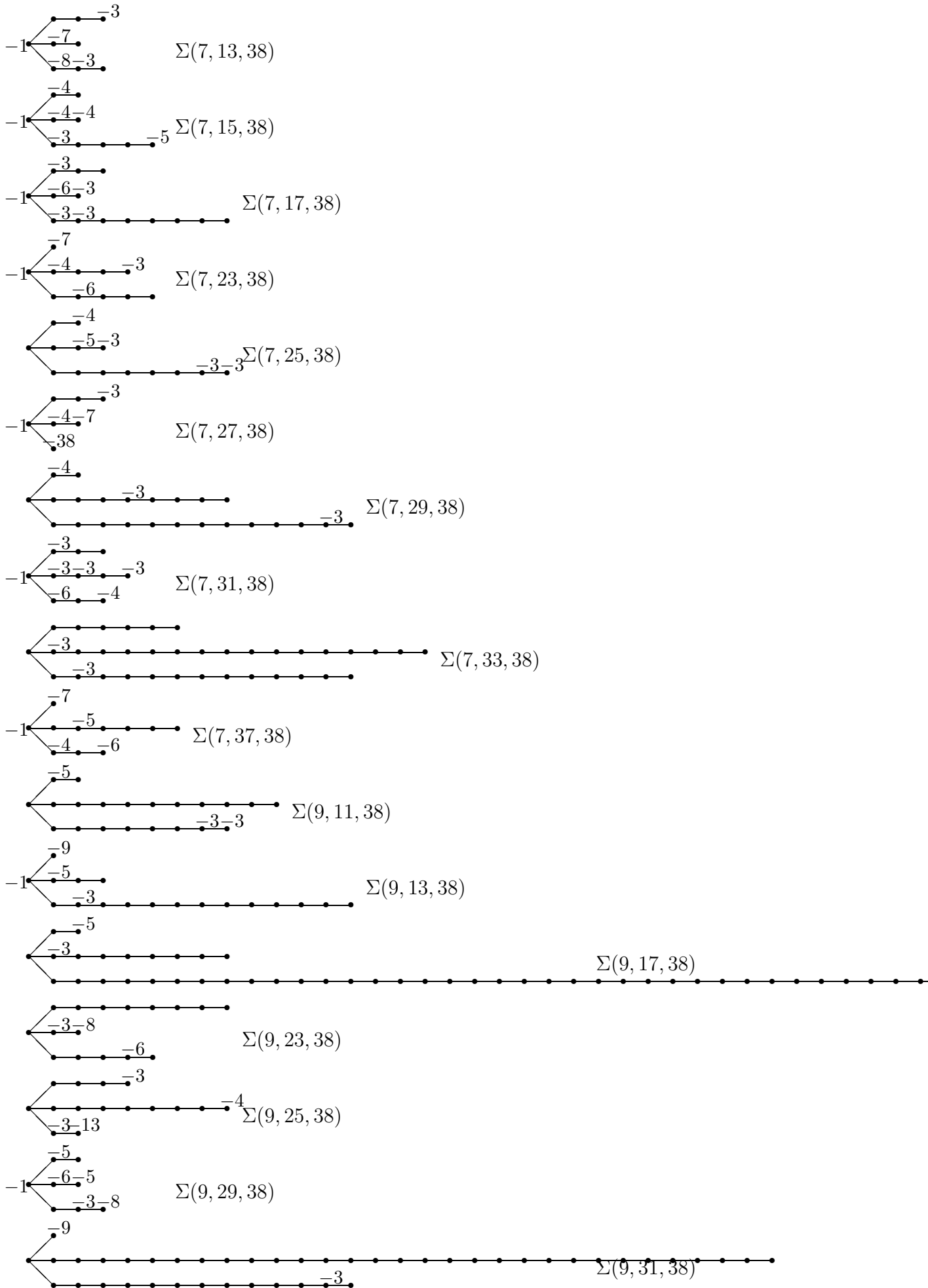

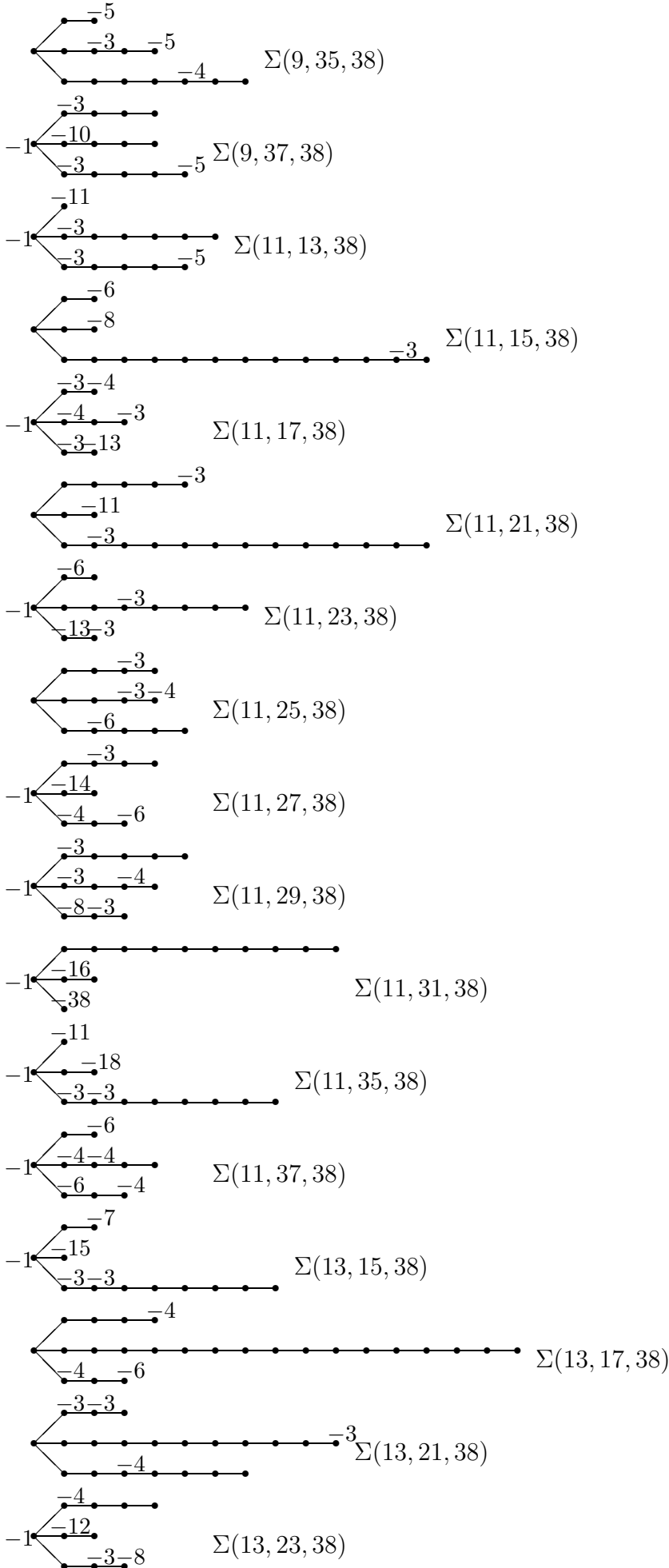

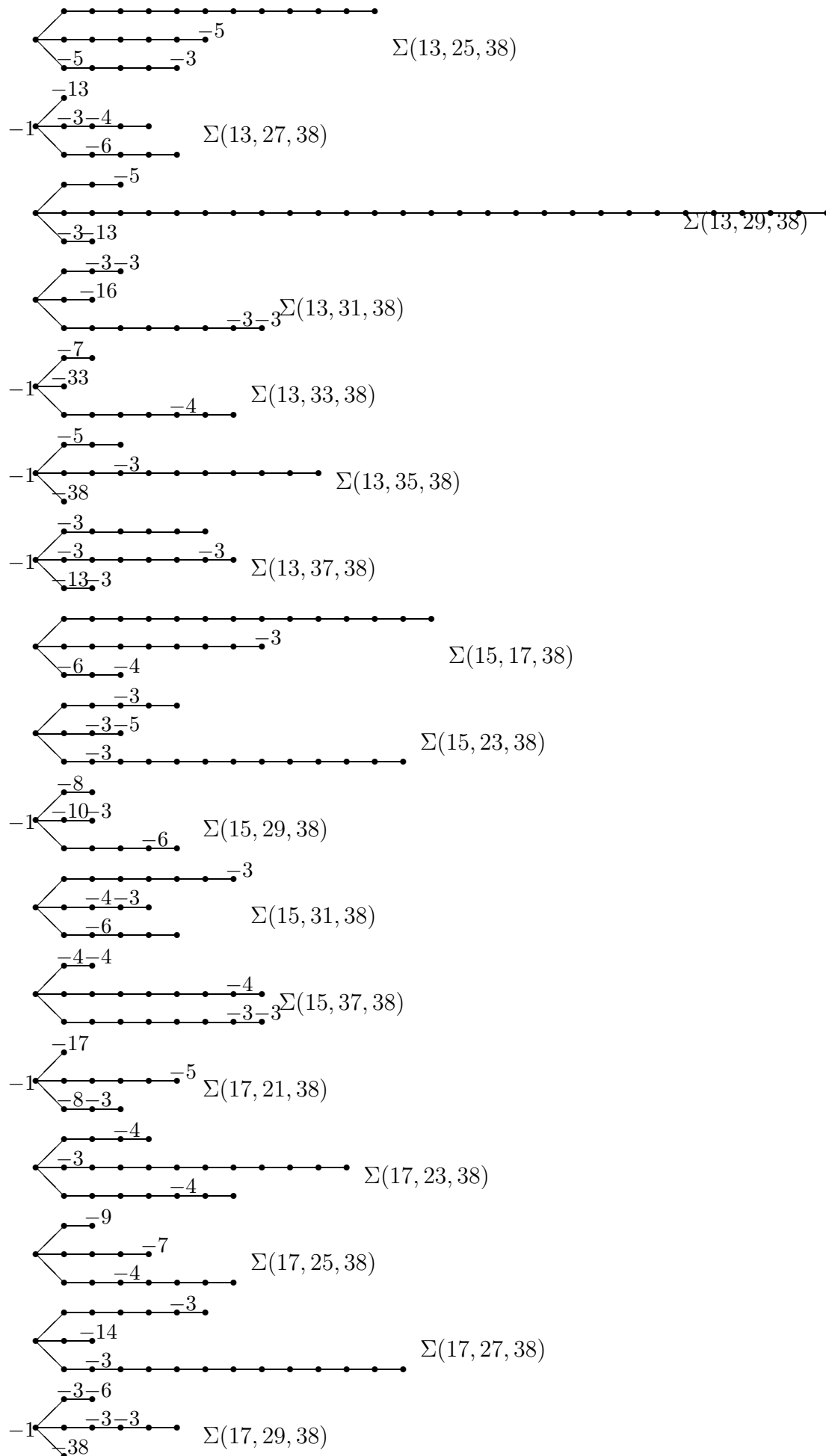

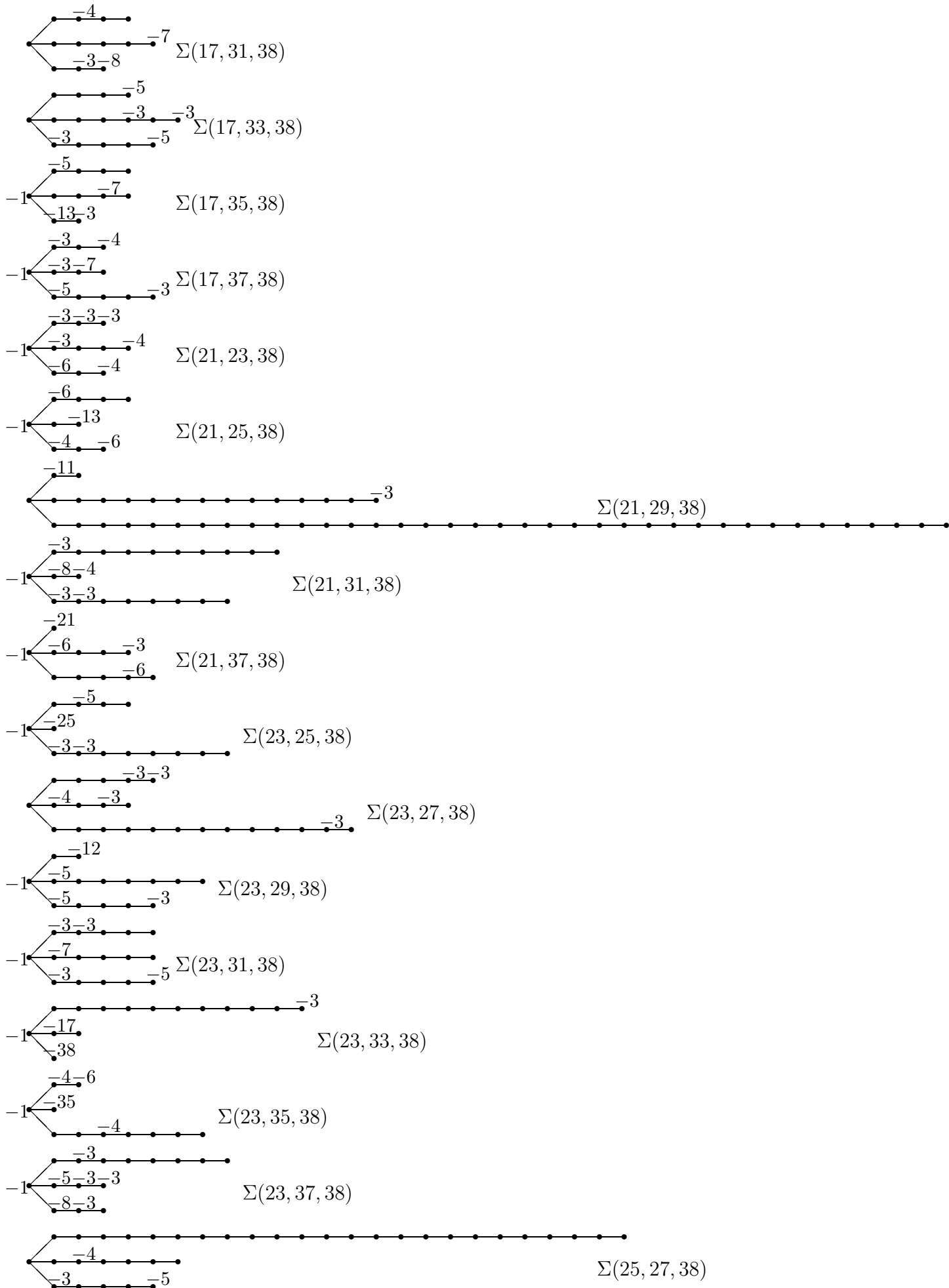

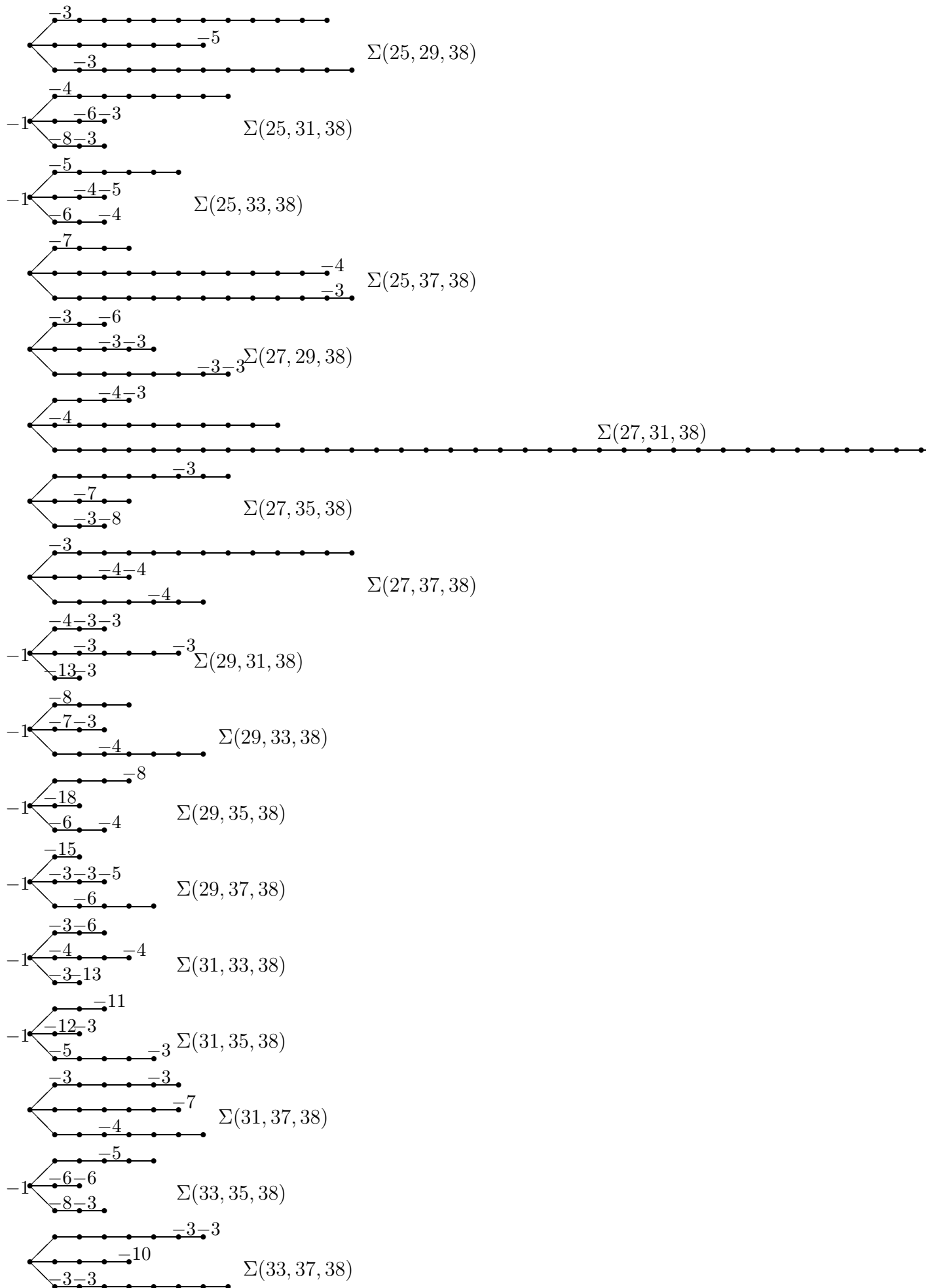

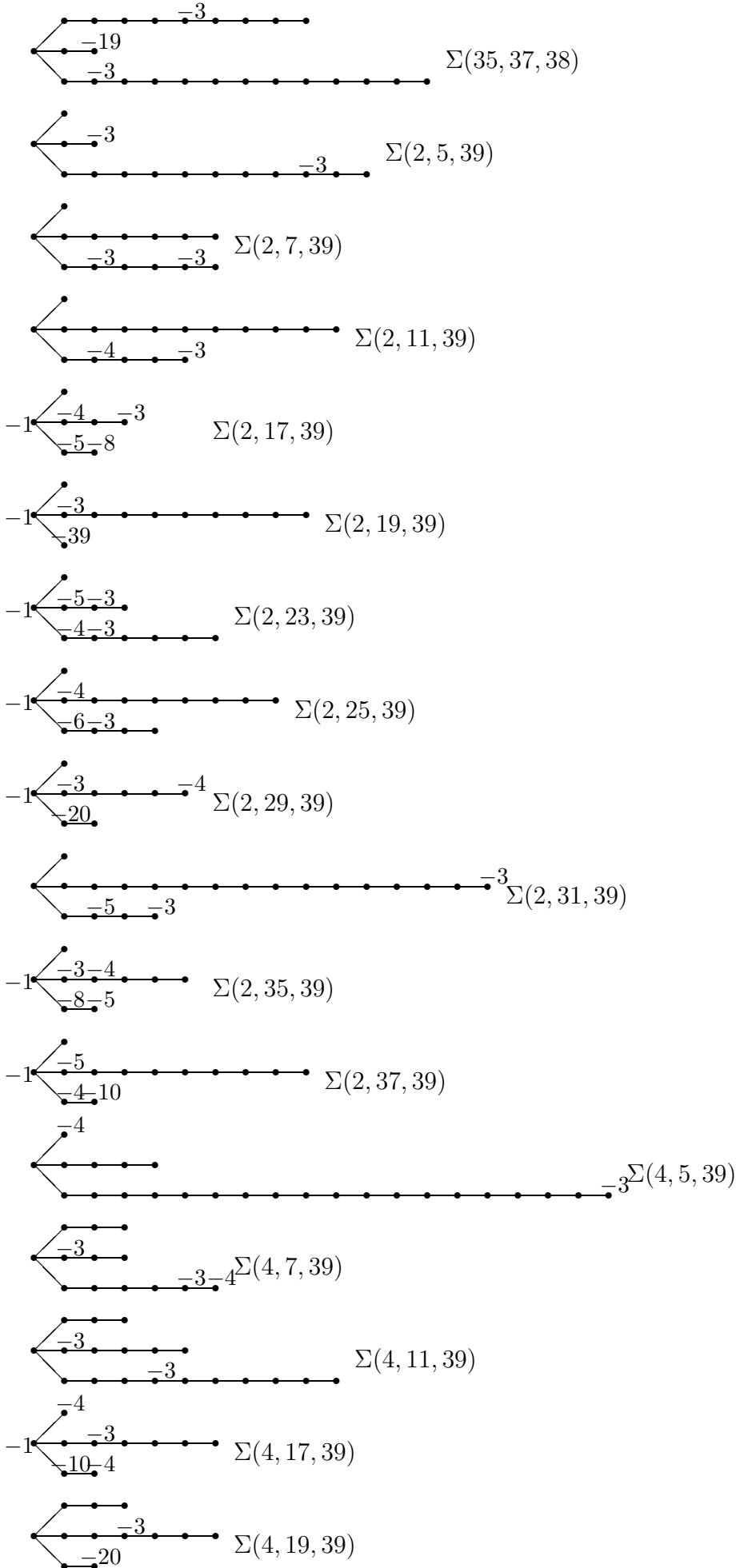

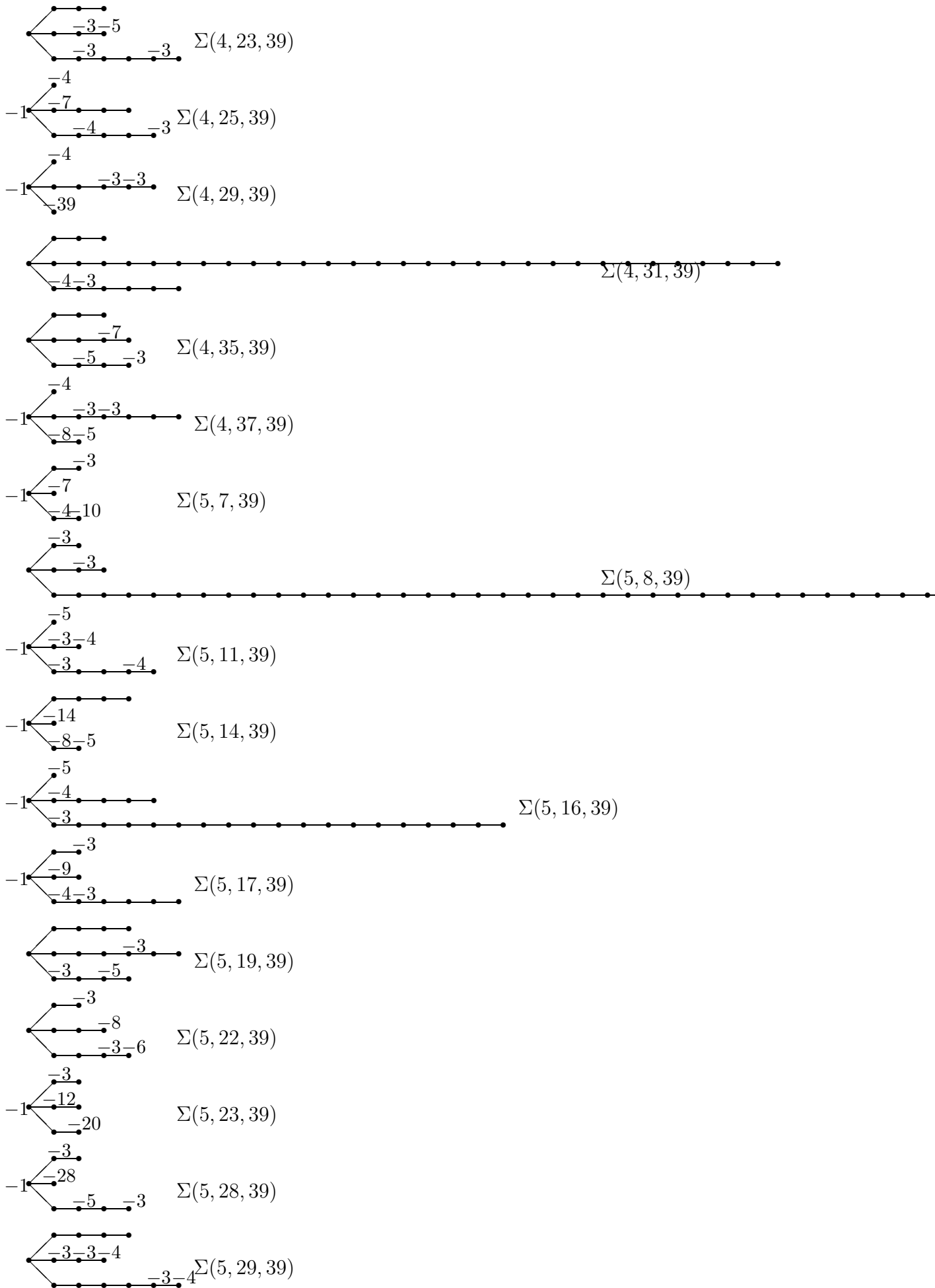

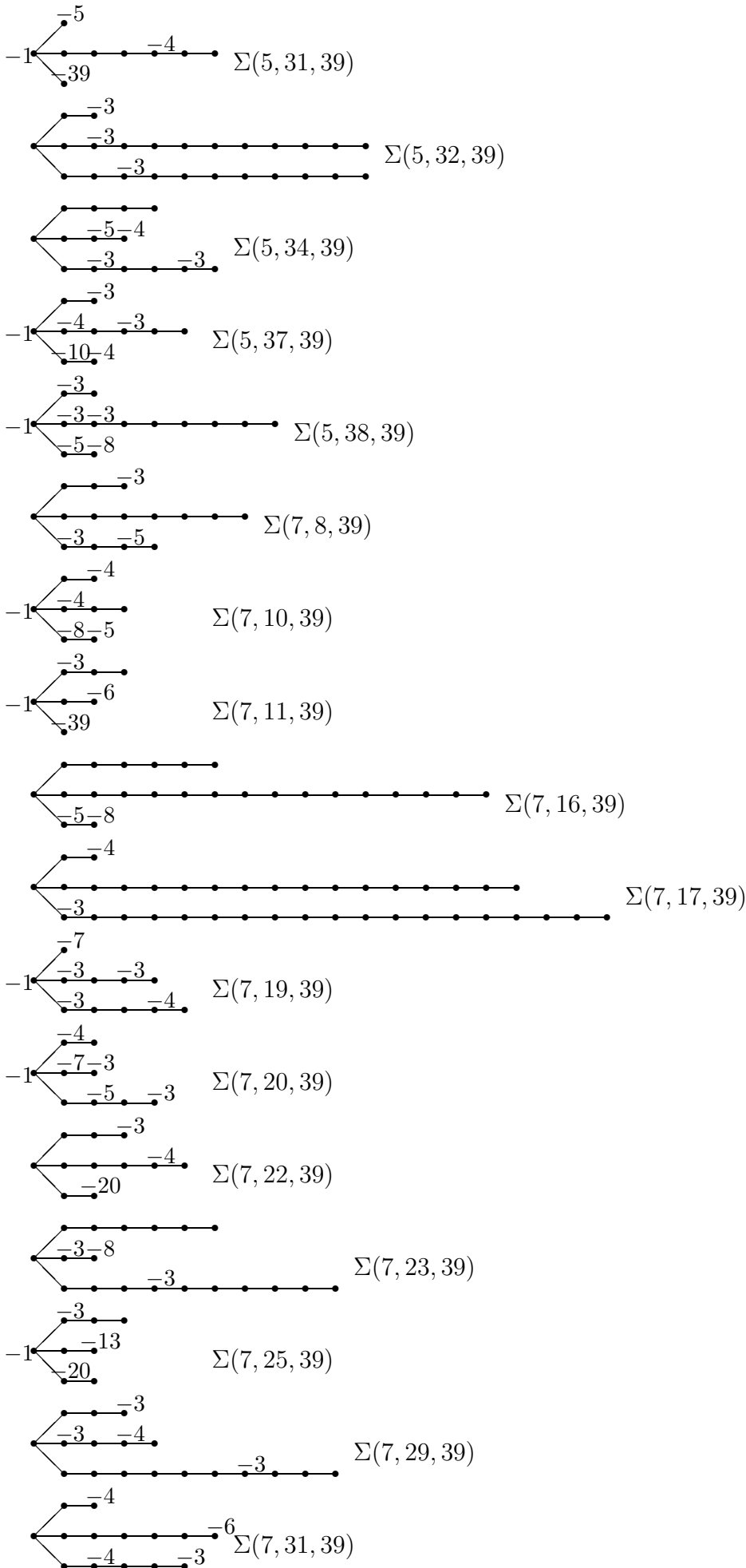

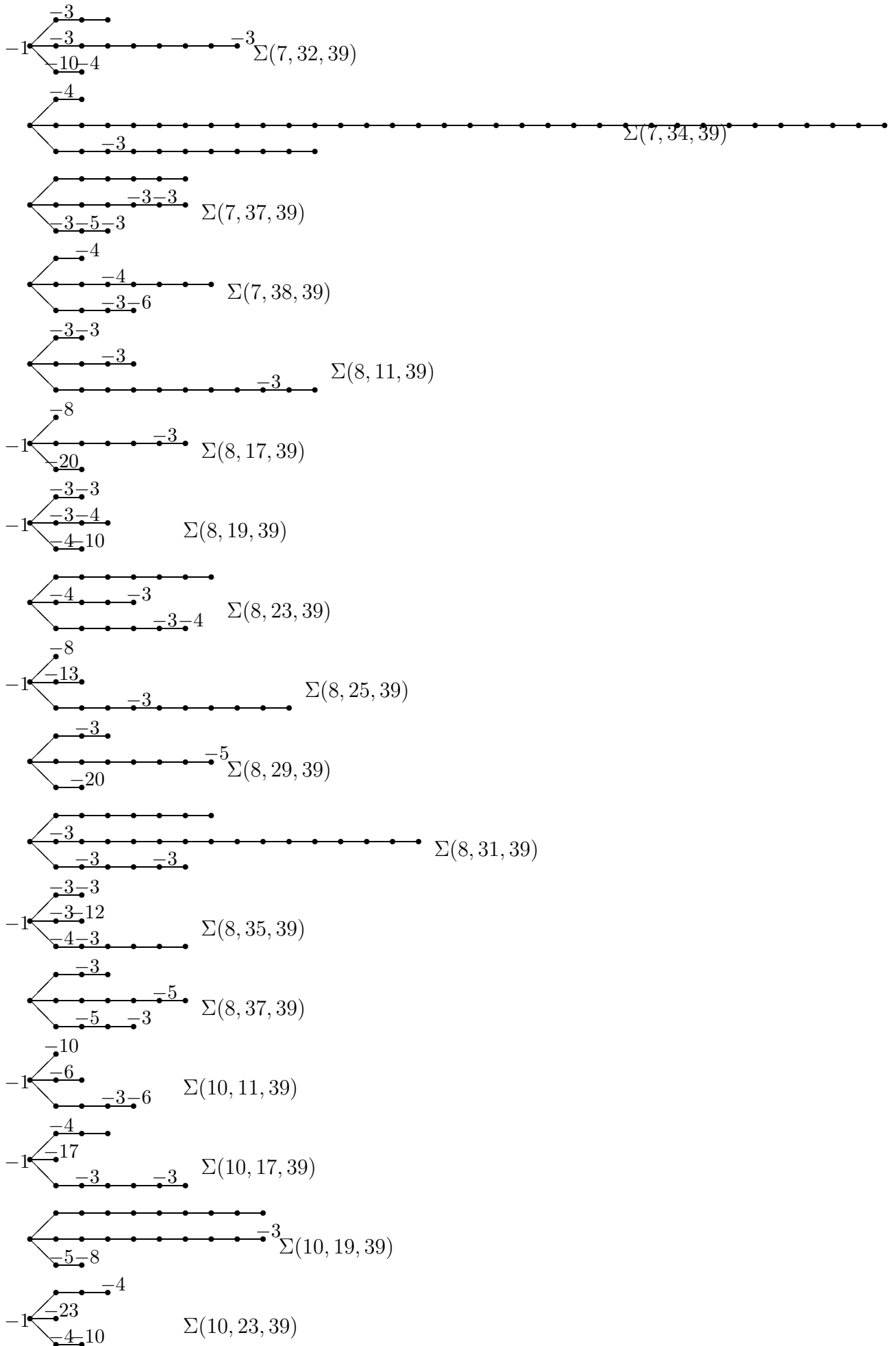

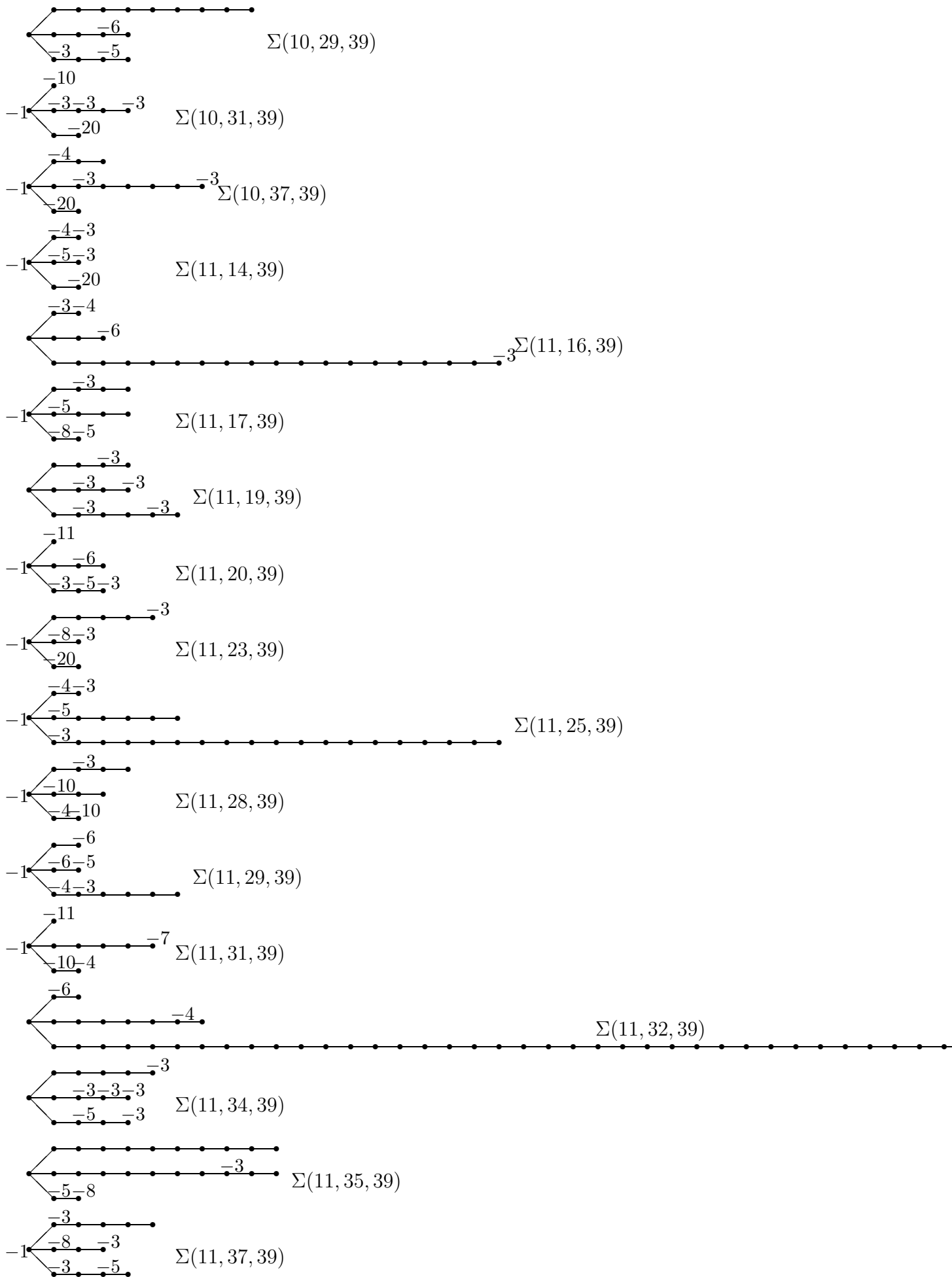

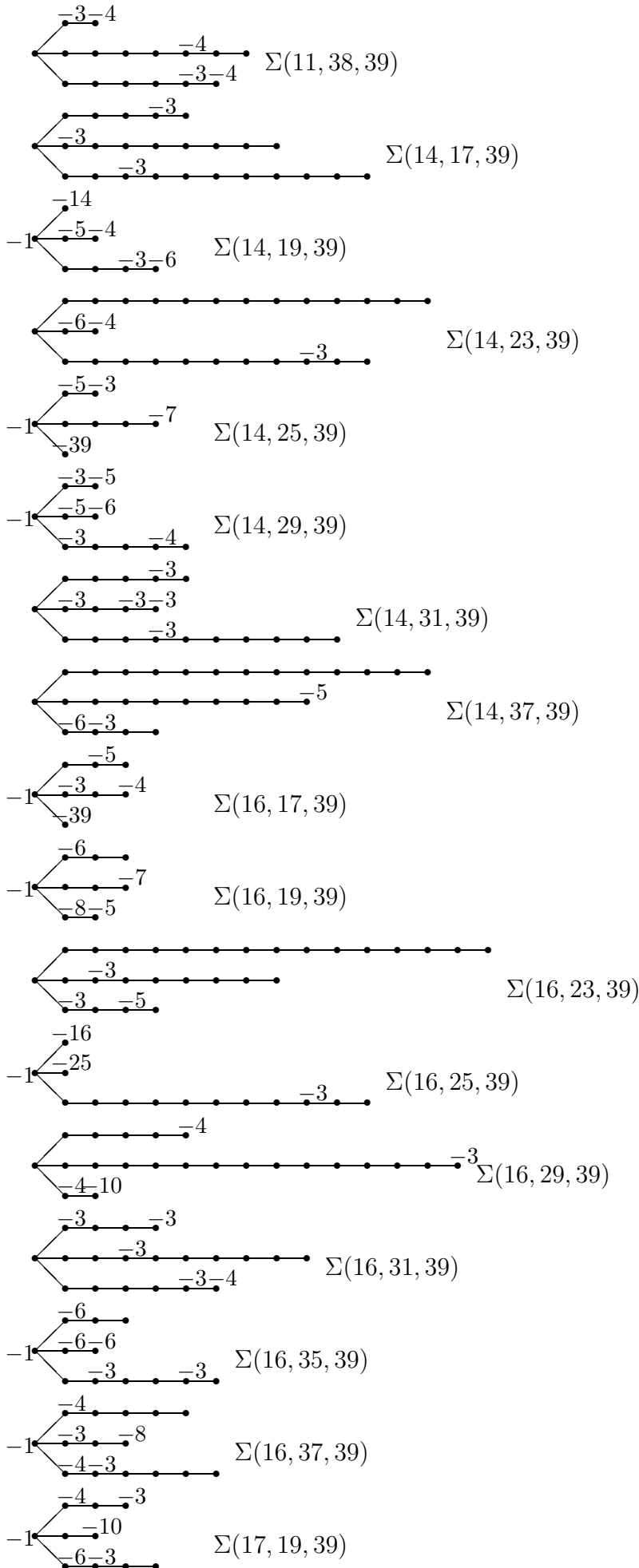

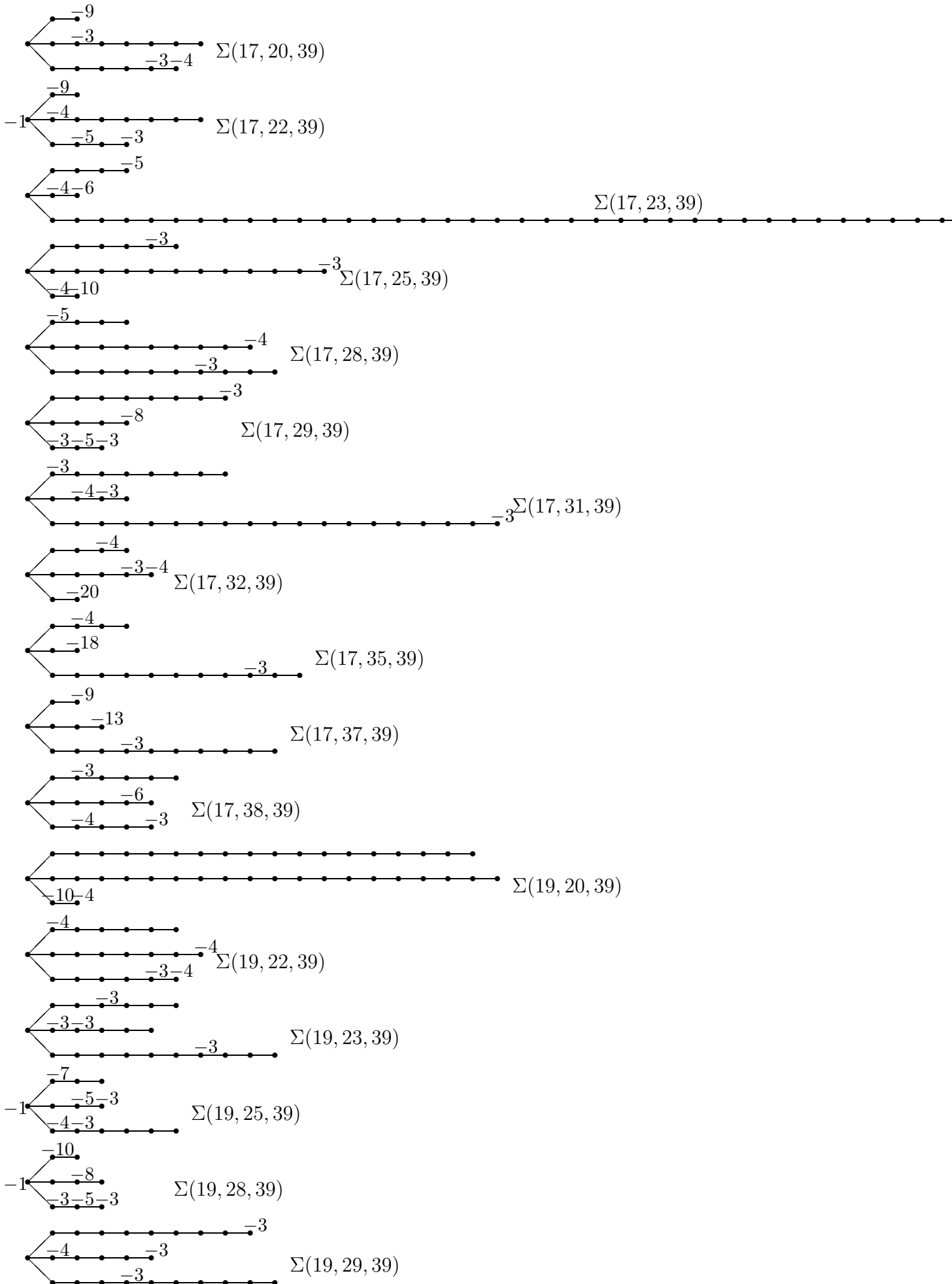

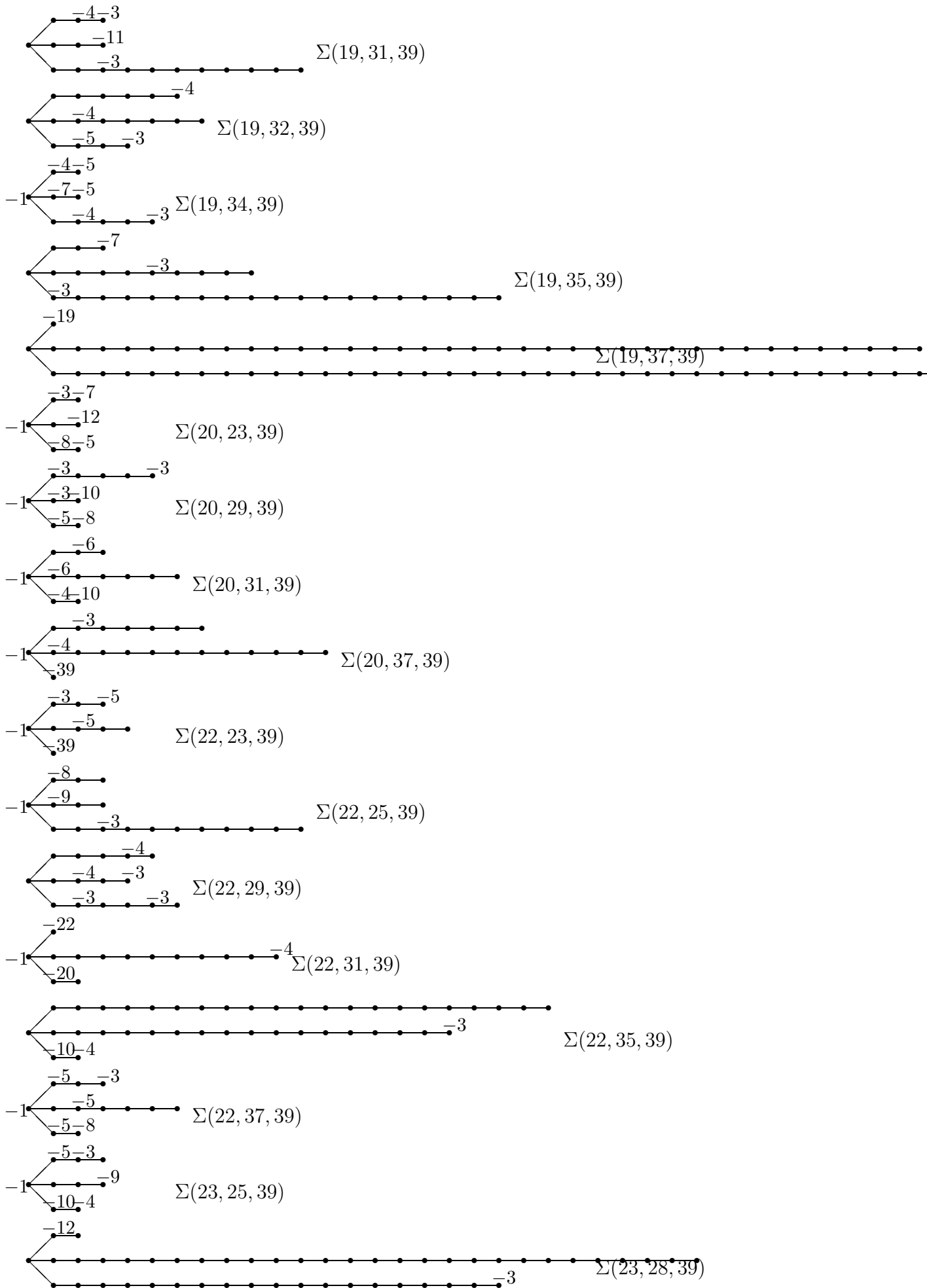

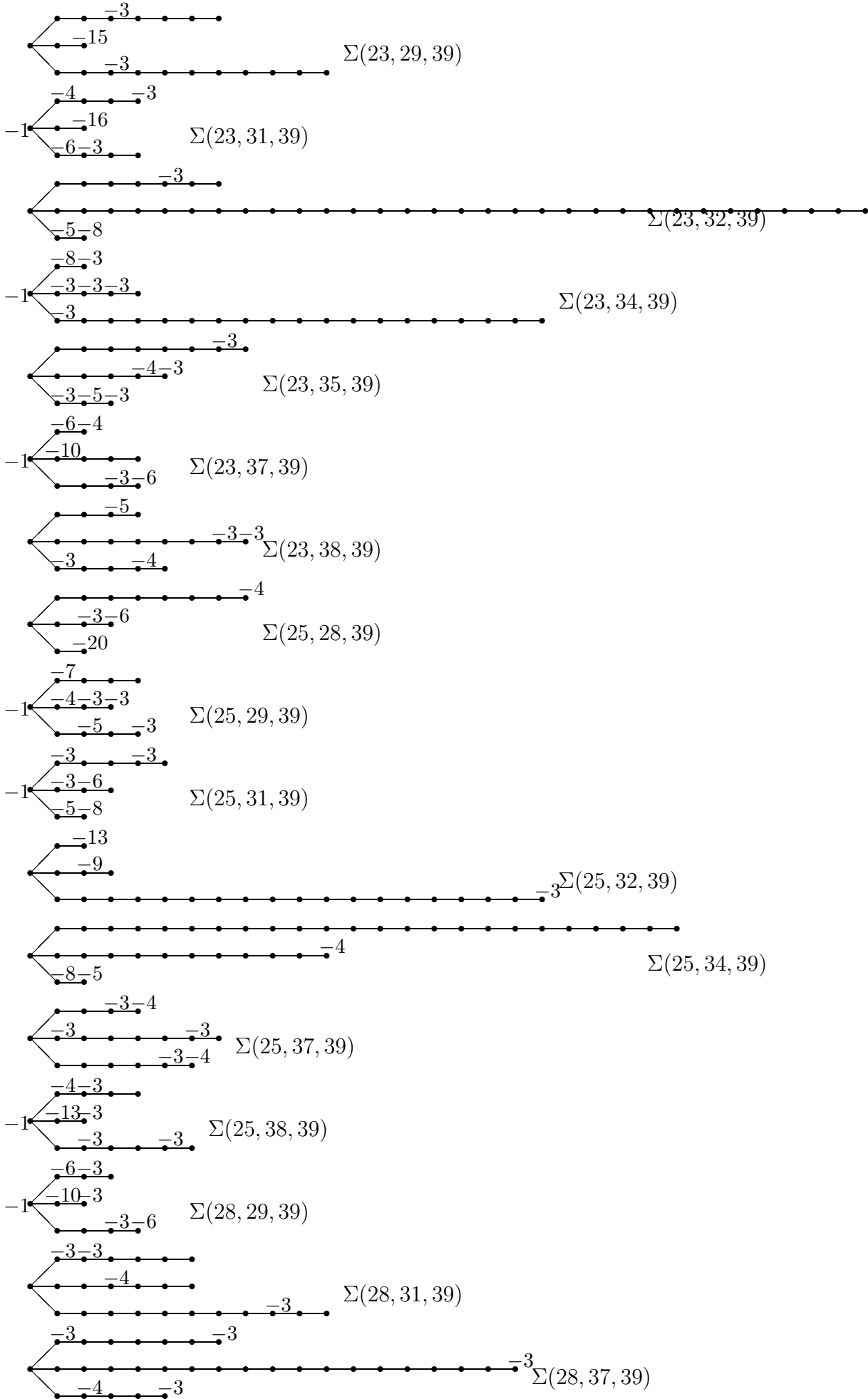

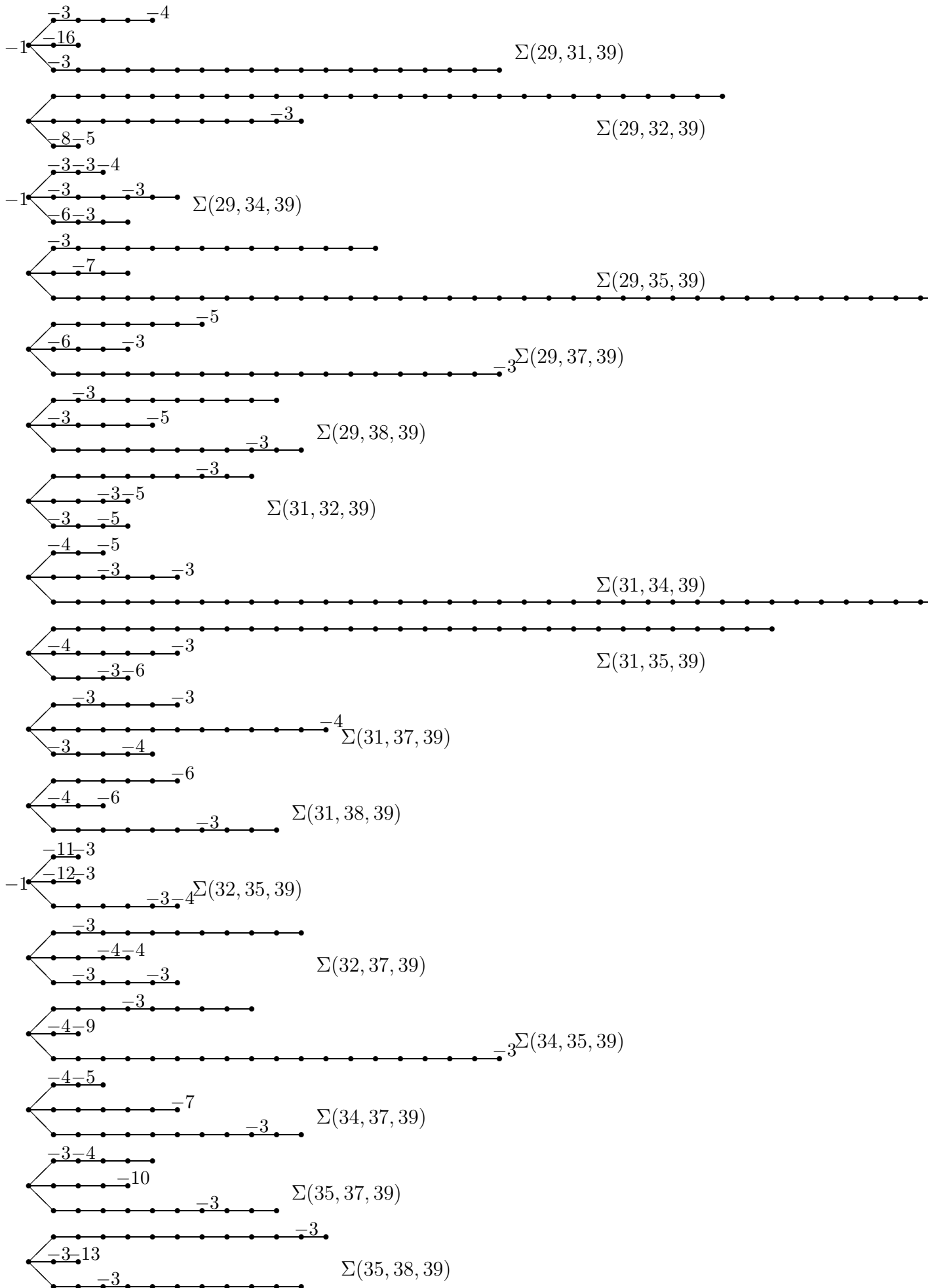

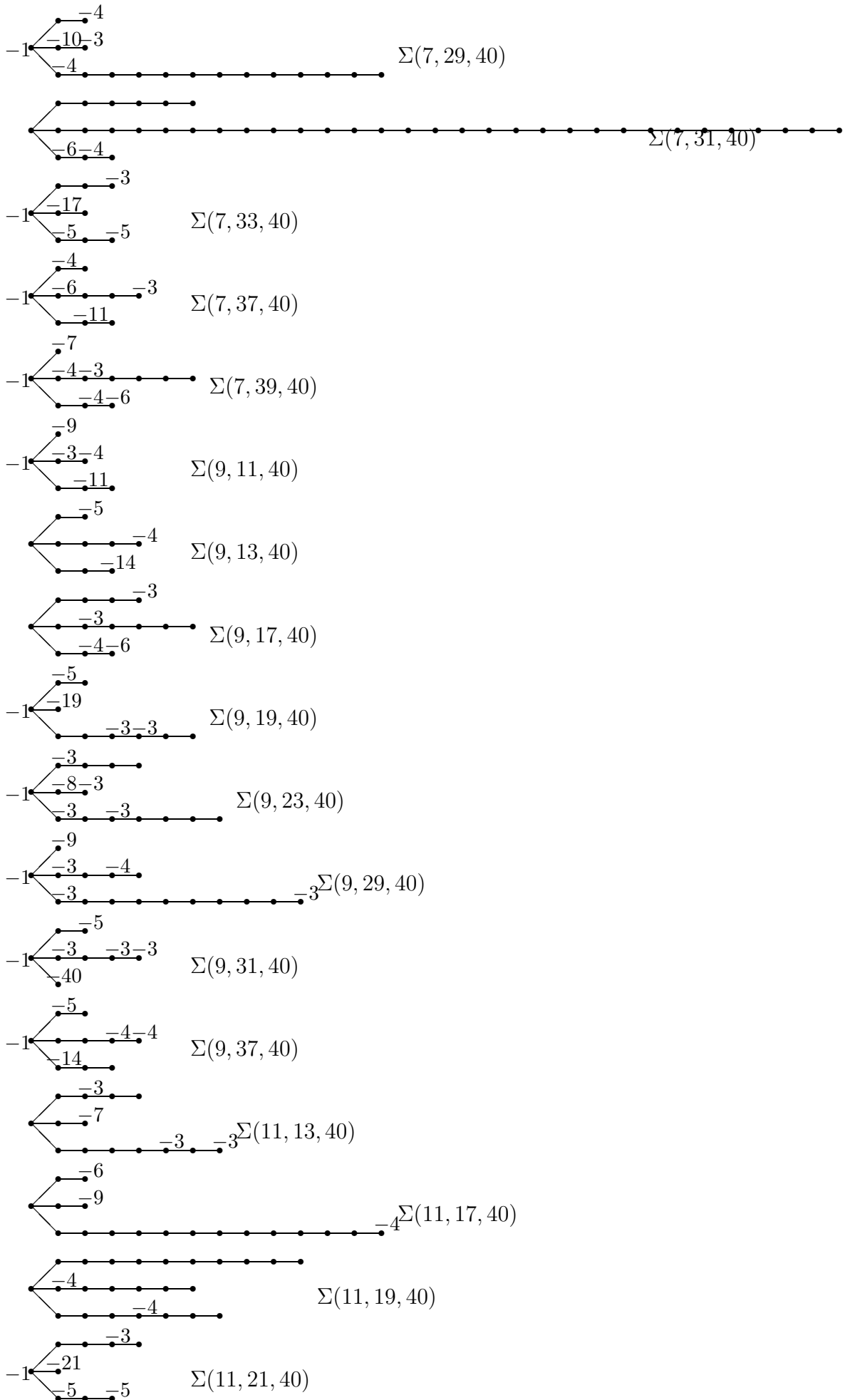

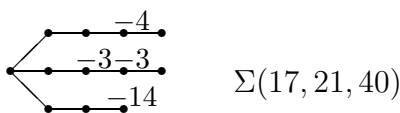
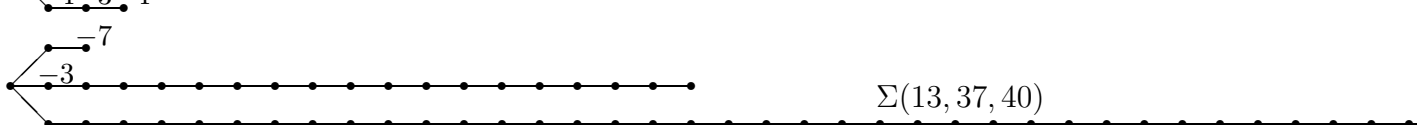
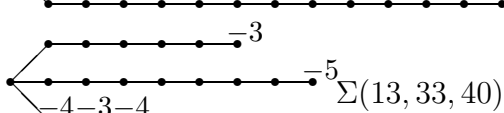
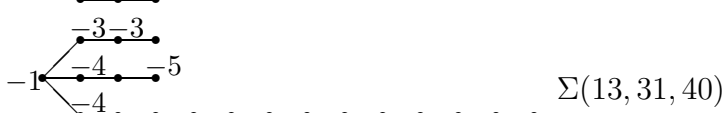
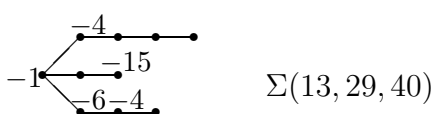
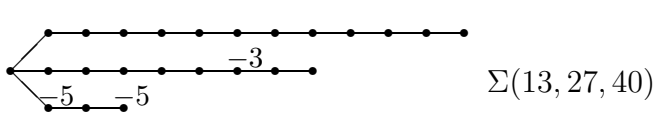
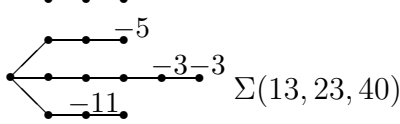
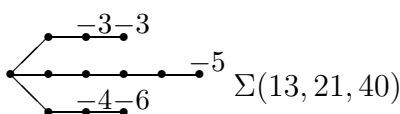
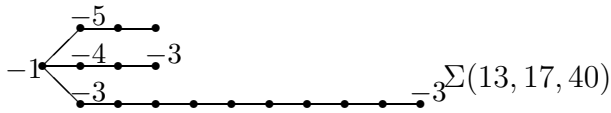
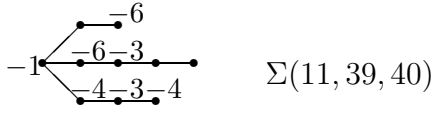
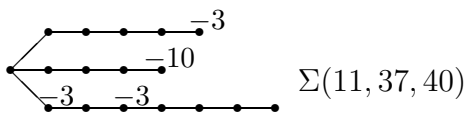
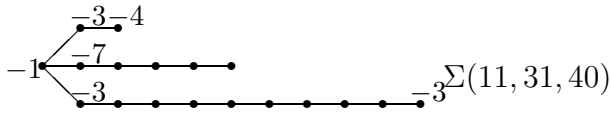
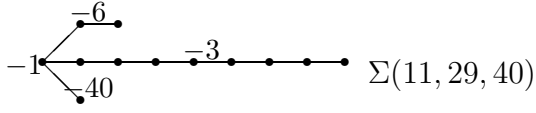
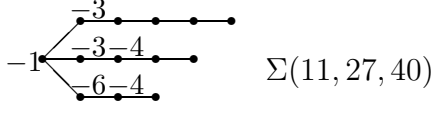
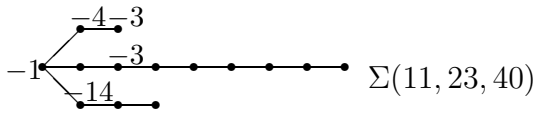

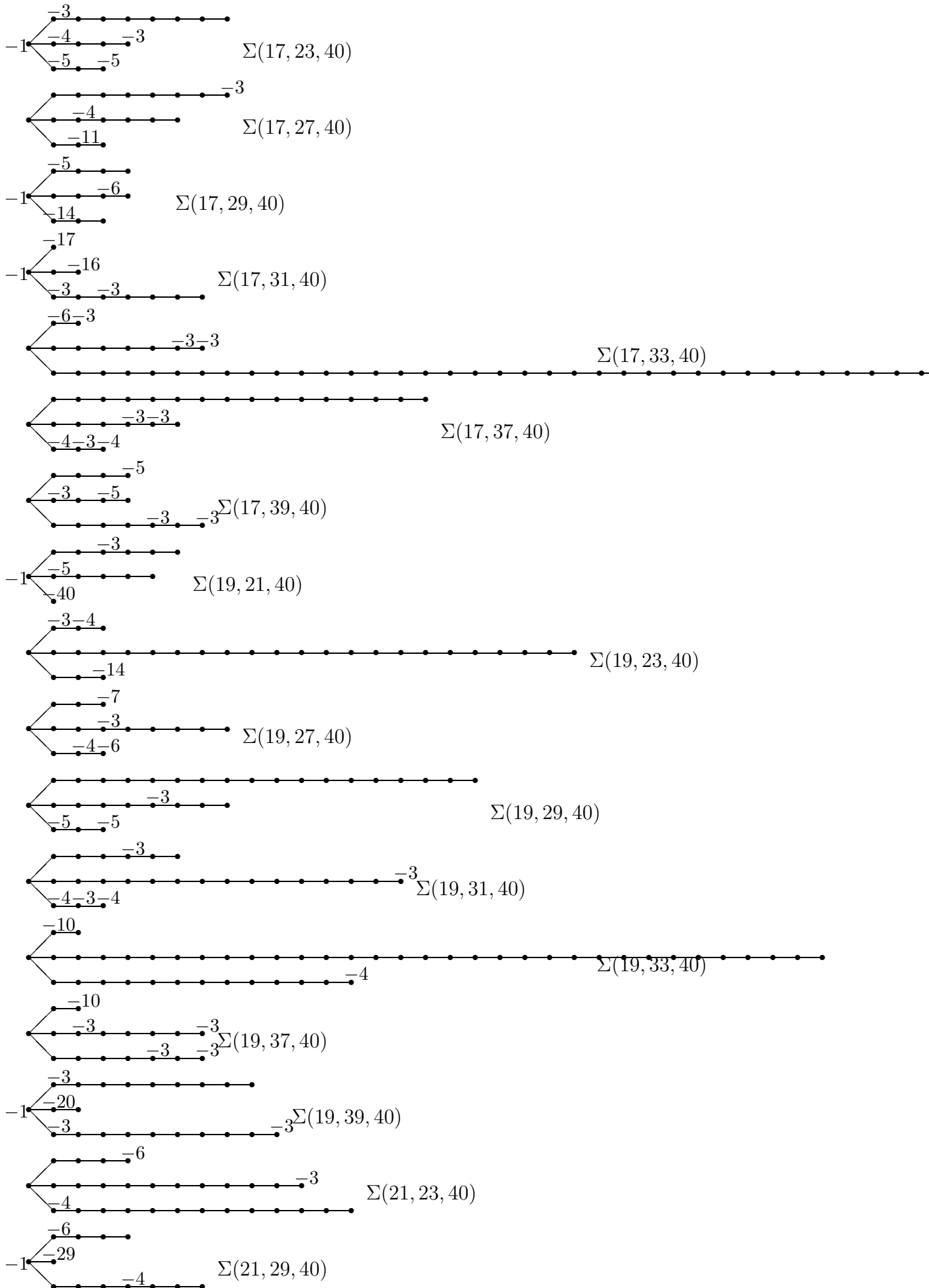

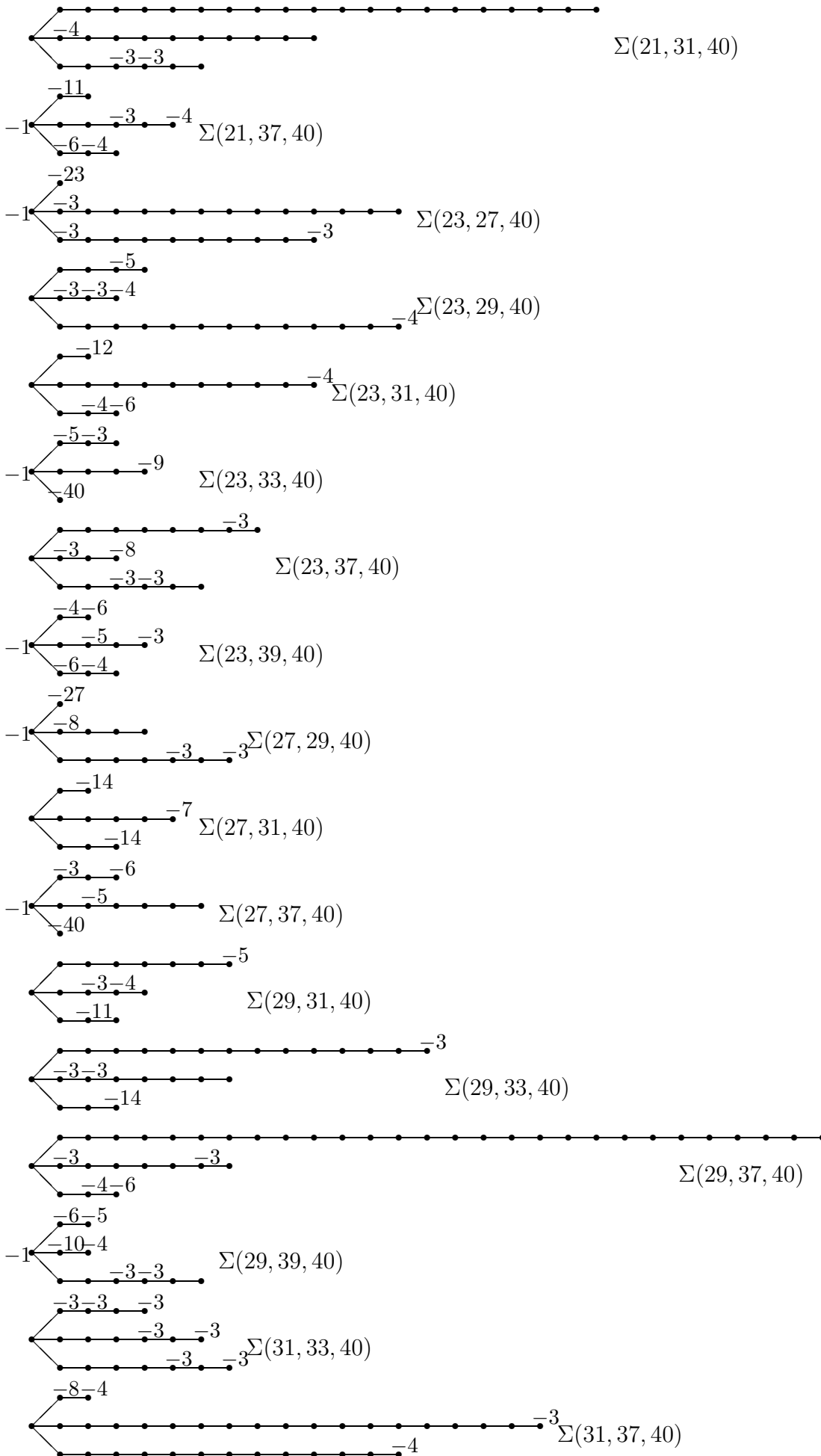

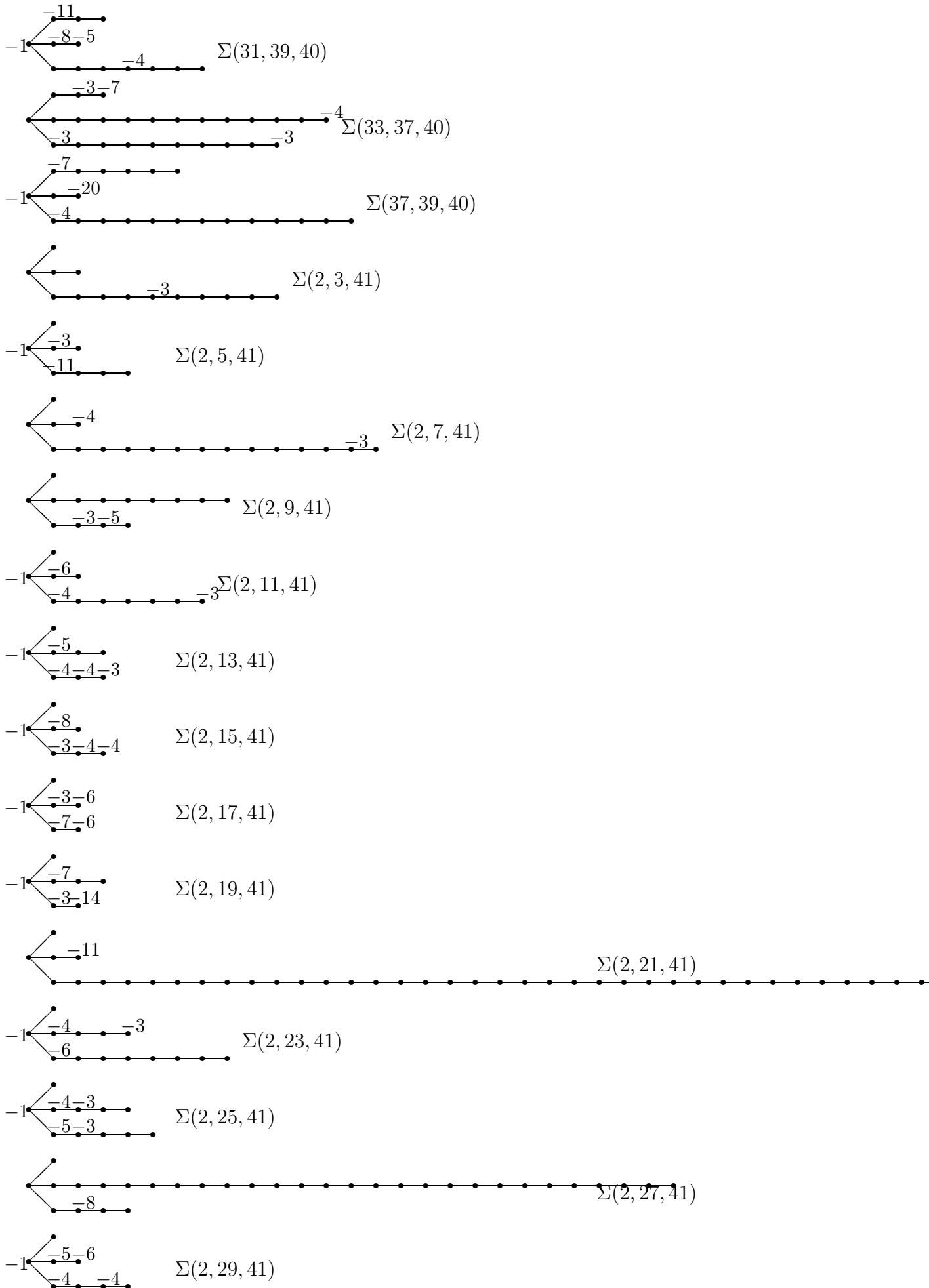

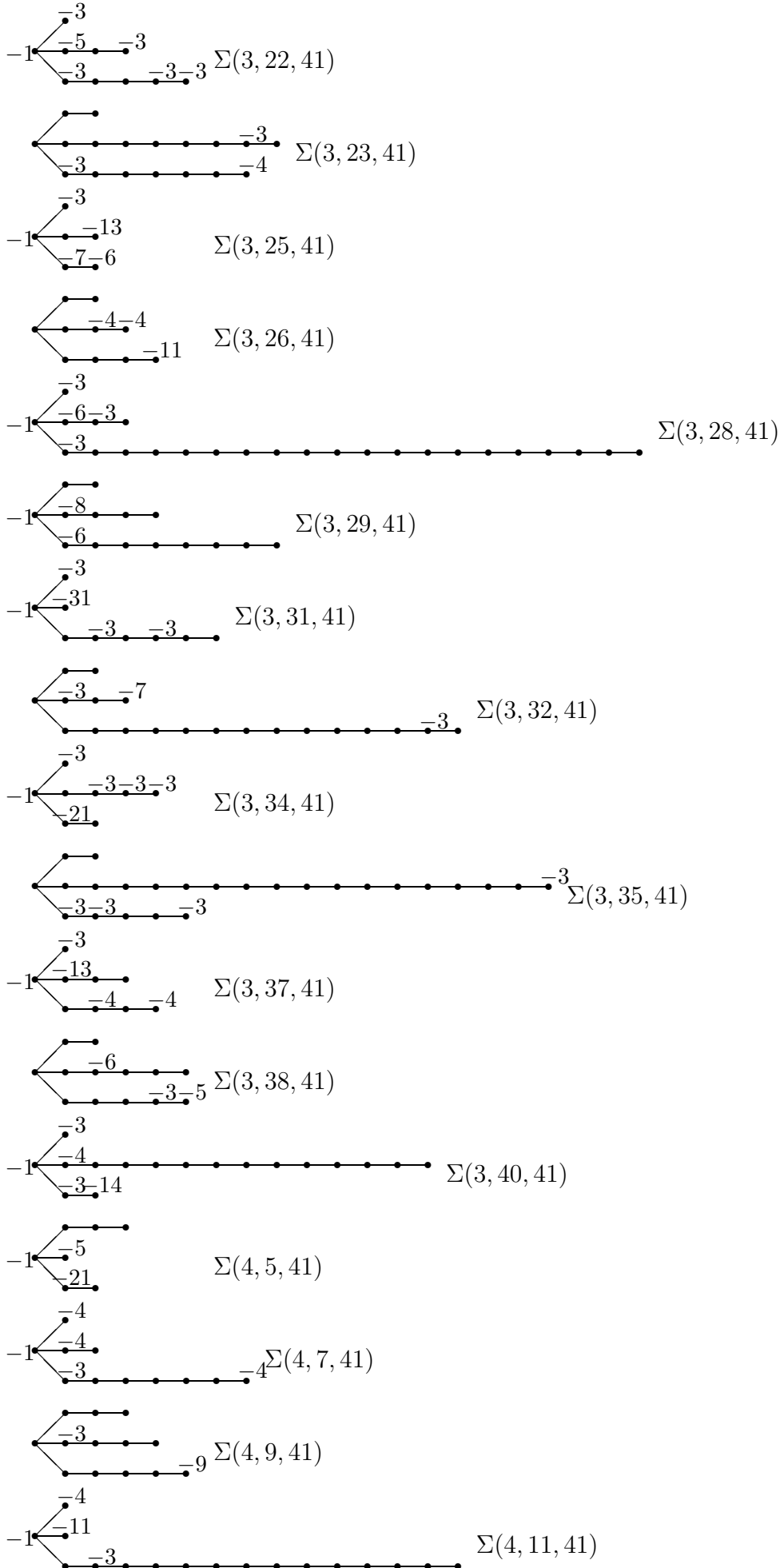

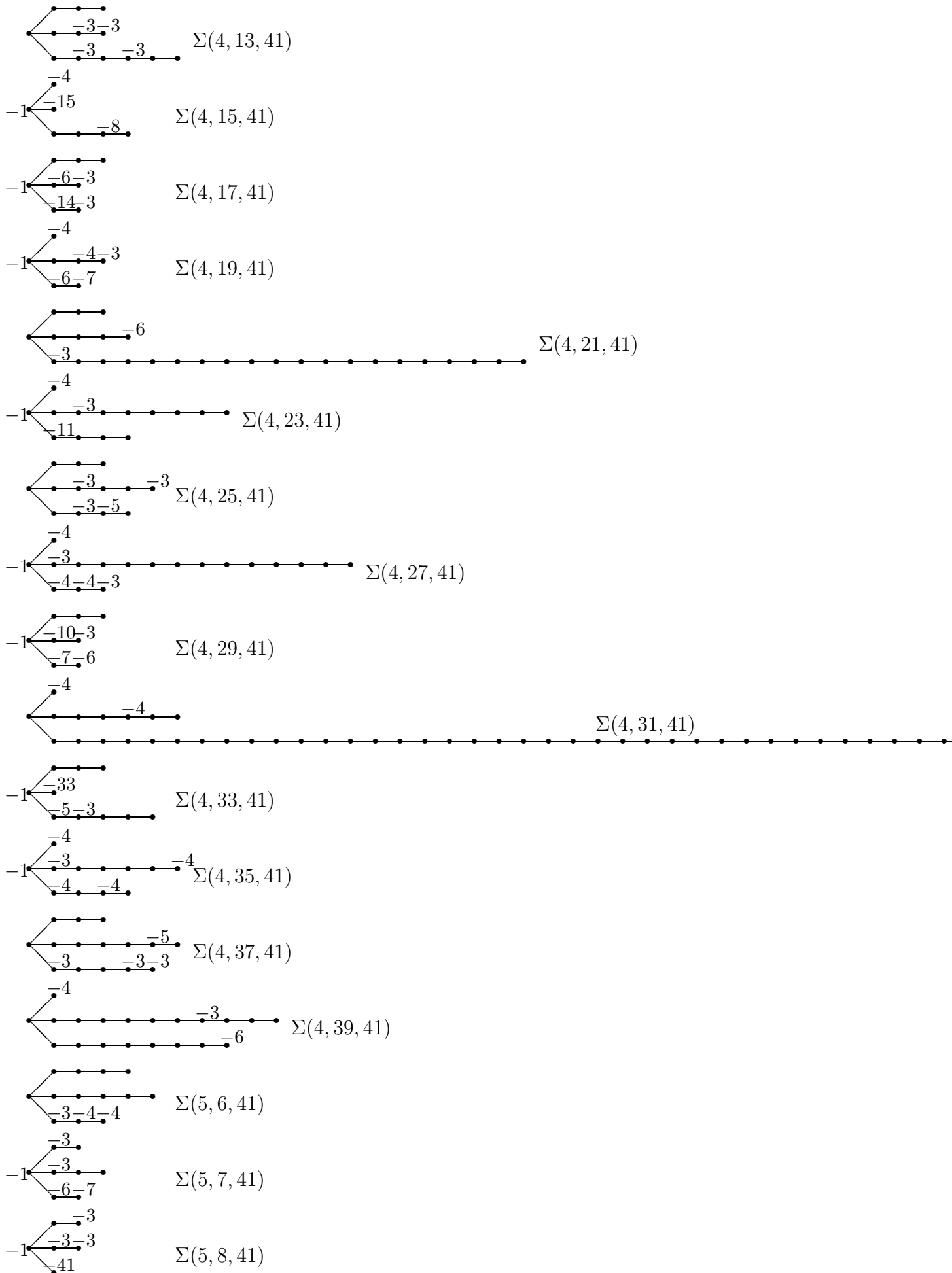

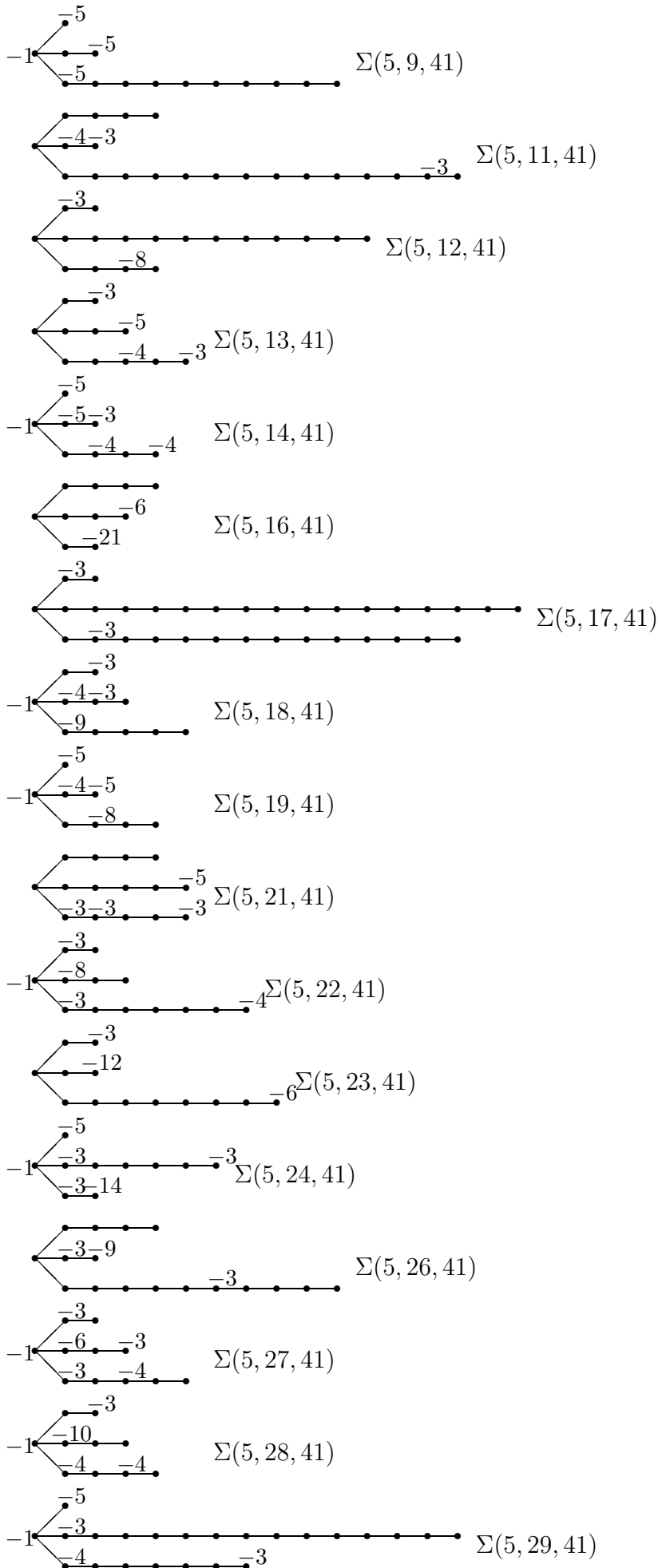

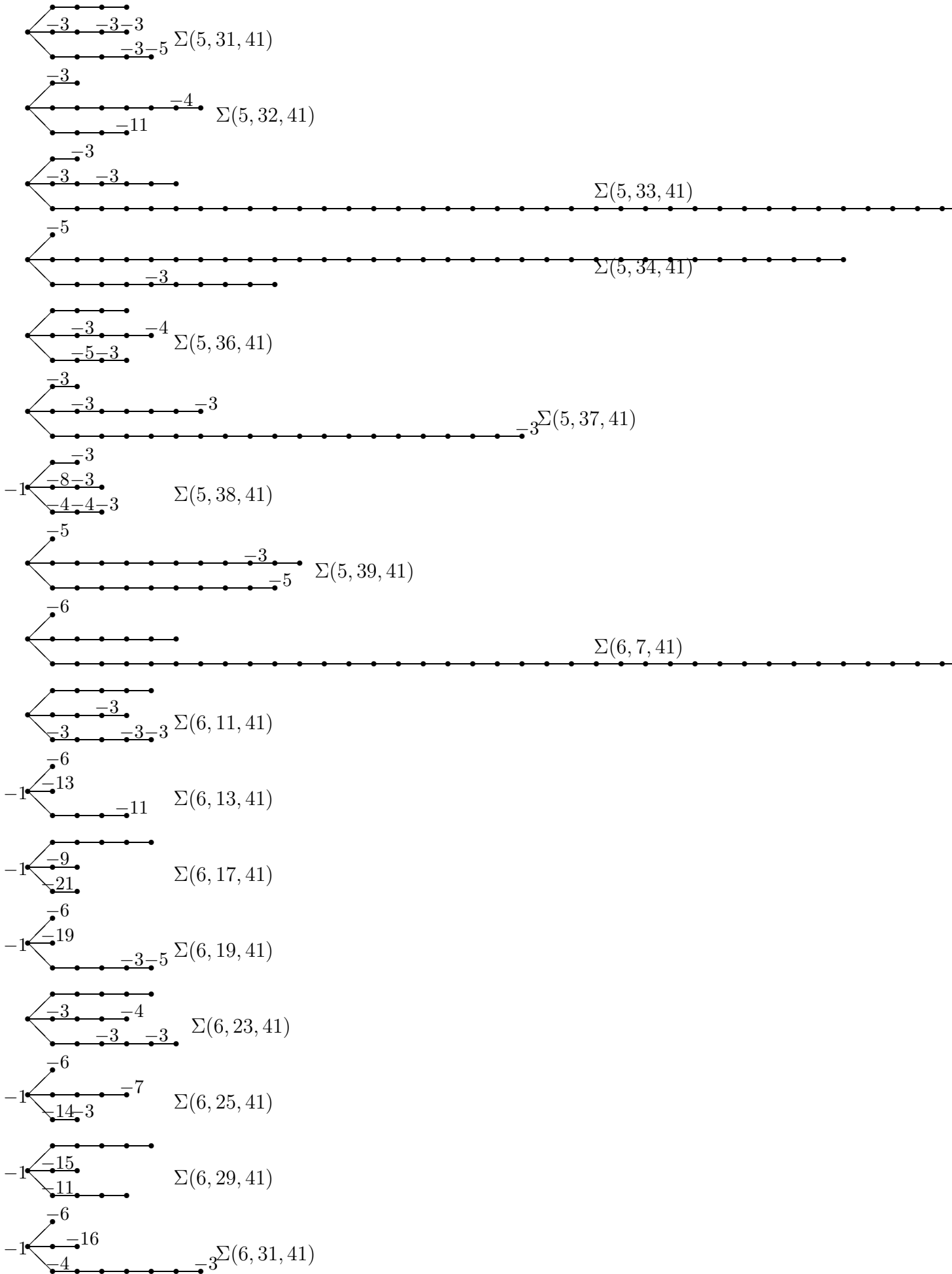

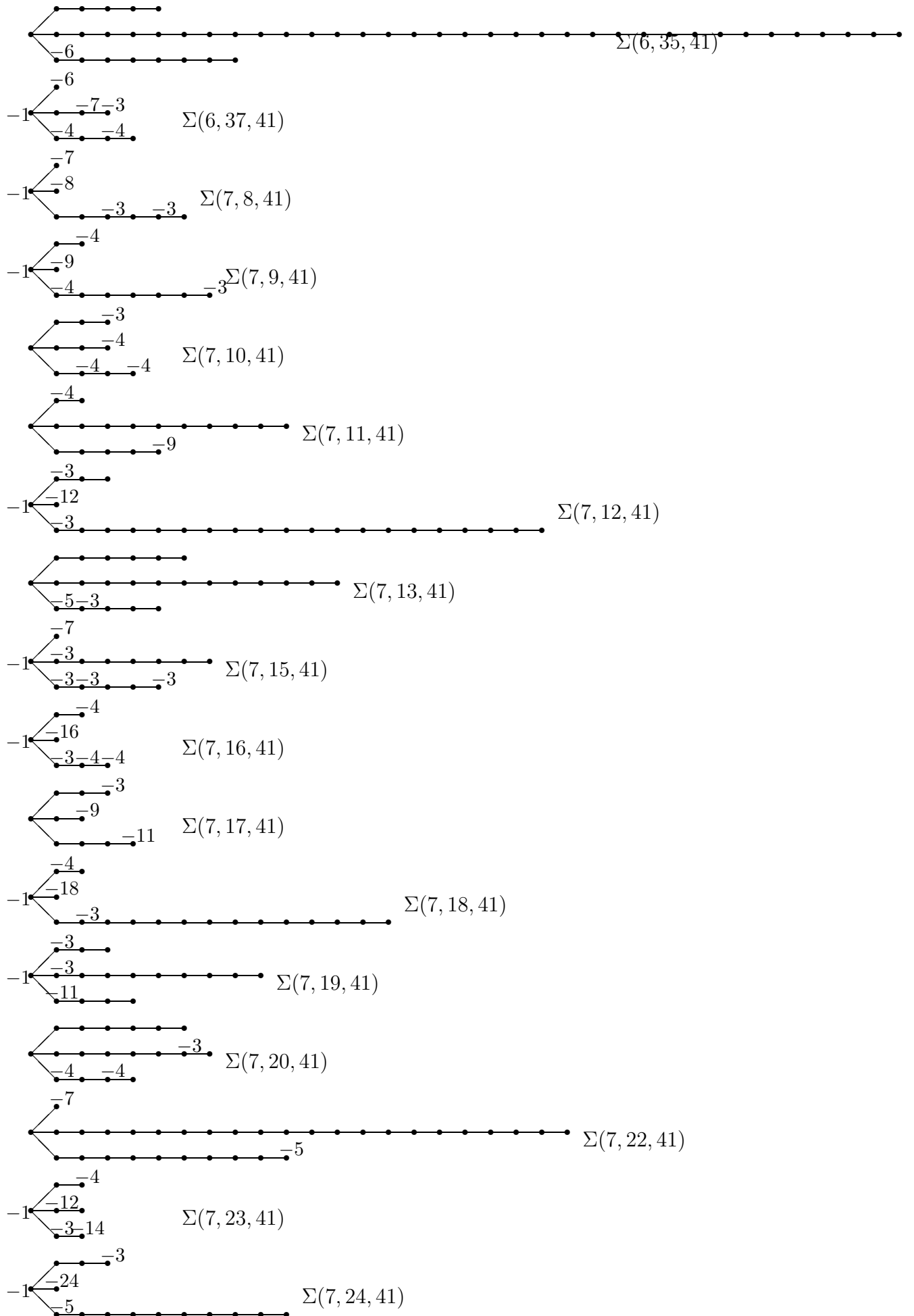

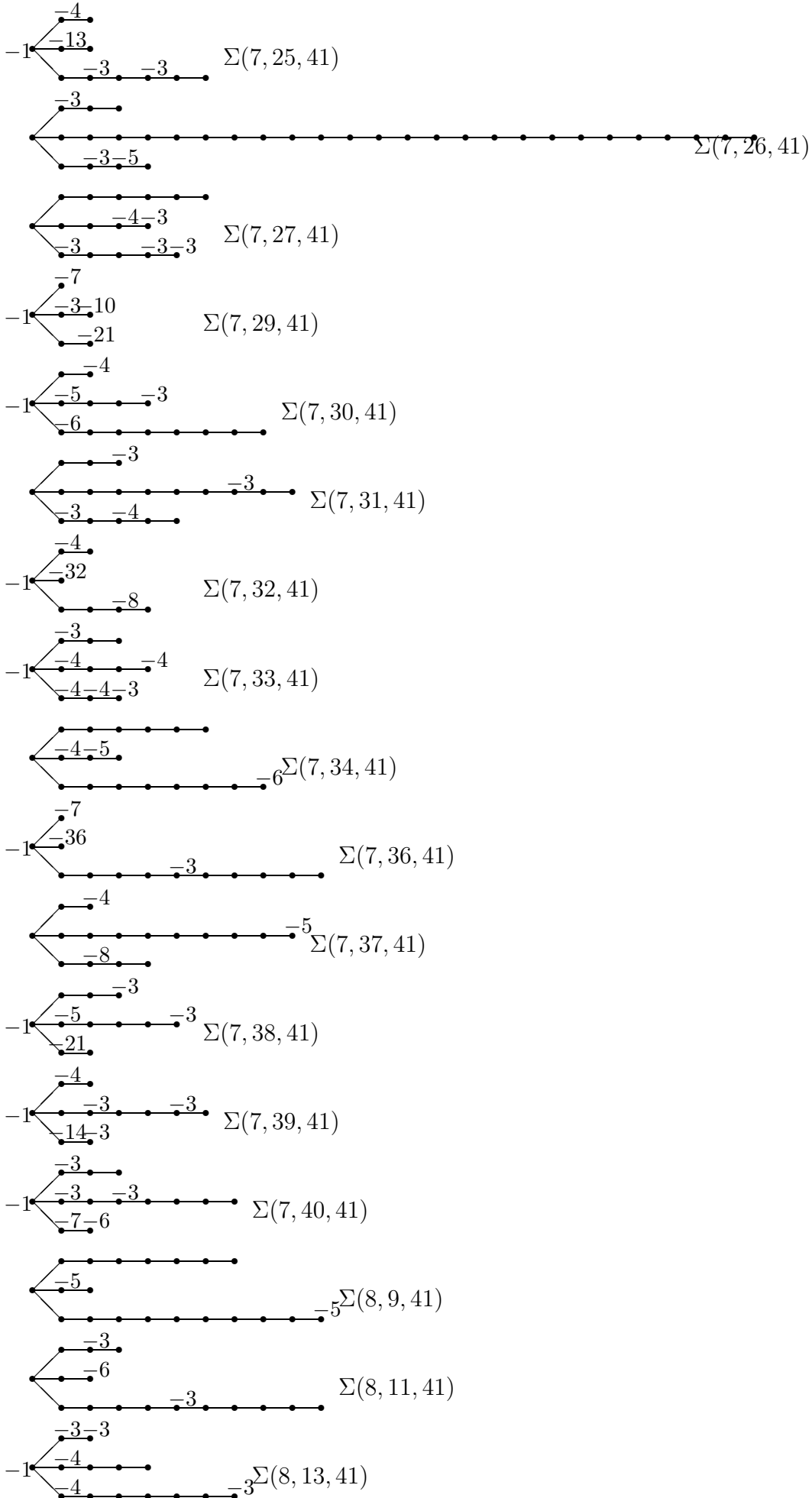

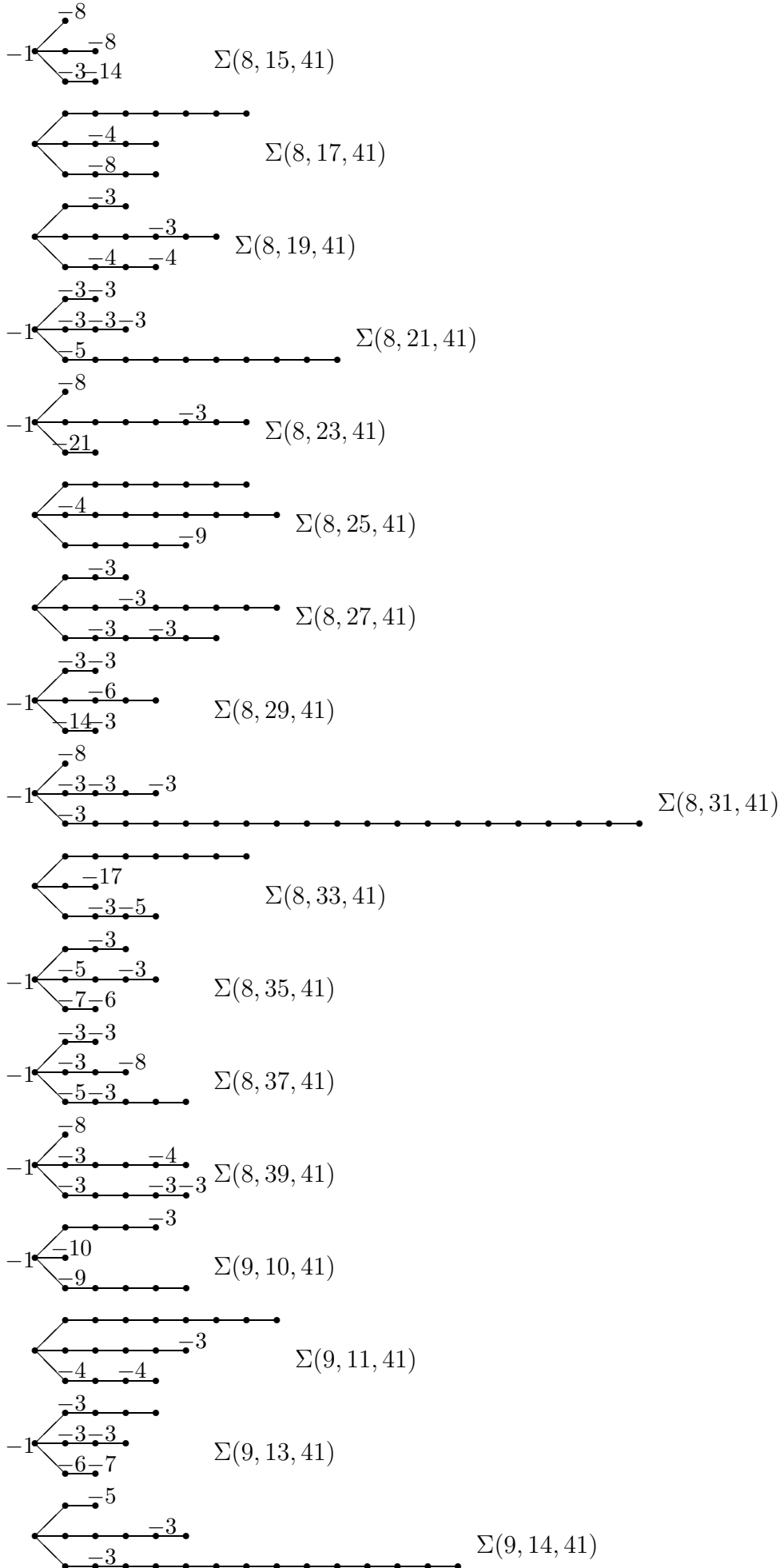

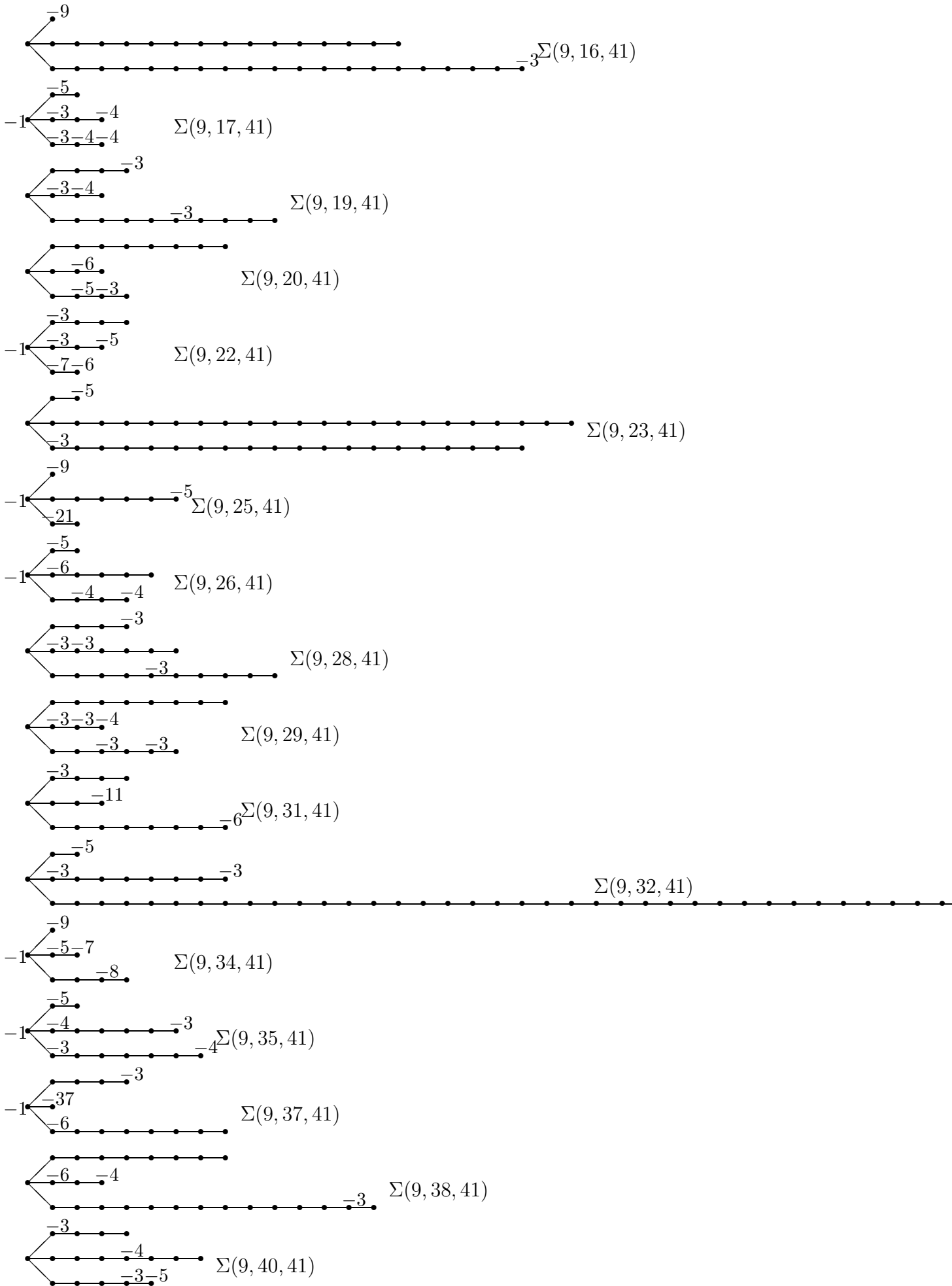

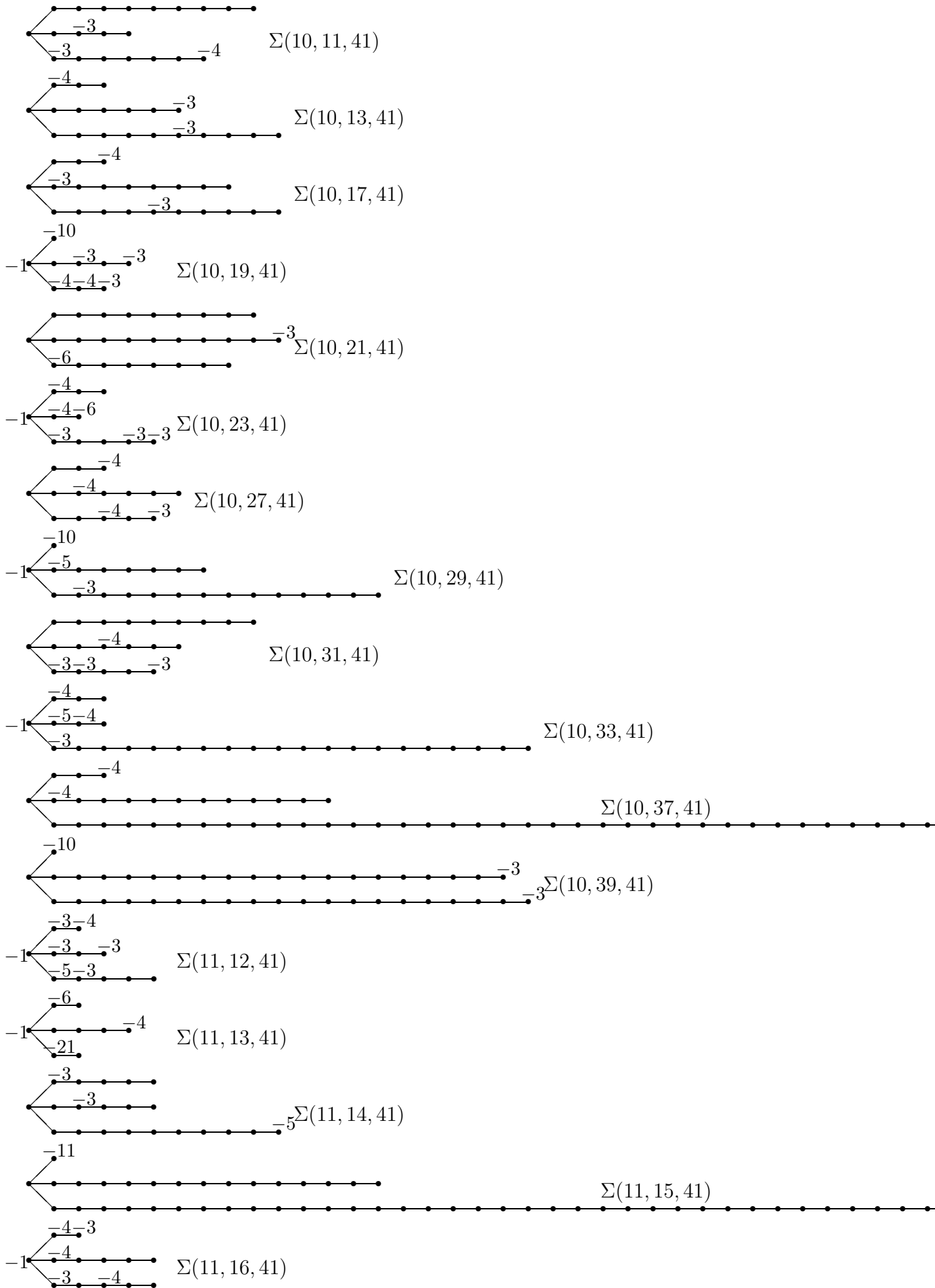

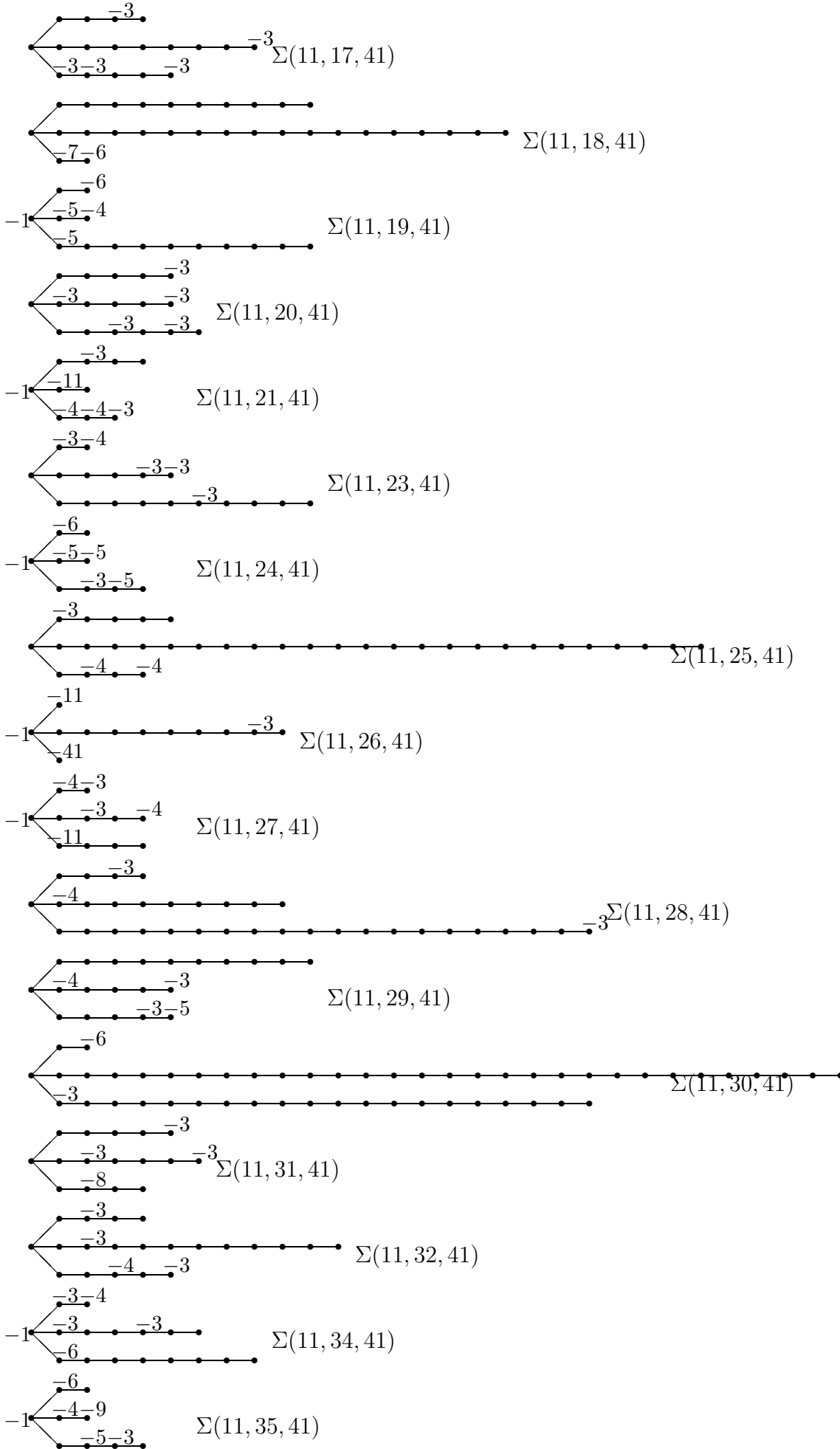

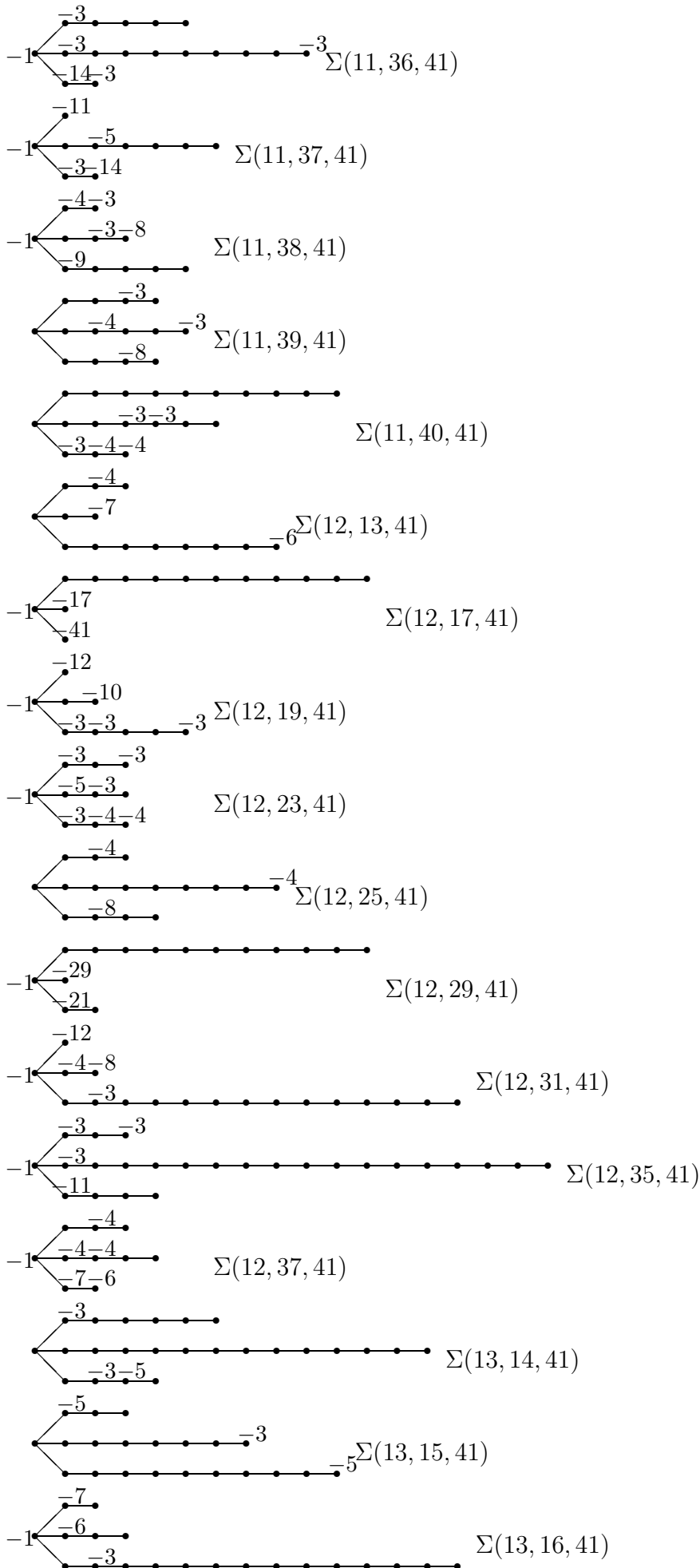

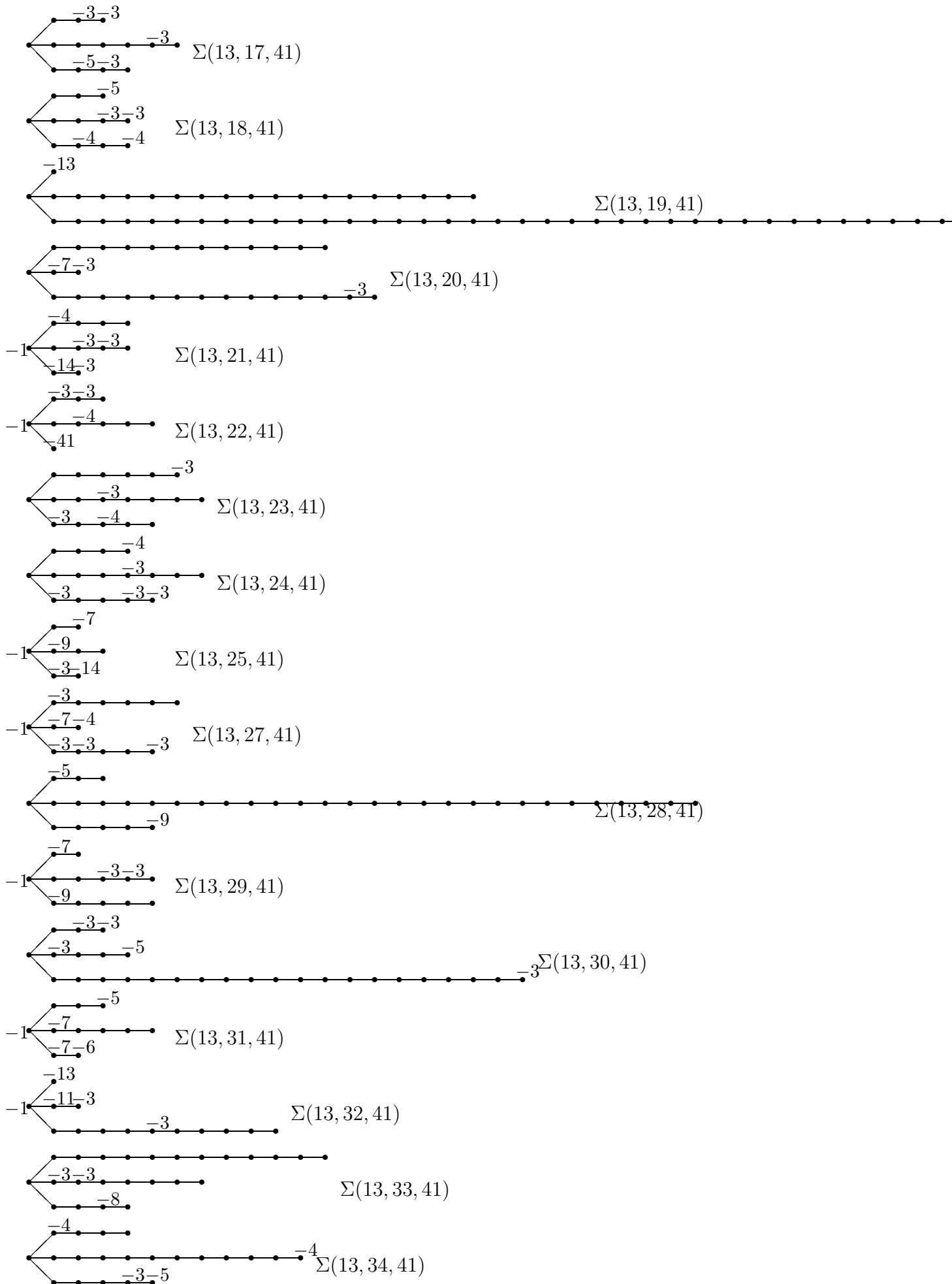

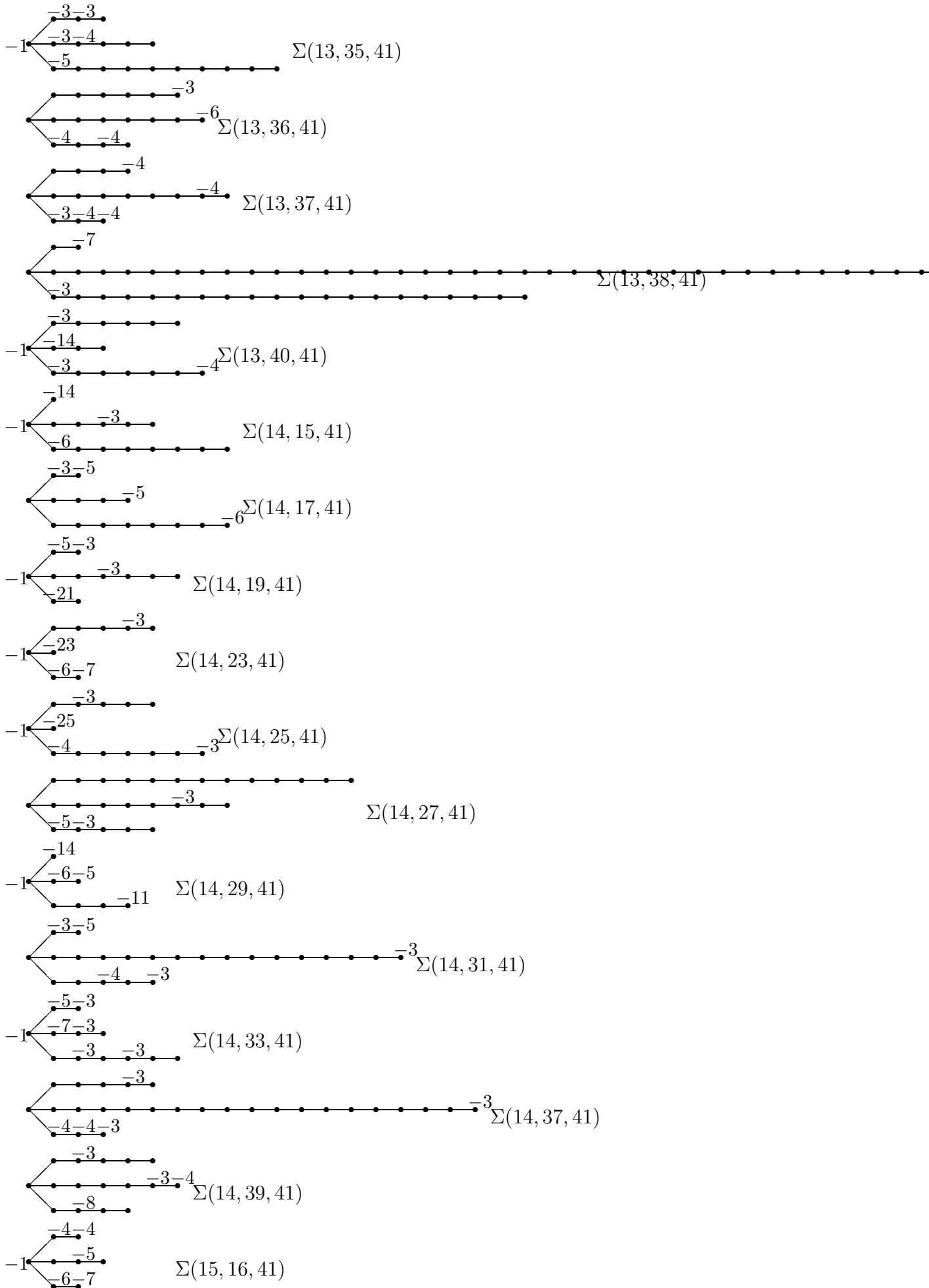

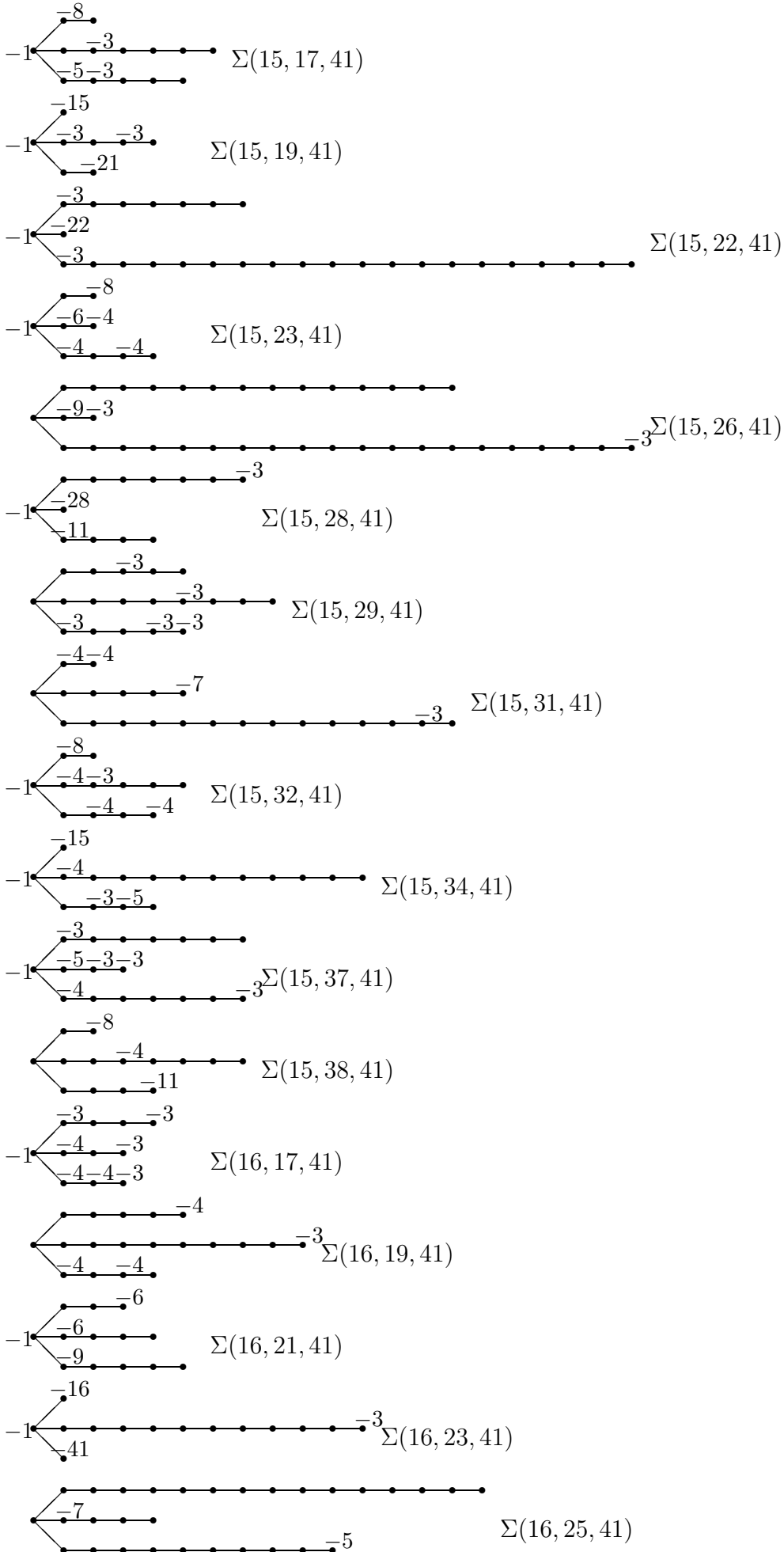

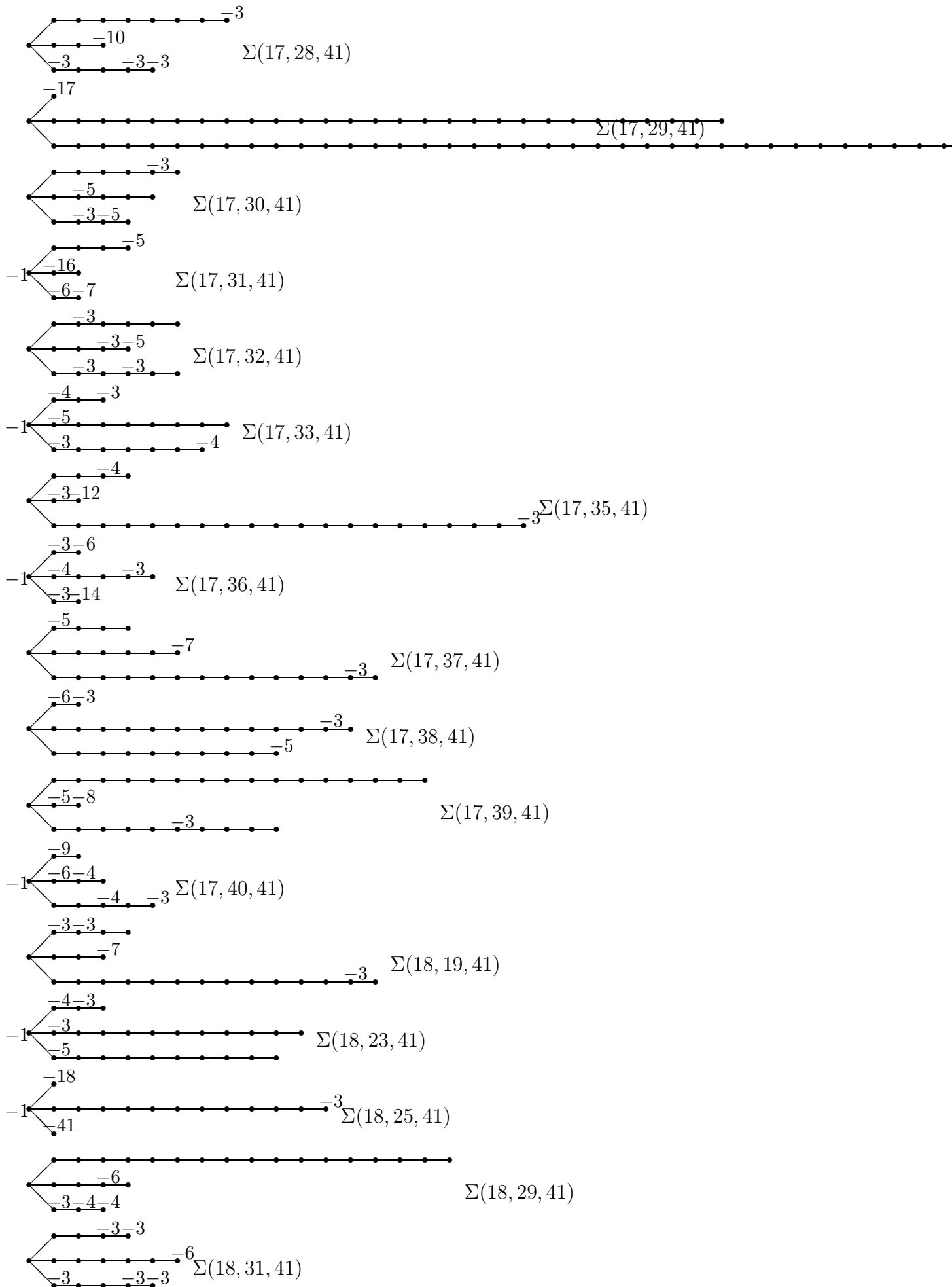

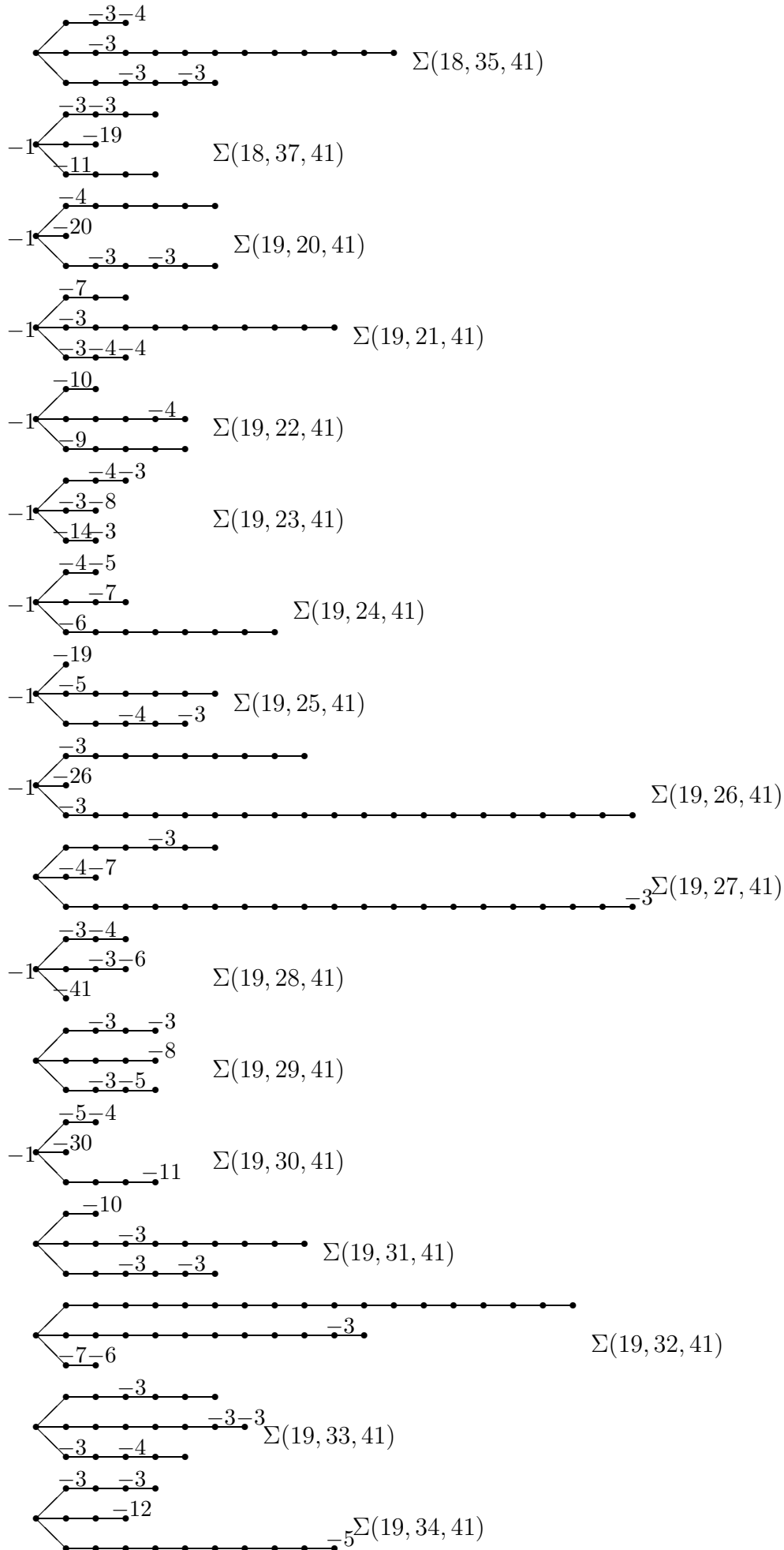

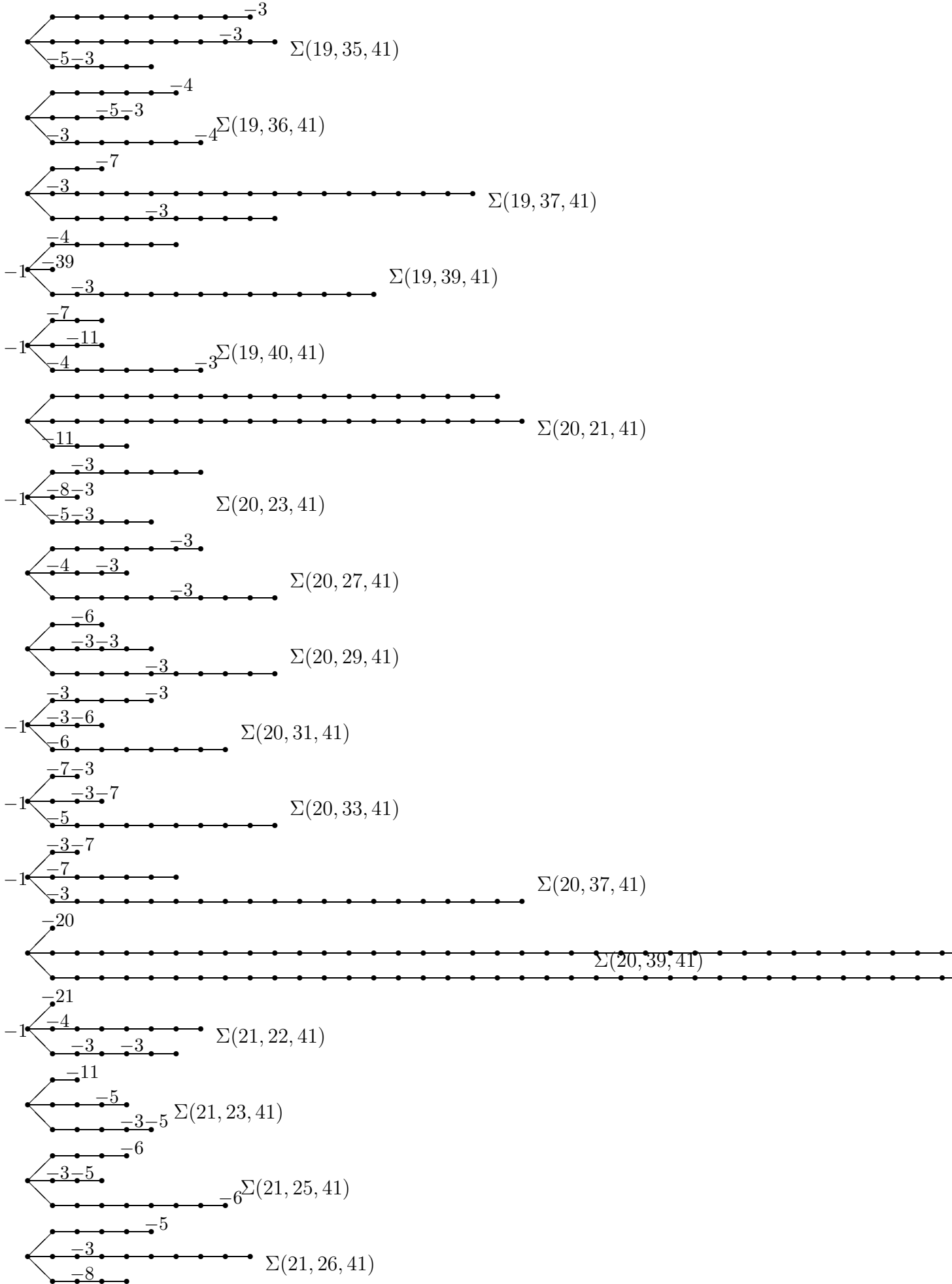

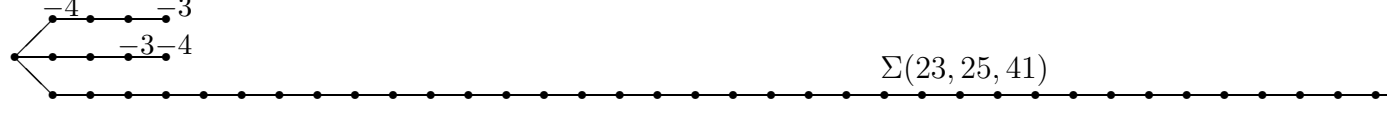
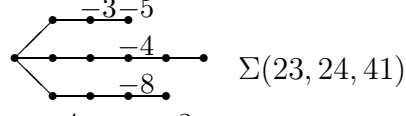
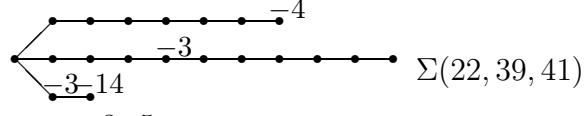
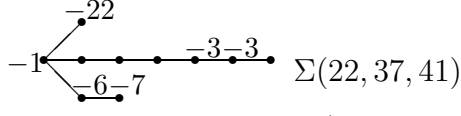
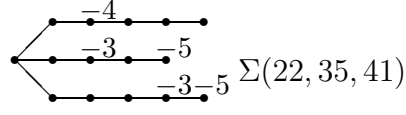
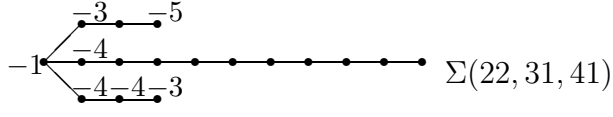
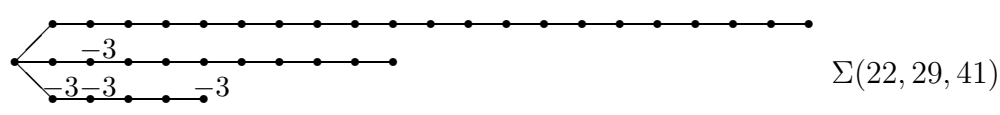
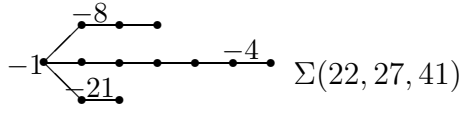
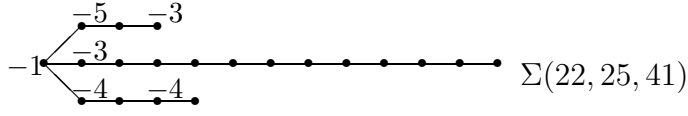
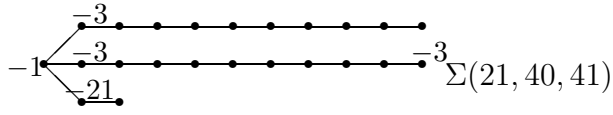
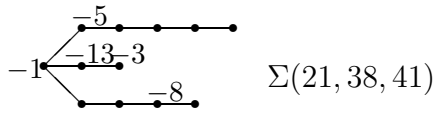
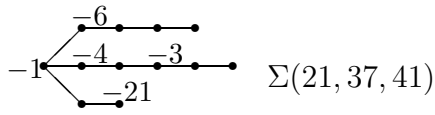
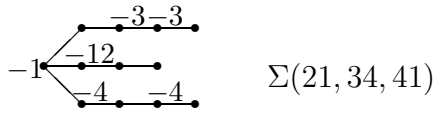
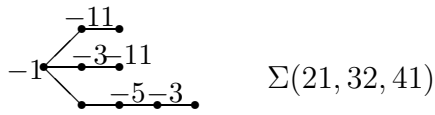
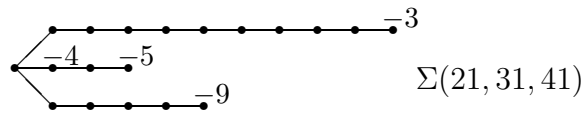
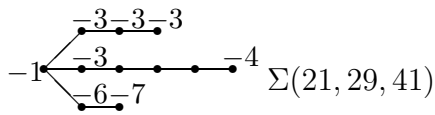

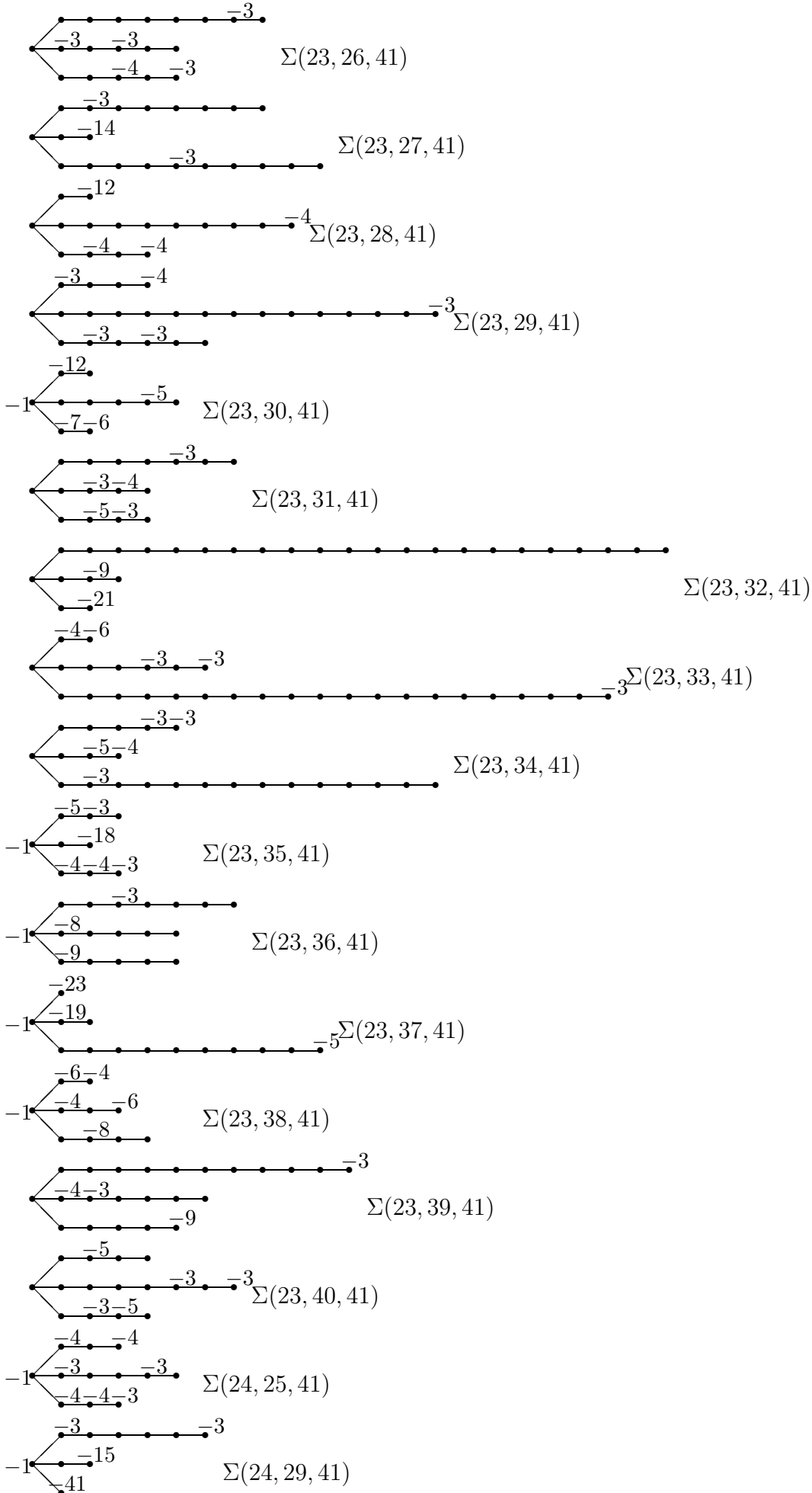

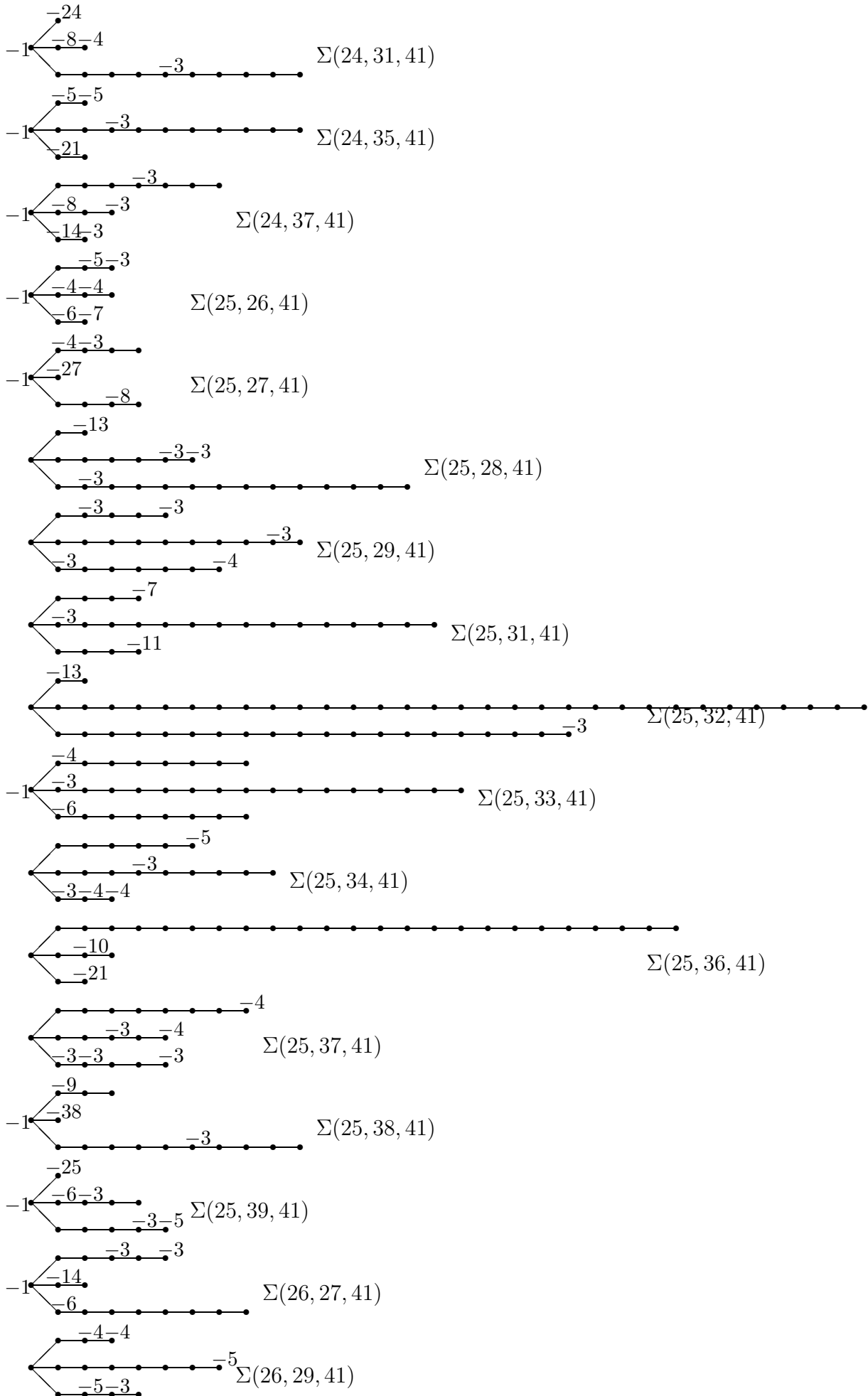

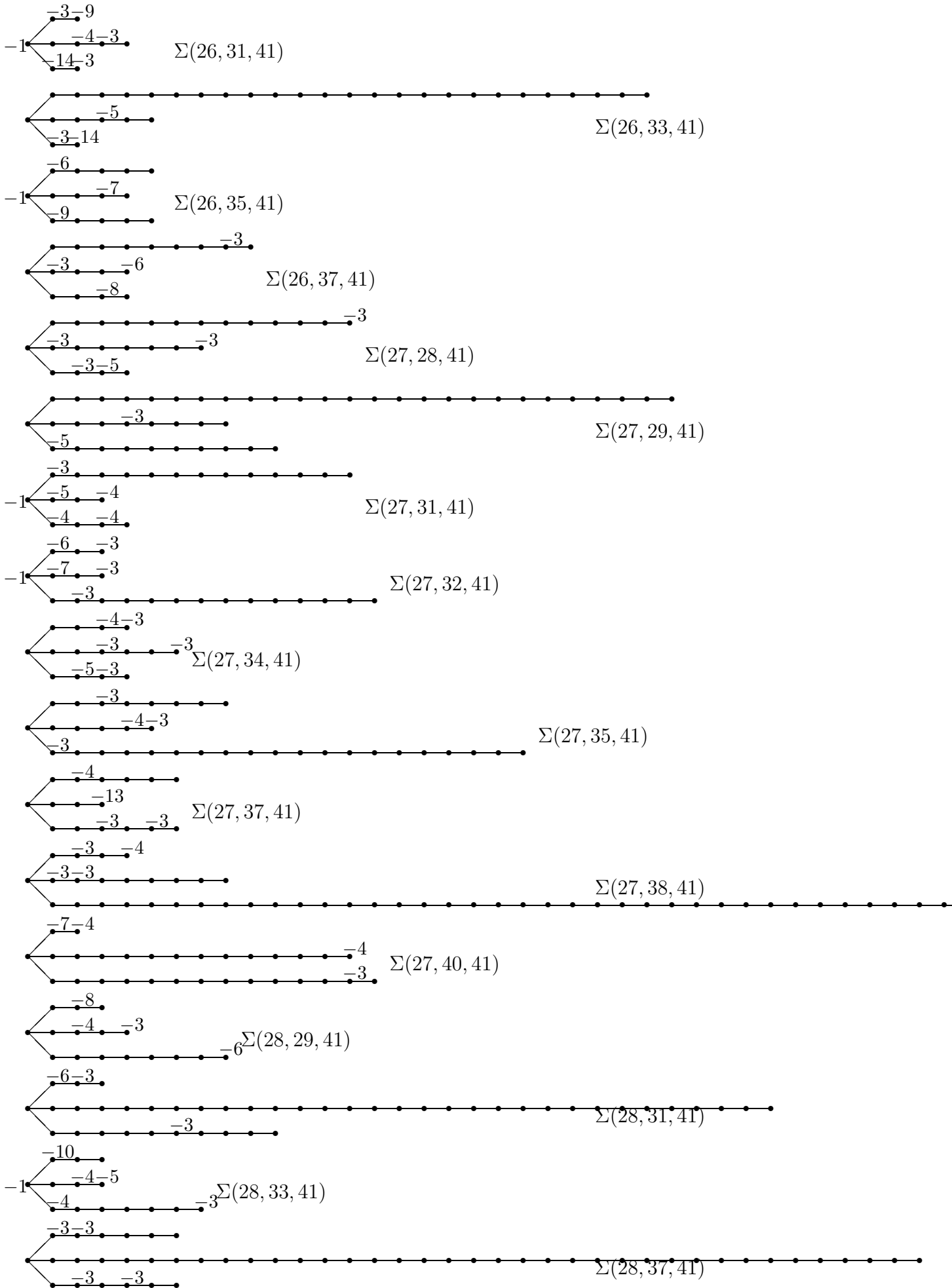

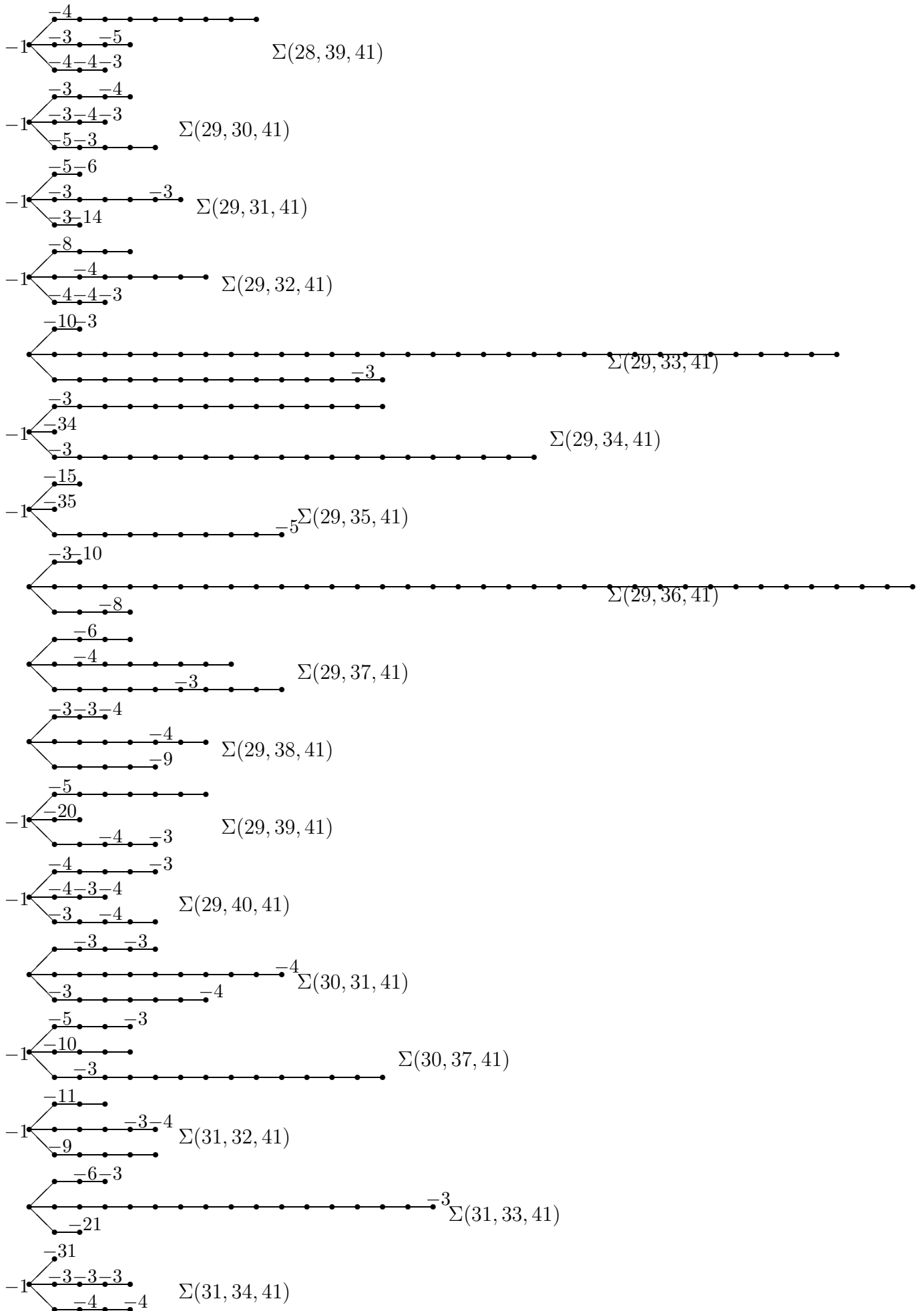

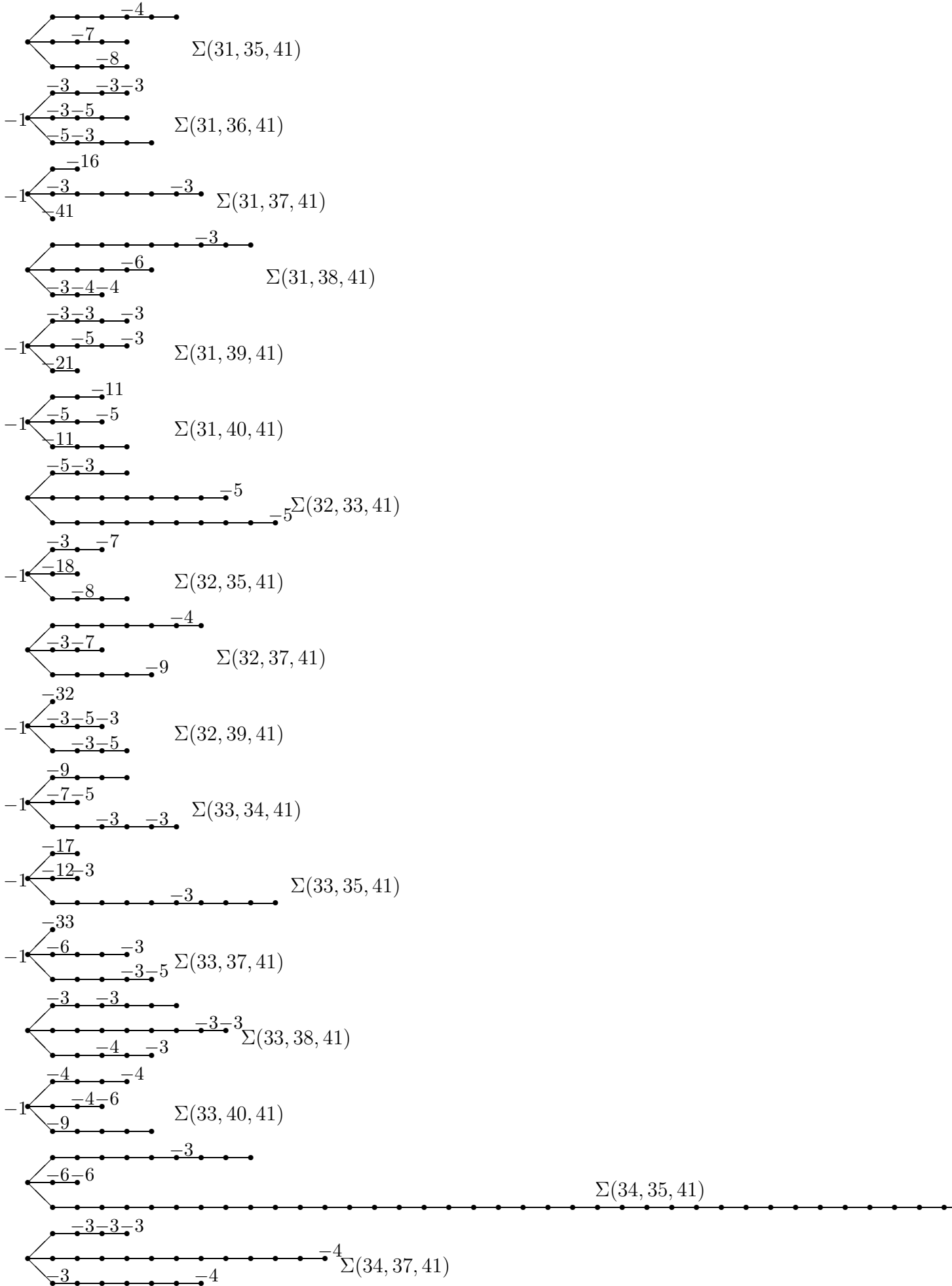

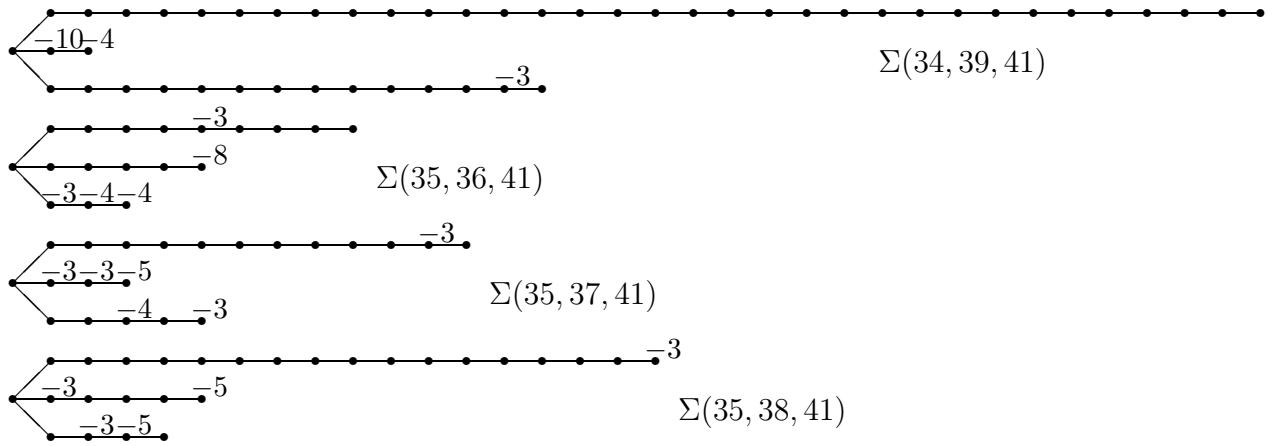

REFERENCES

[NR] W.D.Neumann, F.Raymond, *Seifert manifolds, plumbing, μ -invariant and orientation reversing maps*, Lecture Notes in Math., 664 (1978) 163–196
 [vR] R.von Randow, *Zur Topologie von dreidimensionalen Baummanigfaltigkeiten*, Bonner Math. Schriften 14 (1962)